

AU OPTRONICS CORPORATION

Product Functional Specifications

10.4" SVGA Color TFT-LCD Module

Model Name: B104SN02

V.0

| | |
|-------------------|--------------------|
| Approved by | Prepared by |
| <i>Martin Sun</i> | <i>Cynthia Lin</i> |

GD- MDBU Marketing Division / AU Optronics Corporation

| | |
|----------|-----------------------|
| Customer | Checked & Approved by |
| | |

Version: 0.3
Total Pages: 20
Date: 2003/12/03

Product Functional Specification

10.4 inch SVGA Color TFT LCD Module
Model Name : B104SN02

Preliminary Specification
 Final Specification

Note: This Specification is subject to change without notice.

Record of Revision

| Version | Revise Date | Page | Old Description | New Description | Remark |
|---------|------------------|-------|---|---|--------|
| 0 | 28/May/2003 | 20 | First draft | First draft | |
| 0.1 | 04/July/2003 | 14 | | Add CR min. 250 | |
| | | 14 | | Add Brightness min. 280nit | |
| | | 17 | | Packing: 20pcs | |
| | | 18 | | Add 5.6±0.3 mm dimensions | |
| | | 19 | | Add rear view dimensions | |
| 0.2 | 01/August/2003 | 6 | Pin 18: Aging (High) | Cancel the note for Aging | |
| | | 10 | Input signal timing | Describe the same as B104SN01 | |
| | | 12 | Lamp current (I _L) | Min: 5, Max: 7 | |
| | | 12 | Backlight driving | Note 1& 4: I _L = 6mA | |
| | | 12 | Note 5: Pin no. 1~2 | Pin no. 1~3, CN2: JST BHR-03VS-1 Mating: SM02(8.0)B-BHS-1-TB | |
| | | 17 | Packing form | Add weight, carton outline dimension and drawing | |
| | 12/Augst/2003 | 12 | Note 5: Mating | SM03(4.0)B-BHS-1-TB | |
| 0.3 | 03/December/2003 | 5 | Dimension 11 max. (D) Weight: 510(g) | Dimension 10.6 typ. (D) Weight: 485±10(g) | |
| | | 13 | Contrast ration: 250(min), 350(typ.) | Contrast ration: 400(min), 500(typ.) | |
| | | 13 | Brightness: 280(min), 350(typ.) | Brightness: 320(min), 400(typ.) | |
| | | 13 | White uniformity: 1.43 | White uniformity: 1.3 | |
| | | 18-19 | | Drawing updated | |

Contents:

| | |
|---|------------|
| A. Physical specifications | P5 |
| B. Electrical specifications | P6 |
| 1. Pin assignment..... | P6 |
| 2. Absolute maximum ratings..... | P7 |
| 3. Electrical characteristics..... | P8 |
| a. Typical operating conditions..... | P8 |
| b. Display color v.s. input data signals..... | P9 |
| c. Input signal timing..... | P10 |
| d. Display position..... | P11 |
| e. Backlight driving conditions..... | P12 |
| C. Optical specifications | P13 |
| D. Reliability test items | P15 |
| E. Display quality | P16 |
| F. Handling precaution | P16 |
| G. Packing form | P17 |
| Appendix: | |
| Fig.1 LCM outline dimensions..... | P18 |
| Fig.2 LCM outline dimensions..... | P19 |
| Fig.3 Timing chart. | P20 |

A. Physical specifications

| NO. | Item | Specification | Remark |
|-----|----------------------------|----------------------------------|--------|
| 1 | Display resolution (pixel) | 800(H)×600(V) | |
| 2 | Active area (mm) | 211.2(H)×158.4(V) | |
| 3 | Screen size (inch) | 10.4(Diagonal) | |
| 4 | Pixel pitch (mm) | 0.264(H)×0.264(V) | |
| 5 | Color configuration | R. G. B. Vertical stripe | |
| 6 | Overall dimension (mm) | 243.0(W)×184.0(H)×10.6(D) (typ.) | Note 1 |
| 7 | Weight (g) | 485 ±10 | |

Note 1: Refer to Fig. 1. & 2.

B. Electrical specifications

1. Pin assignment

(1) Input signal interface

| | Symbol | Function | Etc. |
|----|-----------------|--------------------------------|-------------|
| 1 | V _{CC} | +3.3 V power supply | |
| 2 | V _{CC} | +3.3 V power supply | |
| 3 | GND | Ground | |
| 4 | GND | Ground | |
| 5 | RxIN0- | LVDS receiver signal channel 0 | |
| 6 | RxIN0+ | | |
| 7 | GND | Ground | |
| 8 | RxIN1- | LVDS receiver signal channel 1 | |
| 9 | RxIN1+ | | |
| 10 | GND | Ground | |
| 11 | RxIN2- | LVDS receiver signal channel 2 | |
| 12 | RxIN2+ | | |
| 13 | GND | Ground | |
| 14 | CKIN- | LVDS receiver signal clock | |
| 15 | CKIN+ | | |
| 16 | GND | Ground | |
| 17 | NC | No Connection | |
| 18 | NC | No Connection | |
| 19 | GND | Ground | |
| 20 | GND | Ground | |

CN1 (20P) connector : HRS DF 19K-20P-1H or compatible

(2) LVDS transmitter/receiver signal mapping

| | Symbol | Function | |
|---------|--------|------------------|--------------------------|
| TxIN0 | R0 | Red data (LSB) | 6 bit red display data |
| TxIN1 | R1 | Red data | |
| TxIN2 | R2 | Red data | |
| TxIN3 | R3 | Red data | |
| TxIN4 | R4 | Red data | |
| TxIN5 | R5 | Red data (MSB) | |
| TxIN6 | G0 | Green data (LSB) | 6 bit green display data |
| TxIN7 | G1 | Green data | |
| TxIN8 | G2 | Green data | |
| TxIN9 | G3 | Green data | |
| TxIN10 | G4 | Green data | |
| TxIN11 | G5 | Green data (MSB) | |
| TxIN12 | B0 | Blue data (LSB) | 6 bits blue display data |
| TxIN13 | B1 | Blue data | |
| TxIN14 | B2 | Blue data | |
| TxIN15 | B3 | Blue data | |
| TxIN16 | B4 | Blue data | |
| TxIN17 | B5 | Blue data (MSB) | |
| TxIN18 | Hs | Horizontal sync. | |
| TxIN19 | Vs | Vertical sync. | |
| TxIN20 | DE | Data enable | |
| TxCLKIN | CLK | Clock | Dot clock |

2. Absolute maximum ratings
(GND = 0 V)

| Parameter | Symbol | Values | | Unit | Remark |
|-----------------------|----------|--------|--------------|----------|---------|
| | | Min. | Max. | | |
| Power voltage | V_{CC} | -0.3 | 4 | V_{DC} | At 25°C |
| Input signal voltage | V_{LH} | -0.3 | $V_{CC}+0.3$ | V_{DC} | At 25°C |
| Operating temperature | T_{op} | 0 | +50 | °C | Note 1 |
| Storage temperature | T_{ST} | -20 | +60 | °C | Note 1 |

Note 1: The relative humidity must not exceed 90% non-condensing at temperatures of 40°C or less. At temperatures greater than 40°C, the wet bulb temperature must not exceed 39°C. When operate at low temperatures, the brightness of CCFL will drop and the life time of CCFL will be reduced.

Note 2: The unit should not be exposed to corrosive chemicals.

3. Electrical characteristics

a. Typical operating conditions

| | Item | Symbol | Min. | Typ. | Max. | Unit | Remark |
|----------------------|----------------------|------------|-------------|------|--------------|--------|--------|
| Power supply voltage | Input voltage | V_{CC} | 3.0 | 3.3 | 3.6 | V | |
| | Current consumption | I_A | | 230 | | mArms | Note 1 |
| | | I_B | | | 260 | 310 | |
| | Inrush current | I_{RUSH} | - | - | 1500 | mApeak | Note 2 |
| Internal logic | Low voltage | V_{IL} | 0 | - | $0.3 V_{CC}$ | | |
| | High voltage | V_{IH} | $0.7V_{CC}$ | - | V_{CC} | | |
| | Power ripple voltage | V_{RP} | - | - | 100 | mVp-p | |

Note 1: Effective value (mArms) at $V_{CC} = 3.3 V/25^{\circ}C$.

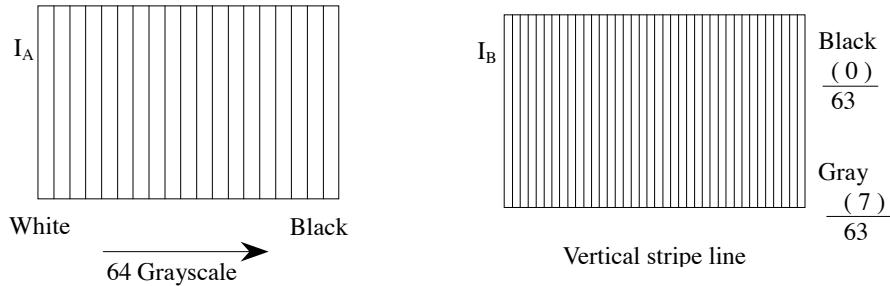

Note 2: Refer to the following power-on condition.

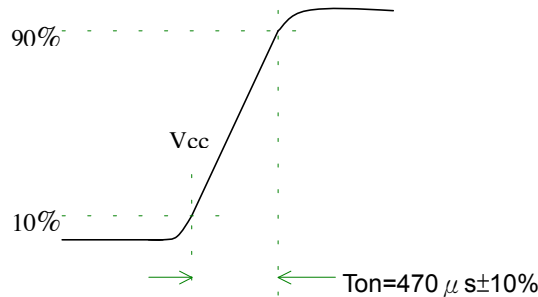

Sequence of Power-on/off and signal-on/off

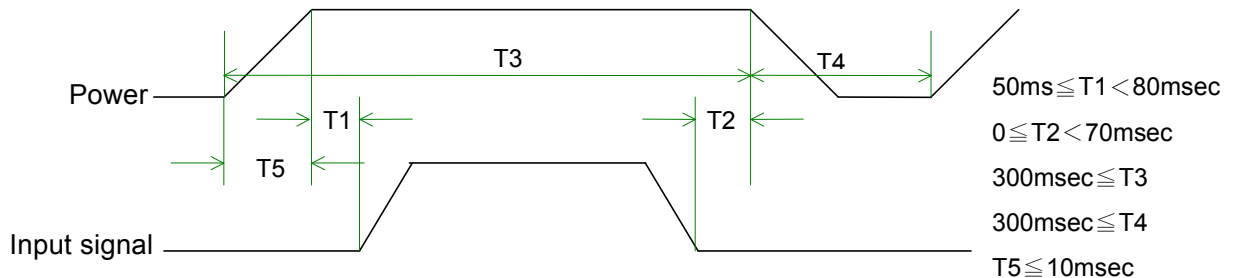

Apply the lamp voltage within the LCD operating range. When the backlight turns on before the LCD operation or the LCD turns off before the backlight turns off, the display may momentarily become abnormal.

| |
|---------|
| Caution |
|---------|

The above on/off sequence should be applied to avoid abnormal function in the display.
 In case of handling:
 Make sure to turn off the power when you plug the cable into the input connector or pull the cable out of the connector.

b. Display color v.s. input data signals

| Display colors | | Data signal (0 : Low level, 1: High level) | | | | | | | | | | | | | | | | | |
|-----------------|---------|--|----|----|----|----|----|----|----|----|----|----|----|----|----|----|----|----|----|
| | | R5 | R4 | R3 | R2 | R1 | R0 | G5 | G4 | G3 | G2 | G1 | G0 | B5 | B4 | B3 | B2 | B1 | B0 |
| Basic colors | Black | 0 | 0 | 0 | 0 | 0 | 0 | 0 | 0 | 0 | 0 | 0 | 0 | 0 | 0 | 0 | 0 | 0 | 0 |
| | Blue | 0 | 0 | 0 | 0 | 0 | 0 | 0 | 0 | 0 | 0 | 0 | 0 | 1 | 1 | 1 | 1 | 1 | 1 |
| | Red | 1 | 1 | 1 | 1 | 1 | 1 | 0 | 0 | 0 | 0 | 0 | 0 | 0 | 0 | 0 | 0 | 0 | 0 |
| | Magenta | 1 | 1 | 1 | 1 | 1 | 1 | 0 | 0 | 0 | 0 | 0 | 0 | 1 | 1 | 1 | 1 | 1 | 1 |
| | Green | 0 | 0 | 0 | 0 | 0 | 0 | 1 | 1 | 1 | 1 | 1 | 1 | 0 | 0 | 0 | 0 | 0 | 0 |
| | Cyan | 0 | 0 | 0 | 0 | 0 | 0 | 1 | 1 | 1 | 1 | 1 | 1 | 1 | 1 | 1 | 1 | 1 | 1 |
| | Yellow | 1 | 1 | 1 | 1 | 1 | 1 | 1 | 1 | 1 | 1 | 1 | 1 | 0 | 0 | 0 | 0 | 0 | 0 |
| | White | 1 | 1 | 1 | 1 | 1 | 1 | 1 | 1 | 1 | 1 | 1 | 1 | 1 | 1 | 1 | 1 | 1 | 1 |
| Red grayscale | Black | 0 | 0 | 0 | 0 | 0 | 0 | 0 | 0 | 0 | 0 | 0 | 0 | 0 | 0 | 0 | 0 | 0 | 0 |
| | | 0 | 0 | 0 | 0 | 0 | 1 | 0 | 0 | 0 | 0 | 0 | 0 | 0 | 0 | 0 | 0 | 0 | 0 |
| | Dark | 0 | 0 | 0 | 0 | 1 | 0 | 0 | 0 | 0 | 0 | 0 | 0 | 0 | 0 | 0 | 0 | 0 | 0 |
| | ↑ | | | | | | | | | | | | | | | | | | |
| | ↓ | | | | | | | | | | | | | | | | | | |
| | bright | 1 | 1 | 1 | 1 | 0 | 1 | 0 | 0 | 0 | 0 | 0 | 0 | 0 | 0 | 0 | 0 | 0 | 0 |
| Green grayscale | Black | 0 | 0 | 0 | 0 | 0 | 0 | 0 | 0 | 0 | 0 | 0 | 0 | 0 | 0 | 0 | 0 | 0 | 0 |
| | | 0 | 0 | 0 | 0 | 0 | 0 | 0 | 0 | 0 | 0 | 1 | 0 | 0 | 0 | 0 | 0 | 0 | 0 |
| | Dark | 0 | 0 | 0 | 0 | 0 | 0 | 0 | 0 | 0 | 1 | 0 | 0 | 0 | 0 | 0 | 0 | 0 | 0 |
| | ↑ | | | | | | | | | | | | | | | | | | |
| | ↓ | | | | | | | | | | | | | | | | | | |
| | bright | 0 | 0 | 0 | 0 | 0 | 0 | 1 | 1 | 1 | 1 | 0 | 1 | 0 | 0 | 0 | 0 | 0 | 0 |
| Blue grayscale | Black | 0 | 0 | 0 | 0 | 0 | 0 | 0 | 0 | 0 | 0 | 0 | 0 | 0 | 0 | 0 | 0 | 0 | 0 |
| | | 0 | 0 | 0 | 0 | 0 | 0 | 0 | 0 | 0 | 0 | 0 | 0 | 0 | 0 | 0 | 0 | 0 | 1 |
| | Dark | 0 | 0 | 0 | 0 | 0 | 0 | 0 | 0 | 0 | 0 | 0 | 0 | 0 | 0 | 0 | 0 | 1 | 0 |
| | ↑ | | | | | | | | | | | | | | | | | | |
| | ↓ | | | | | | | | | | | | | | | | | | |
| | bright | 0 | 0 | 0 | 0 | 0 | 0 | 0 | 0 | 0 | 0 | 0 | 0 | 1 | 1 | 1 | 1 | 0 | 1 |
| Blue grayscale | | 0 | 0 | 0 | 0 | 0 | 0 | 0 | 0 | 0 | 0 | 0 | 1 | 1 | 1 | 1 | 1 | 0 | |
| | | 0 | 0 | 0 | 0 | 0 | 0 | 0 | 0 | 0 | 0 | 0 | 1 | 1 | 1 | 1 | 1 | 0 | |
| | | 0 | 0 | 0 | 0 | 0 | 0 | 0 | 0 | 0 | 0 | 0 | 1 | 1 | 1 | 1 | 1 | 1 | |
| | Blue | 0 | 0 | 0 | 0 | 0 | 0 | 0 | 0 | 0 | 0 | 0 | 1 | 1 | 1 | 1 | 1 | 1 | |

Note : Each basic color can be displayed in 64 gray scales using the 6 bit data signals. By combining the 18-bit data signals(R, G, B), the 262, 144 colors can be achieved on the display.

c. Input signal timing

Timing diagrams of input signal are shown in Fig 2.

(1) Timing characteristics of input signals

(a) DE mode

| Item | Symbol | Min. | Typ. | Max. | Unit | Remark |
|---------------------|--------|------|------|------|------|--------|
| Clock frequency | Fck | 38 | 40 | 48 | MHz | |
| Horizontal blanking | Thb1 | 50 | 256 | 500 | Clk | |
| Vertical blanking | Tvb1 | 10 | 28 | 150 | Th | |

(b) HV mode

| Item | Symbol | Min. | Typ. | Max. | Unit | Remark |
|-------------------------|--------|------|------|------|------|--------|
| Clock frequency | Fck | 38 | 40 | 48 | MHz | |
| Hsync period | Th | 850 | 1056 | 1300 | Clk | |
| Hsync pulse width | Thw | 10 | 128 | - | Clk | |
| Hsync front porch | Thf | 15 | 40 | - | Clk | |
| Hsync back porch | Thb | 10 | 88 | - | Clk | |
| Hsync blanking | Thb1 | 50 | 256 | 500 | Clk | |
| Vsync period | Tv | 610 | 628 | 750 | Th | |
| Vsync pulse width | Tvw | 1 | 4 | - | Th | |
| Vsync front porch | Tvf | 0 | 1 | - | Th | |
| Vsync blanking | Tvb1 | 10 | 28 | 150 | Th | |
| Hsync/Vsync phase shift | Tvpd | 2 | 320 | - | Clk | |

| Item | Symbol | Value | Unit | Description |
|--------------------------|--------|-------|------|--|
| Horizontal display start | The | 218 | Clk | After falling edge of Hsync, counting 218clk, then getting valid data from 219th clk's data. |
| Vertical display start | Tve | 25 | Th | After falling edge of Vsync, counting 25th, then getting 26th Th's data. |

(2) The timing condition of LVDS

| Item | Symbol | Min. | Typ. | Max. | Unit |
|-------------------------------|--------|-------------------|------|-------------------------|------|
| The differential level | VID | 0.1 | - | 0.6 | V |
| The common mode input voltage | VIC | $\frac{ VID }{2}$ | - | $2.4 - \frac{ VID }{2}$ | V |
| The input setup time | tsu1 | 500 | - | - | ps |
| The input hold time | th1 | 500 | - | - | ps |

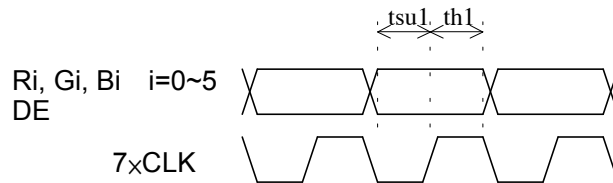
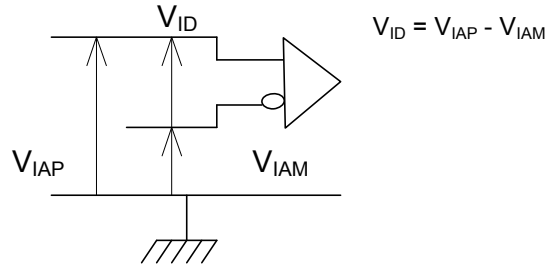

d. Display position

| | | | | | | |
|------------|------------|-------|------------|-------|--------------|--------------|
| D(1,1) | D(2,1) | | D(X,1) | | D(799,1) | D(800,1) |
| D(1,2) | D(2,2) | | D(X,2) | | D(799,2) | D(800,2) |
| ⋮ | | | ⋮ | | ⋮ | ⋮ |
| D(1,Y) | D(2,Y) | | D(X,Y) | | D(799,Y) | D(800,Y) |
| ⋮ | | | ⋮ | | ⋮ | ⋮ |
| D(1,599) | D(2,599) | | D(X,599) | | D(799,599) | D(800,599) |
| D(1,600) | D(2,600) | | D(X,600) | | D(799,600) | D(800,600) |

e. Backlight driving conditions

| Parameter | Symbol | Min. | Typ. | Max. | Unit | Remark |
|-----------------------|--------|------|--------|------|-------|-----------|
| Lamp voltage | V_L | 520 | 580 | 630 | Vrms | Note 1 |
| Lamp current | I_L | 5 | 6 | 7 | mArms | Note 1 |
| Power consumption | P_L | - | 8.3 | - | W | Note 2 |
| Lamp starting voltage | V_S | - | - | 1050 | Vrms | T=0°C |
| | | - | - | 800 | | T=25°C |
| Frequency | F_L | - | 50 | - | KHz | Note 3 |
| Lamp life time | L_L | - | 50,000 | - | Hr | Note 1, 4 |

Note 1: T= 25°C, $I_L = 6\text{mA}$

Note 2: Inverter should be designed with the characteristic of lamp. When you are designing the inverter, the output voltage of the inverter should comply with the following conditions.

- (1). The area under the positive and negative cycles of the waveform of the lamp current and lamp voltage should be area symmetric(the symmetric ratio should be larger than 90%).
- (2). There should not be any spikes in the waveform.
- (3). The waveform should be sine wave as possible.
- (4). Lamp current should not exceed the maximum value within the operating Temperature (It is prohibited to over the maximum lamp current even if operated in The non-guaranteed temperature). When lamp current over the maximum value for a long time, it may cause fire. Therefore, it is recommend that the inverter should have the current limited circuit.

Note 3: Lamp frequency may produce interference with horizontal synchronous frequency and this may cause line flow on the display. Therefore lamp frequency shall be detached from the horizontal synchronous frequency and its harmonics as far as possible in order to avoid interference.

Note 4: Brightness ($I_L=6\text{mA}$) to be decrease to the 50% of the initial value.

Note 5: CN2 connector (backlight): JST BHR-03VS-1
Mating connector: JST SM03(4.0)B-BHS-1-TB

| Pin no. | Symbol | Function | Remark |
|---------|--------|-------------------------|--------------------|
| 1 | L | CCFL power supply(GND) | Cable color: White |
| 2 | H | CCFL power supply(H.V.) | Cable color: Pink |
| 3 | H | CCFL power supply(H.V.) | Cable color: Pink |

C. Optical specifications (Note 1, Note 2)

| Item | Symbol | Condition | Specification | | | Unit | Remark |
|---|------------|--------------------|------------------|----------------------|------------------|------|--------------|
| | | | Min. | Typ. | Max. | | |
| Response time Rising time Falling time | Tr Tf | $\theta = 0^\circ$ | - - | 10 25 | 20 30 | ms | Note 4 |
| Contrast ratio | CR | $\theta = 0^\circ$ | 400 | 500 | - | | Note 3,5 |
| Viewing angle Top Bottom Left Right | | $CR \geq 10$ | - - - - | 40 60 60 60 | - - - - | deg. | Note 3,6 |
| Brightness | Y_L | $\theta = 0^\circ$ | 320 | 400 | - | nit | Note 3,7,8,9 |
| Color chromaticity(CIE) | Wx | $\theta = 0^\circ$ | 0.290 | 0.320 | 0.350 | | Note 3,8,9 |
| | Wy | | 0.300 | 0.330 | 0.360 | | |
| | Rx | | 0.540 | 0.570 | 0.600 | | |
| | Ry | | 0.290 | 0.320 | 0.350 | | |
| | Gx | | 0.270 | 0.300 | 0.330 | | |
| | Gy | | 0.530 | 0.560 | 0.590 | | |
| | Bx | | 0.115 | 0.145 | 0.175 | | |
| | By | | 0.100 | 0.130 | 0.160 | | |
| White uniformity | δ_w | | - | - | 1.3 | | Note 3,9,10 |

Note 1: Ambient temperature = 25°C.

Note 2: To be measured in dark room after backlight warm up 30 minutes.

Note 3: To be measured with a viewing cone of 1° by Topcon luminance meter BM-5A.

Note 4: Definition of response time:

The output signals of BM-7 are measured when the input signals are changed from "Black" to "White" (falling time) and from "White" to "Black" (rising time), respectively. The response time means the interval between the 10% and 90% of amplitudes. Refer to figure as below.

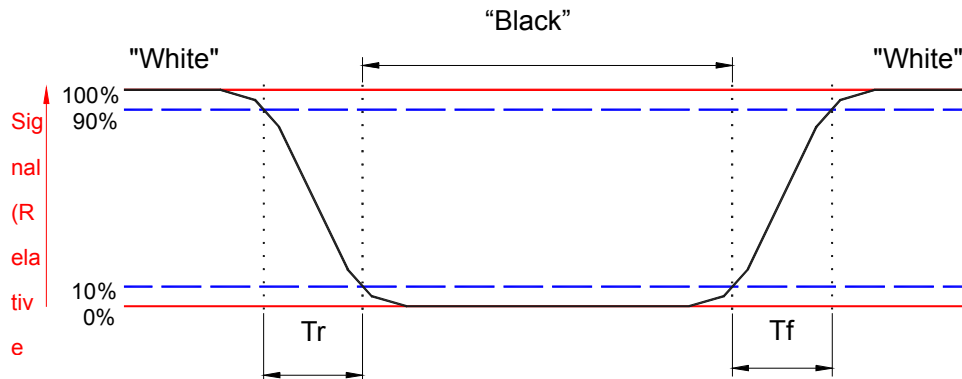

Note 5. Definition of contrast ratio:

Contrast ratio is calculated with the following formula.

$$\text{Contrast ratio (CR)} = \frac{\text{Luminance on the white raster}}{\text{Luminance on the black raster}}$$

Note 6: Definition of viewing angle:

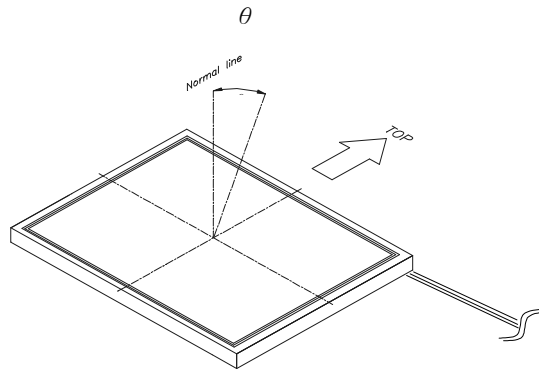

Note 7: Definition of the 9 points (from A to I) on panel, refer to figure as below

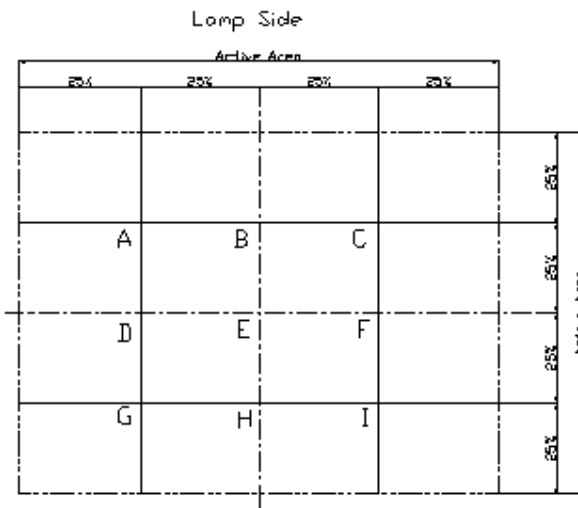

Note 8: Definition of brightness: To measure at center point of the screen (E)

Note 9: Driving conditions for CCFL : $I_L=6$ mA, 50KHz Frequency

Note 10: Definition of white uniformity:

$$\delta w = \frac{\text{Maximum Luminance of nine points (brightness)}}{\text{Minimum Luminance of nine points (brightness)}}$$

D. Reliability test items (Note 1)

| Test tem | Test Condition | Remark |
|--|---|--------------|
| High temperature storage | 60°C, 240Hrs | Note 1, 2, 3 |
| Low temperature storage | -20°C, 240Hrs | Note 1, 2, 3 |
| High temperature & high humidity operation | 40°C, 90%RH, 240Hrs (No condensation) | Note 1, 2, 3 |
| High temperature operation | 50°C, 240Hrs | Note 1, 2, 3 |
| Low temperature operation | 0°C, 240Hrs | Note 1, 2, 3 |
| Electrostatic discharge (non-operation) | 150 pF, 150 Ω, 10kV, 1 second, 9 position on the panel, 10 times each place | Note 3 |
| Vibration (non-operation) | 1.5G, 10Hz ~ 200Hz ~ 10Hz 30 minutes for each Axis (X, Y, Z) | Note 1, 2, 3 |
| Mechanical shock (non-operation) | 50G/20ms, ±X, ±Y, ±Z half-Sin, one time | Note 1, 2, 3 |
| Thermal shock (non-operation) | 1. -20°C ±3°C ... 30minutes 60°C ±3°C ... 30minutes 2. 100 cycles 3. Temperature transition time within 5 minutes | Note 1, 2, 3 |

Note 1: Evaluation should be tested after storage at room temperature for one hour.

Note 2: There should be no change which might affect the practical display function when the display quality test is conducted under normal operating condition.

Note 3: Judgement: 1. Function OK

2. No serious image quality degradation

E. Display quality

The display quality of the color TFT-LCD module should be in compliance with the AUO's OQC inspection standard.

F. Handling precaution

The Handling of the TFT-LCD should be in compliance with the AUO's handling principle standard.

G. Packing form:

NOTE:

- 1. Max. Capacity: 20 pcs LCD Modules / Per Carton**
- 2. Max. Weight: 12Kg / Per Carton**
- 3. The outside dimension of carton is 570mm(L)x 270mm(W)x 345mm(H)**

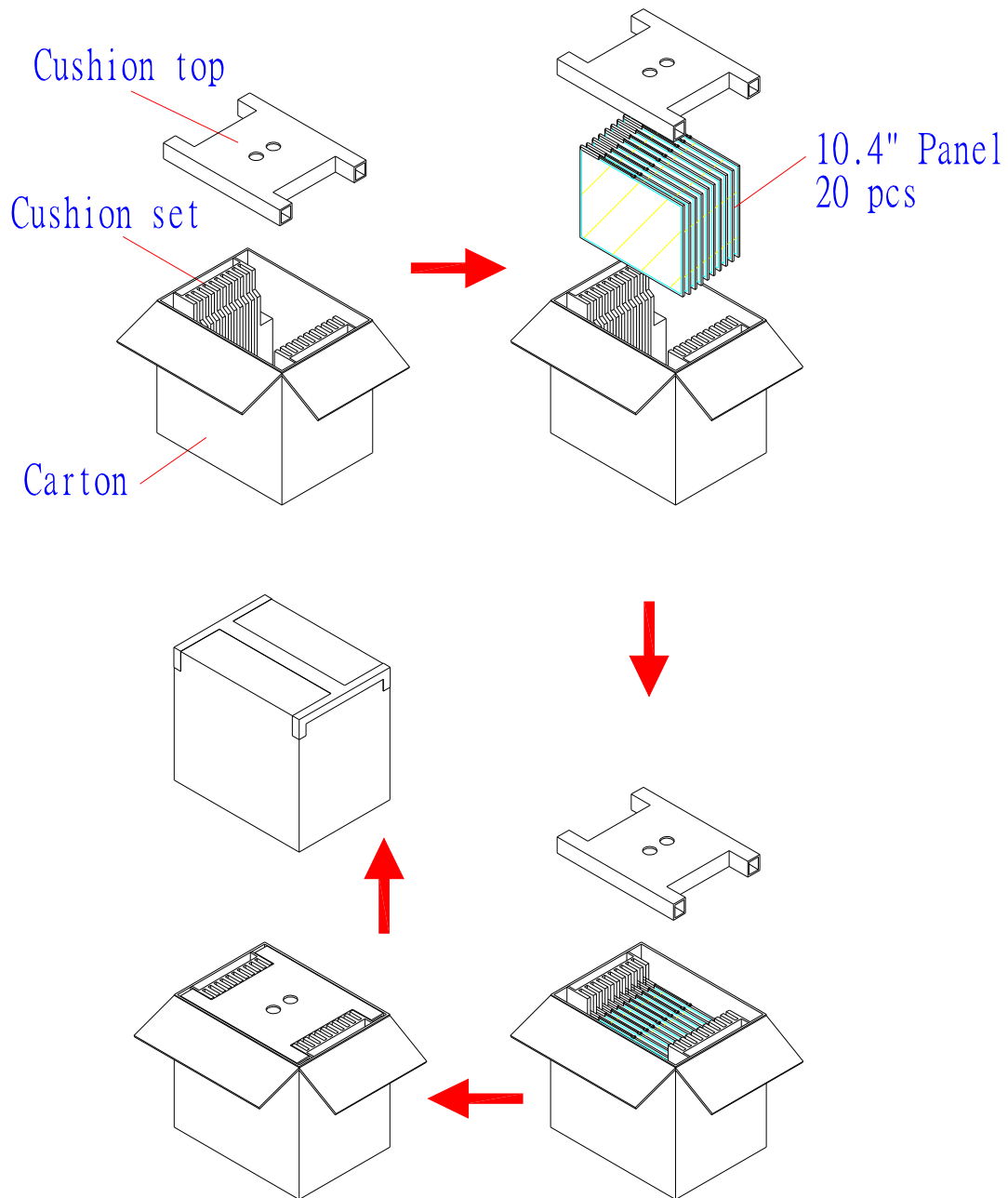

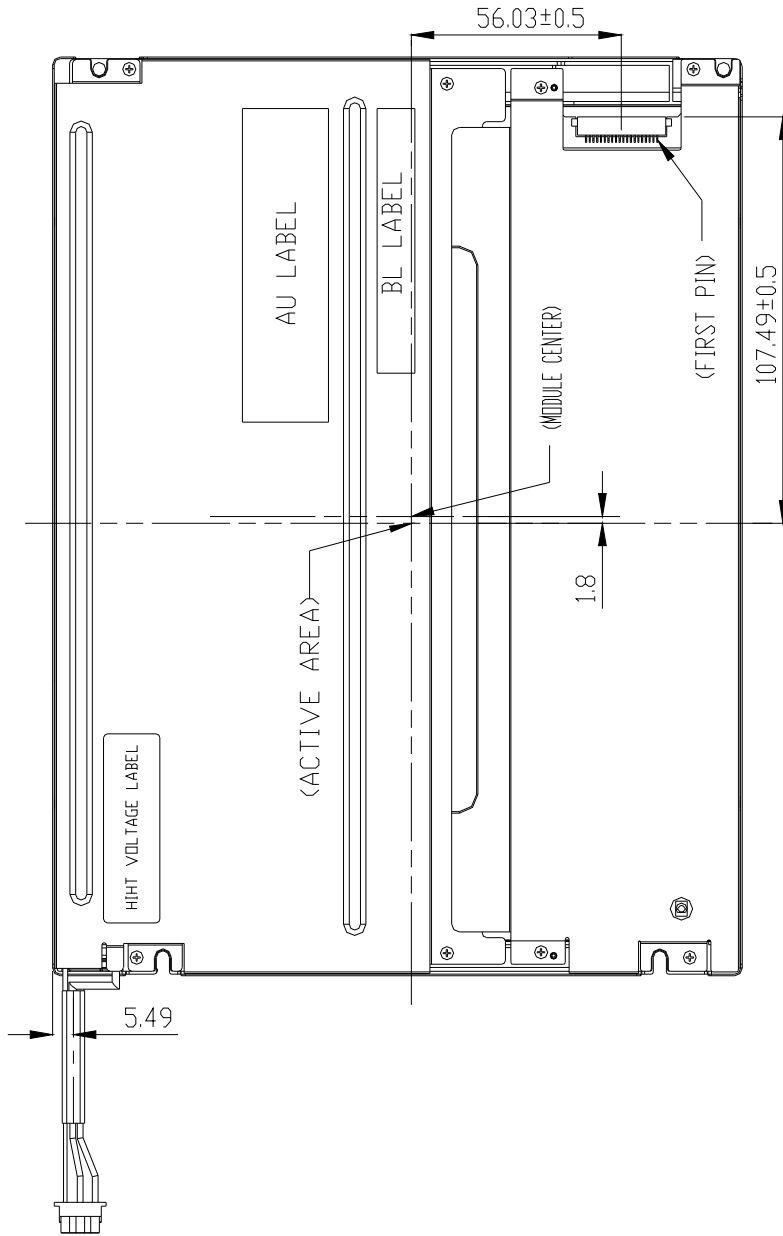

Fig.2 LCM outline dimensions

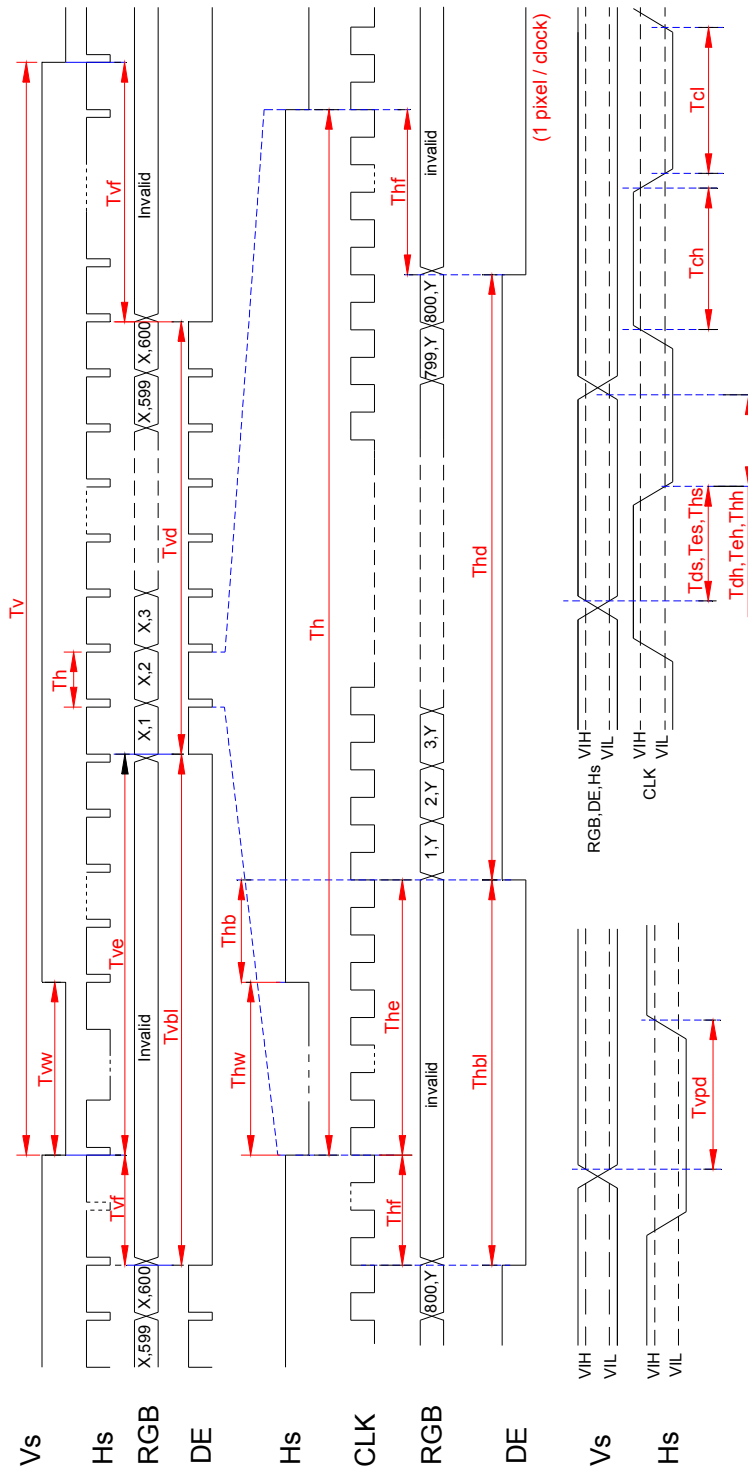

Fig.3 Timing chart