



Version	Final
Total pages	20
Date	22 Aug, 2007

Product Specification

6.5" color TFT-LCD module

MODEL NAME: C065GW02 V1

- () Draft Specification
- (◆) Final Specification

© 2006AU Optronics
All Rights Reserved,
Do Not Copy.

Note: The content of this specification is subject to change without prior notice.



Contents:

A. Physical specification..... P3

B. Electrical specifications..... P4

 1. Pin assignment..... P4

 a. TFT-LCD panel driving section..... P4

 b. Backlight driving section..... P5

 2. Absolute maximum ratings..... P5

 3. Environment conditions..... P5

 4. Electrical characteristics..... P6

 a. Typical operating conditions..... P6

 b. Current consumption..... P6

 c. Backlight driving conditions..... P6

 5. AC Timing..... P7

 a. Timing conditions..... P7

 b. Timing diagram..... P7

C. Optical specifications..... P8

D. Reliability test items..... P10

Appendix:

Fig.1 Outline dimension of TFT-LCD module.....	P11
Fig.2 Package drawing of TFT-LCD module.....	P12
Fig.3 Sampling clock timing.....	P13
Fig.4 Horizontal display timing range.....	P14
Fig.5-(a) Horizontal timing.....	P15
Fig.5- (b) Detail horizontal timing.....	P16
Fig.6 Vertical shift clock timing.....	P17
Fig.7-(a) Vertical timing (From up to down).....	P18
Fig.7-(b) Vertical timing (From down to up).....	P19
Appendix 1: CCFL connector – JST BHR(03)VS-1.....	P20

A. Physical specifications

NO.	Item	Specification	Remark
1	Display resolution(dot)	400RGB(W)×234(H)	
2	Display Active area(mm)	143.4(W)×79.326(H)	
3	Screen size(inch)	6.5(Diagonal)	
4	Dot pitch(mm)	0.1195(W)×0.339 (H)	
5	Color configuration	R. G. B. stripe	
6	Overall dimension(mm)	155(W)×90.83(H)×8.15(D)	Note 1
7	Weight(g)	150±10(g)	
8	Surface treatment	AG(25%) with SWV film	
10	Backlight unit	L type CCFL lamp	

Note 1: Refer to Fig. 1

B. Electrical specifications

1. Pin assignment

a. TFT-LCD panel driving section

Pin no	Symbol	I/O	Description	Remark
1	GND	-	Ground for logic circuit	
2	V _{CC}	I	Supply voltage of logic control circuit for scan driver	
3	V _{GL}	I	Negative power for scan driver	
4	V _{GH}	I	Positive power for scan driver	
5	STVR	I/O	Vertical start pulse	Note 1
6	STVL	I/O	Vertical start pulse	Note 1
7	CKV	I	Shift clock input for scan driver	
8	U/D	I	UP/DOWN scan control input	Note 1,2
9	OEV	I	Output enable input for scan driver	
10	VCOM	I	Common electrode driving signal	
11	VCOM	I	Common electrode driving signal	
12	L/R	I	LEFT/RIGHT scan control input	Note 1,2
13	MOD	I	Sequential sampling and simultaneous sampling setting	Note 3
14	OEH	I	Output enable input for data driver	
15	STHL	I/O	Start pulse for horizontal scan line	Note 1
16	STHR	I/O	Start pulse for horizontal scan line	Note 1
17	CPH3	I	Sampling and shifting clock pulse for data driver	
18	CPH2	I	Sampling and shifting clock pulse for data driver	
19	CPH1	I	Sampling and shifting clock pulse for data driver	
20	V _{CC}	I	Supply voltage of logic control circuit for data driver	
21	GND	-	Ground for logic circuit	
22	VR	I	Alternated video signal input(Red)	
23	VG	I	Alternated video signal input(Green)	
24	VB	I	Alternated video signal input(Blue)	
25	AV _{DD}	I	Supply voltage for analog circuit	
26	AV _{SS}	-	Ground for analog circuit	

Note 1: Selection of scanning mode (please refer to the following table)

Setting of scan control input		IN/OUT state for start pulse				Scanning direction
U/D	L/R	STVR	STVL	STHR	STHL	
GND	V _{CC}	OUT	IN	OUT	IN	From up to down, and from left to right.
V _{CC}	GND	IN	OUT	IN	OUT	From down to up, and from right to left.
GND	GND	OUT	IN	IN	OUT	From up to down, and from right to left.
V _{CC}	V _{CC}	IN	OUT	OUT	IN	From down to up, and from left to right.

IN: Input; OUT: Output.

Note 2: Definition of scanning direction. Refer to figure as below:

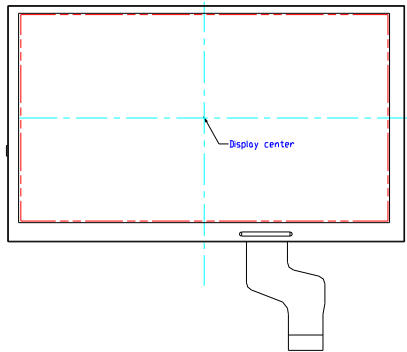

Note 3: MOD = H: Simultaneous sampling. MOD = L: Sequential sampling.
 Please set CPH2 and CPH3 to GND when MOD = H.

b. Backlight driving section (Refer to Fig. 1)

No.	Symbol	I/O	Description	Remark
1	HI	I	Power supply for backlight unit (High voltage)	
2	GND	-	Ground for backlight unit	

Note 1: Connector Type: JST-03VS-1 (3pin type), please refer Page 21.

Note 2: Shrouded header: SM03(4.0)B-BHS-1-TB

2. Absolute maximum ratings

Item	Symbol	Condition	Min.	Max.	Unit	Remark
Power voltage	V_{CC}	GND=0	-0.3	7	V	
	AV_{DD}	$AV_{SS}=0$	-0.3	7	V	
	V_{GH}	GND=0	-0.3	18	V	
	V_{GL}		-15	0.3	V	
	$V_{GH} - V_{GL}$		-	33	V	
Input signal voltage	V_i		-0.3	$AV_{DD}+0.3$	V	Note 1
	V_l		-0.3	$V_{CC}+0.3$	V	Note 2
	VCOM		-2.9	5.2	V	

Note 1: VR, VG, VB.

Note 2: STHL, STHR, OEH, L/R, CPH1~CPH3, STVR, STVL, OEV, CKV, U/D.

3. Environment condition

Item		Condition	Spec.	Remark
Operating temperature	Panel with lighting BLU	Panel surface temperature	-30~ 85°C	Note 1,2,3
Storage temperature	Panel only	Ambient temperature	-40 ~95°C	

Note 1: Under the condition of the operating temperature, the panel would be function normal for the visual display only. For contrast, response time, and other factors related to display quality, determine temperature using the formula $T_a=25^{\circ}C$

Note 2: Panel surface temperature is defined as the maximum temperature of panel surface. In general, the lamp side temperature is higher than non-lamp side around 10 °C

Note 3: The backlight has been turned on before running about condition.

4. Electrical characteristics

a. Typical operating conditions (GND=AVss=0V, Note 4)

Item	Symbol	Min.	Typ.	Max.	Unit	Remark	
Power supply	V _{CC}	3	3.3	5.2	V		
	AV _{DD}	4.8	5	5.2	V		
	V _{GH}	14.3	15	15.7	V		
	V _{GL}	-10.5	-10	-9.5	V		
Video signal amplitude (VR, VG, VB)	V _{iA}	0.4	-	AV _{DD} -0.4	V	Note 1	
	V _{iAC}	-	3	-	V	AC component	
	V _{iDC}	-	AV _{DD} /2	-	V	DC component	
VCOM	V _{CAC}	5.3	5.6	5.9	Vp-p	AC component	
	V _{CDC}	1.6	1.9	2.2	V	DC component	
Input signal voltage	H Level	V _{IH}	0.8V _{CC}	-	V _{CC}	V	Note 2
	L Level	V _{IL}	0	-	0.2V _{CC}		

Note 1: Refer to Fig.4- (a).

Note 2: STHL, STHR, OEH, L/R, CPH1~CPH3, STVR, STVL, OEV, CKV, U/D.

Note 3: Be sure to apply GND, V_{CC} and V_{GL} to the LCD first, and then apply V_{GH}.

b. Current consumption (GND=AVss=0V)

Parameter	Symbol	Condition	Min.	Typ.	Max.	Unit	Remark
Current for driver	I _{GH}	V _{GH} =15V	-	0.052	0.1	mA	
	I _{GL}	V _{GL} =-10V	-	0.049	0.1	mA	
	I _{CC}	V _{CC} =3.3V	-	1.03	1.85	mA	
	I _{DD}	AV _{DD} =5V	-	5.05	6	mA	

c. Backlight driving conditions

Parameter	Symbol	Min.	Typ.	Max.	Unit	Remark
Lamp voltage	V _L	-	510	560	Vrms	
Lamp current	I _L	-	6	6.5	mArms	
Frequency	F _L	-	60	80	kHz	Note 4
Lamp starting voltage	V _S	-	-	1,000	Vrms	Note 1,5
		-	-	1,300	Vrms	Note 2,5
		-	-	1580	Vrms	Note 3,5
Lamp life time		10,000	-	-	Hr	Note 6

Note 1: Ta = 25°C .

Note 2: Ta = 0°C .

Note 3: Ta = -30°C .

Note 4: The lamp frequency should be selected as different as possible from display horizontal synchronous signal to avoid interference.

Note 5: For starting the backlight unit, the output voltage of DC/AC's transformer should be larger than the maximum lamp starting voltage.

Note 6: The" Lamp life time" is defined as the module brightness decrease to 50% original brightness at Ta=25°C , I_L=6.0mA.

5. AC Timing

a. Timing conditions

Parameter	Symbol	Min.	Typ.	Max.	Unit.	Remark
Rising time	t_r	-	-	25	ns	Note 1
Falling time	t_f	-	-	25	ns	Note 1
High and low level pulse width	t_{CPH}	99	126	131	ns	CPH1~CPH3
CPH pulse duty	t_{CWH}	40	50	60	%	CPH1~CPH3
CPH pulse delay	t_{C12} t_{C23} t_{C31}	30	$t_{CPH}/3$	$t_{CPH}/2$	ns	CPH1~CPH3
STH setup time	t_{SUH}	20	-	-	ns	STHR,STHL
STH hold time	t_{HDH}	20	-	-	Ns	STHR,STHL
STH pulse width	t_{STH}	-	1	-	t_{CPH}	STHR,STHL
STH period	t_H	61.5	63.5	65.5	μs	STHR,STHL
OEH pulse width	t_{OEH}	-	1.22	-	μs	OEH
Sample and hold disable	t_{DIS1}	-	8.28	-	μs	
OEV pulse width	t_{OEV}	-	5.40	-	μs	OEV
CKV pulse width	t_{CKV}	-	4.18	-	μs	CKV
Clean enable time	t_{DIS2}	-	3.74	-	μs	
Horizontal display start	t_{SH}	-	0	-	$T_{CPH}/3$	
Horizontal display timing range	t_{DH}	-	1200	-	$T_{CPH}/3$	
STV setup time	t_{SUV}	400	-	-	ns	STVL,STVR
STV hold time	t_{HDV}	400	-	-	ns	STVL,STVR
STV pulse width	t_{STV}	-	-	1	t_H	STVL,STVR
Horizontal lines per field	t_V	256	262	268	t_H	Note 2
Vertical display start	t_{SV}		3	-	t_H	
Vertical display timing range	t_{DV}		234	-	t_H	
VCOM rising time	t_{rCOM}		-	5	μs	
VCOM falling time	t_{fCOM}		-	5	μs	
VCOM delay time	t_{DCOM}		-	3	μs	
RGB delay time	t_{DRGB}		-	1	μs	

Note 1: For all of the logic signals.

Note 2: Please don't use odd horizontal lines to drive LCD panel for both odd and even field simultaneously.

b. Timing diagram

Please refer to the attached drawing, from Fig.2 to Fig.6.

C. Optical specification (Note 1)

Item		Symb	Condition	Min.	Typ.	Max.	Unit	Remark
Response time	Rise	Tr	$\theta = 0^\circ$	-	15	50	ms	Note 1,2,4
	Fall	Tf		-	20	60	ms	
Contrast ratio		CR	At optimized Viewing angle	200	300	-		Note 3,4
Viewing angle	Top	$CR \geq 10$		30	45	-	deg.	Note 4,6
	Bottom			50	60	-		
	Left			50	60	-		
	Right			50	60	-		
	Top	$CR \geq 5$		40	50	-	deg.	Note 4,5
	Bottom			60	70	-		
	Left			60	70	-		
	Right			60	70	-		
Brightness		Y_L	$I_L=6.0mA, 25^\circ C$	500	550	-	nit	Note 6
Uniformity			$\theta = 0^\circ$			1.3		Note 7
White chromaticity		X	$\theta = 0^\circ$	0.26	0.31	0.36		Note 6
		Y	$\theta = 0^\circ$	0.28	0.33	0.38		

Note 1 : Ambient temperature =25°C. And lamp current $I_L = 6.0$ mArms. To be measured in the dark room and to be measured on the center area of panel with a viewing cone of 1° by Topcon luminance meter BM-5, after 10 minutes operation.

Note 2. Definition of response time:

The output signals of photo detector are measured when the input signals are changed from “black” to “white”(falling time) and from “white” to “black”(rising time), respectively. The response time is defined as the time interval between the 10% and 90% of amplitudes. Refer to figure as below.

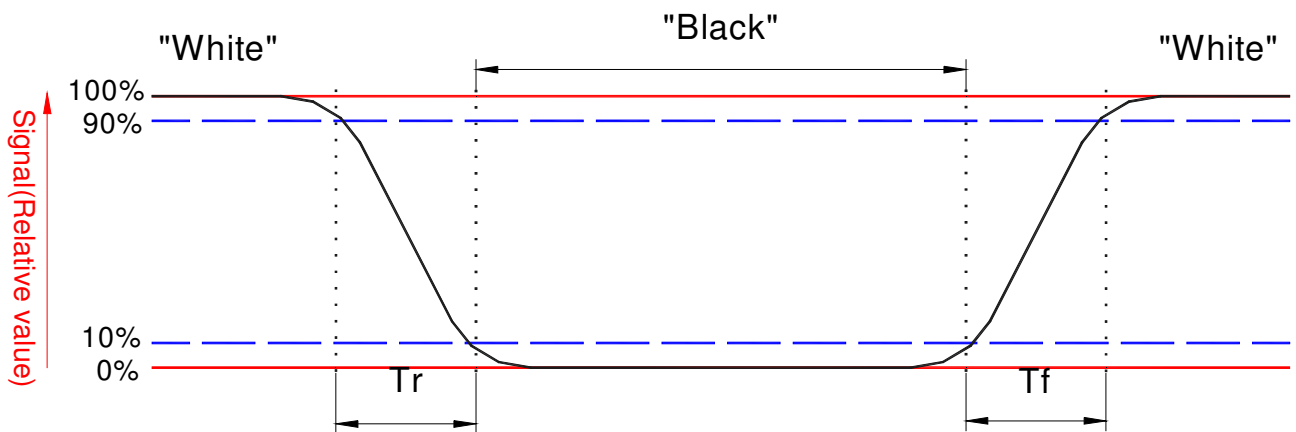

Note 3. Definition of contrast ratio:

Contrast ratio is calculated with the following formula.

$$\text{Contrast ratio (CR)} = \frac{\text{Photo detector output when LCD is at "White" state}}{\text{Photo detector output when LCD is at "Black" state}}$$

Note 4. White $V_i = V_{i50} + 1.5V$

Black $V_i = V_{i50} \pm 2.0V$

“±” means that the analog input signal swings in phase with V_{COM} signal.

“ \mp ” means that the analog input signal swings out of phase with V_{COM} signal.

V_{i50} : The analog input voltage when transmission is 50%

The 100% transmission is defined as the transmission of LCD panel when all the input terminals of module are electrically opened.

Note 5. Definition of viewing angle, refer to figure as below.

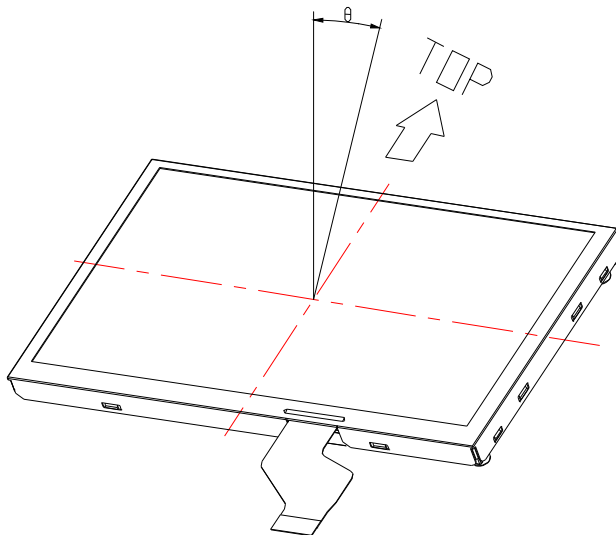

Note 6. Measured at the center area of the panel when all the input terminals of LCD panel are electrically opened.

Note 7. Uniformity value = (max. brightness)/(min. brightness), 9 points.

D. Reliability test items(Note 2):

No.	Test items	Conditions	Remark
1	High temperature storage	Ta= 95°C 240Hrs	
2	Low temperature storage	Ta= -40°C 240Hrs	
3	High temperature operation	Ta= 85°C 240Hrs	
4	Low temperature operation	Ta= -30°C 240Hrs	
5	High temperature and high humidity	Ta= 60°C, 90% RH 240Hrs	Operation
6	Heat shock	-40°C~85°C/240 cycles 1Hrs/cycle	Non-operatio
7	Electrostatic discharge	±200V,200pF(0Ω), once for each terminal	Non-operatio n
8	Vibration	Frequency range : 8~33.3Hz Stoke : 1.3mm Sweep : 2.9G,33.3~400Hz 2 hours for each direction of X, Z 4 hours for direction of Y	JIS D1601, A-10 condition A Note3
9	Mechanical shock	100G, 6ms, ±X,±Y,±Z 3 times for each direction	JIS C7021, A-7 condition C
10	Vibration (with carton)	Random vibration: 0.015G ² /Hz from 5~200Hz -6dB/octave from 200~500Hz	IEC 68-34
11	Drop (with carton)	Height: 60cm 1 corner, 3 edges, 6 surfaces	JIS Z0202

Note 1: Ta: Ambient temperature.

Note 2: In the standard conditions, there is not display function NG issue occurred. All the cosmetic specification is judged before the reliability stress.

Note 3: Cycle time for vibration is 15 minutes.

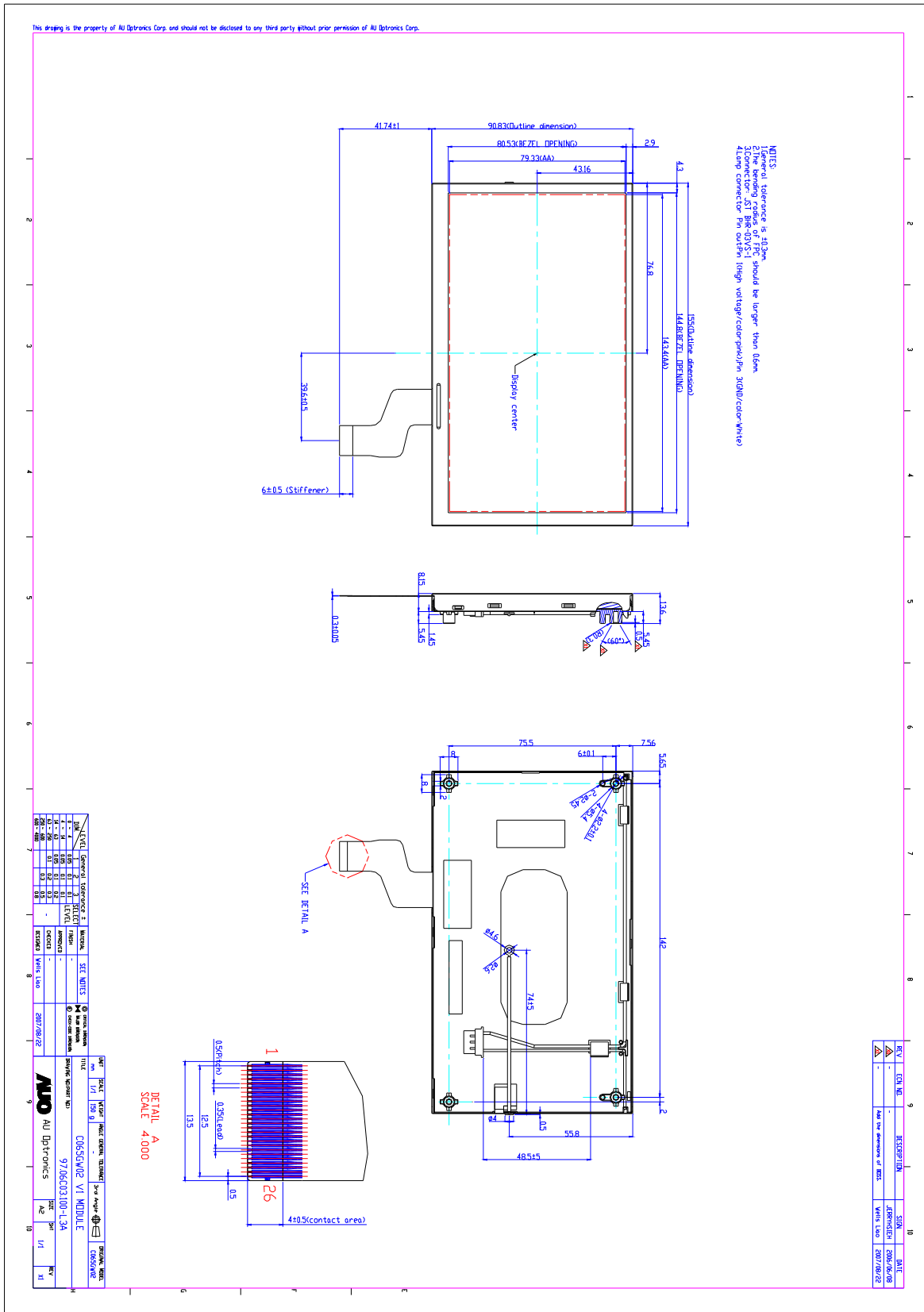

Fig.1 Outline dimension of TFT-LCD module

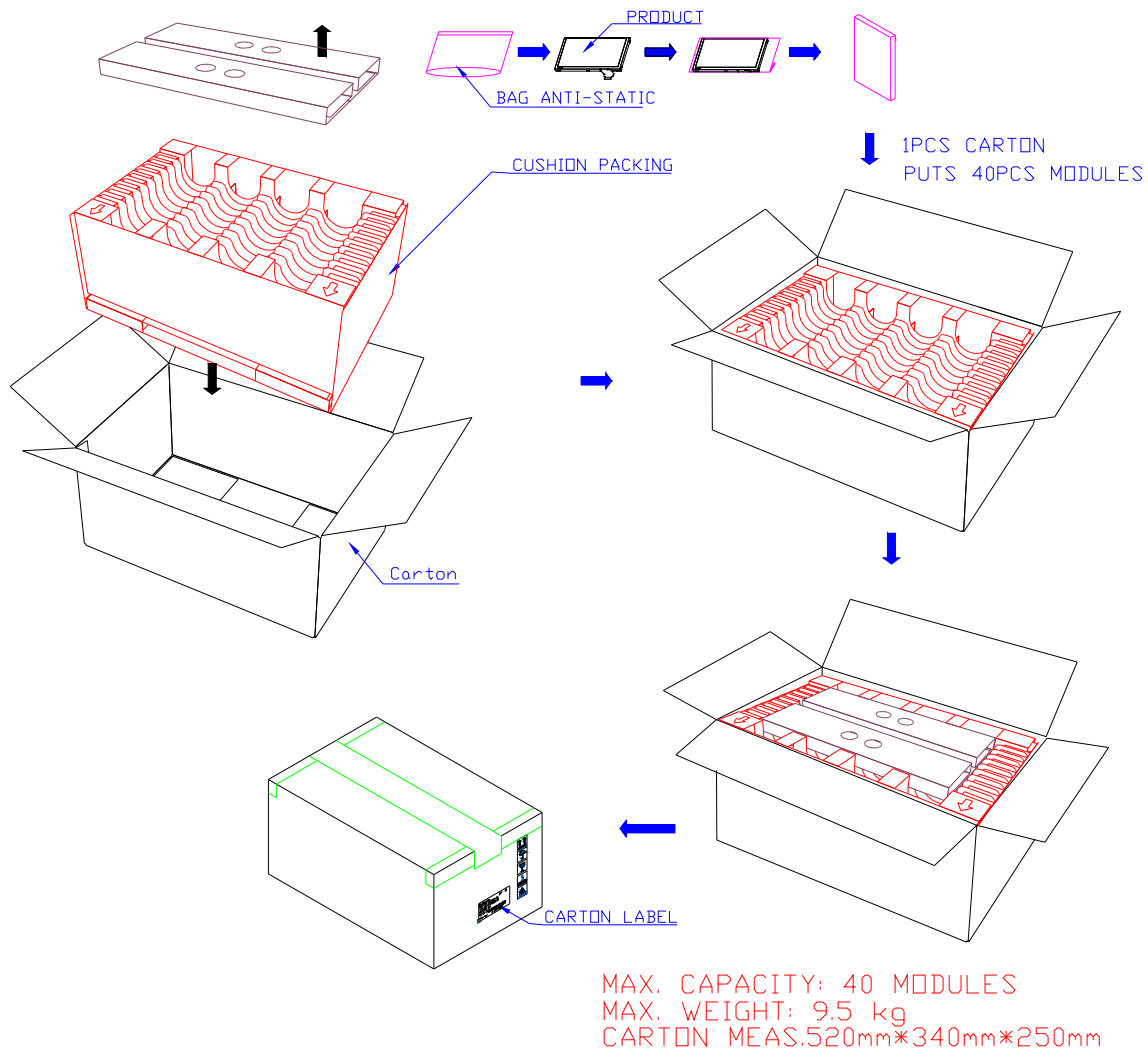

Fig. 2 Package drawing of TFT-LCD module

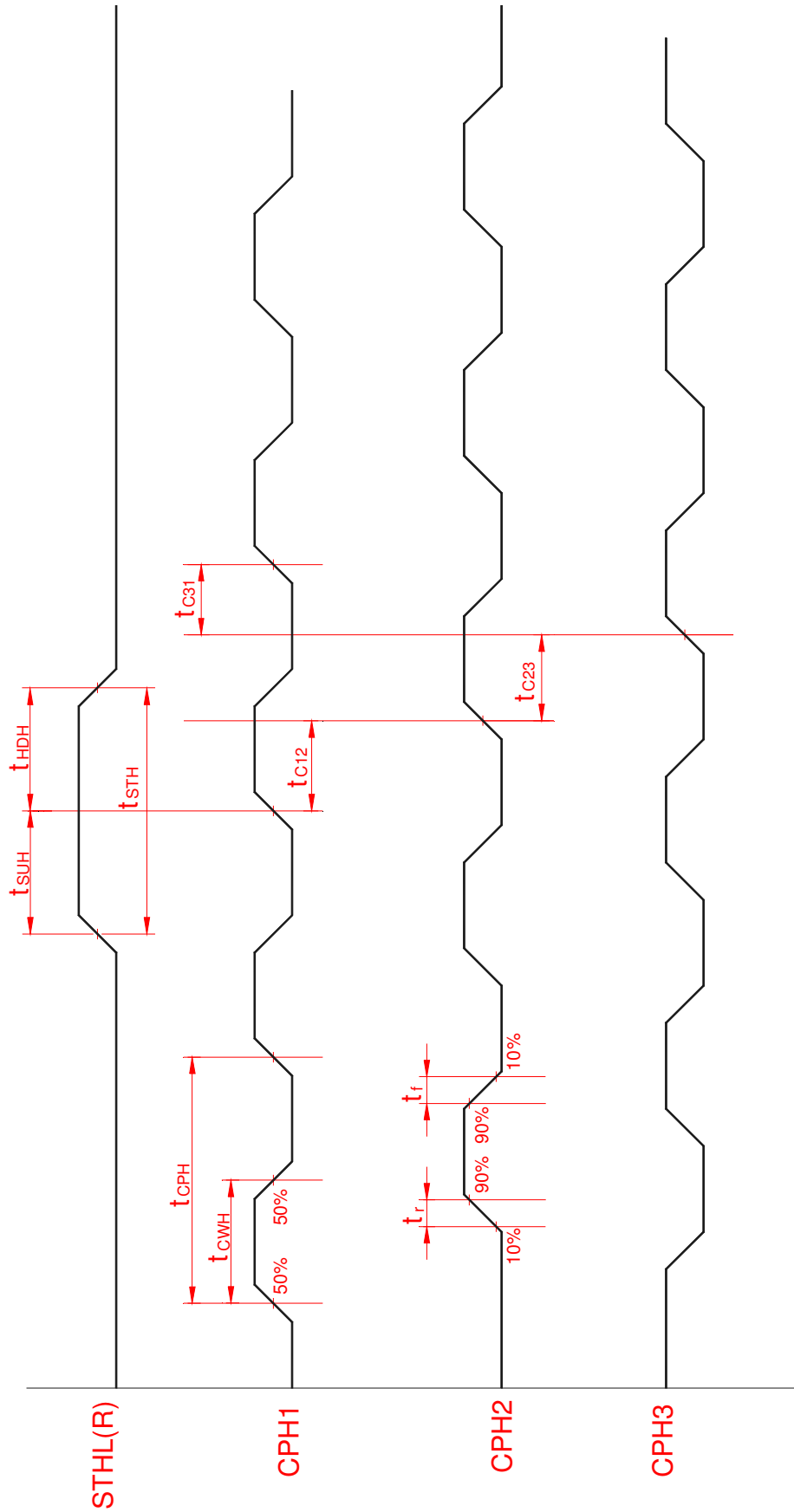

Fig.3 Sampling clock timing

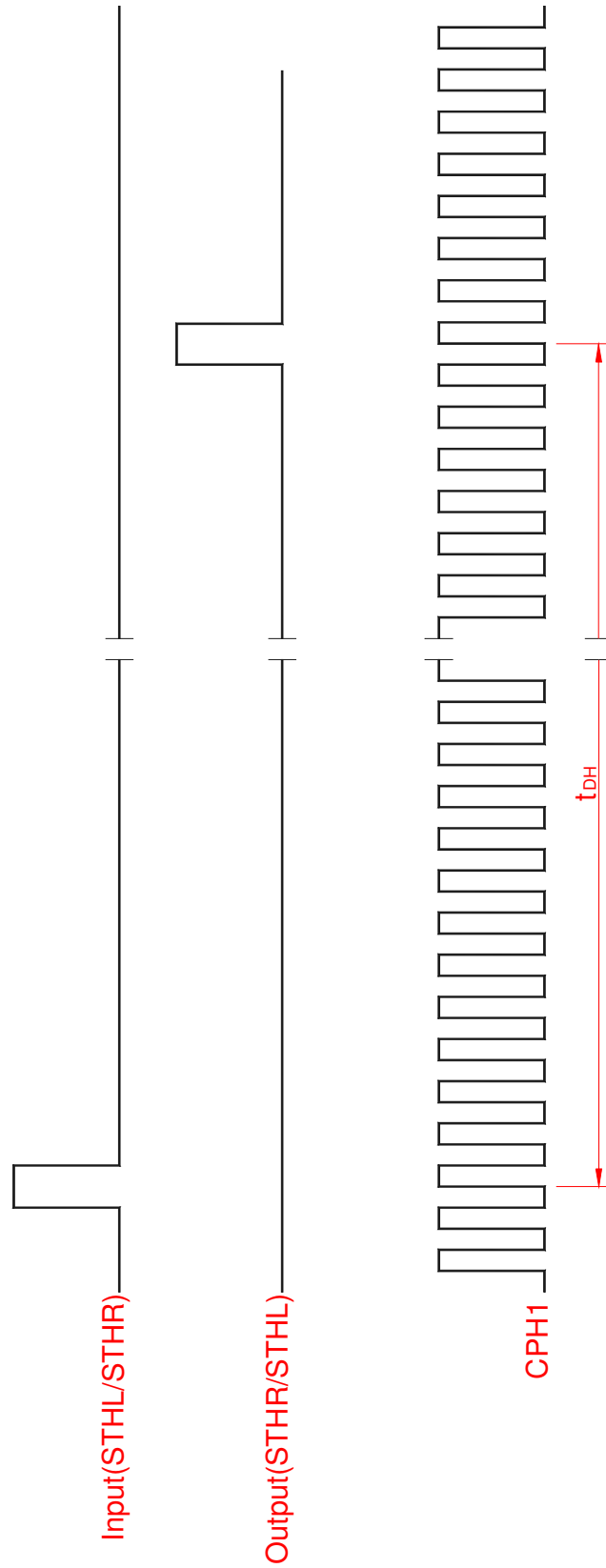

Fig.4 Horizontal display timing range

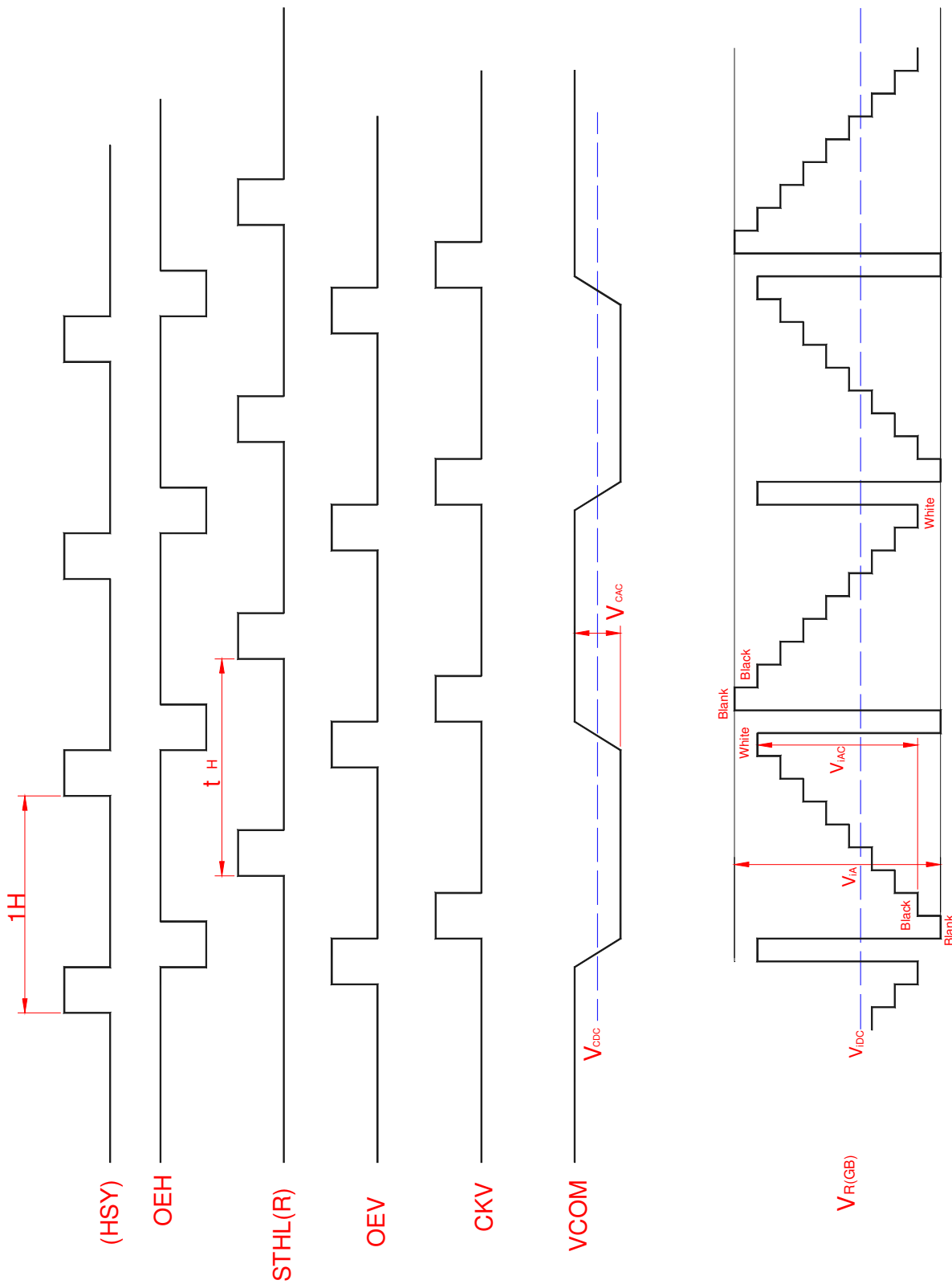
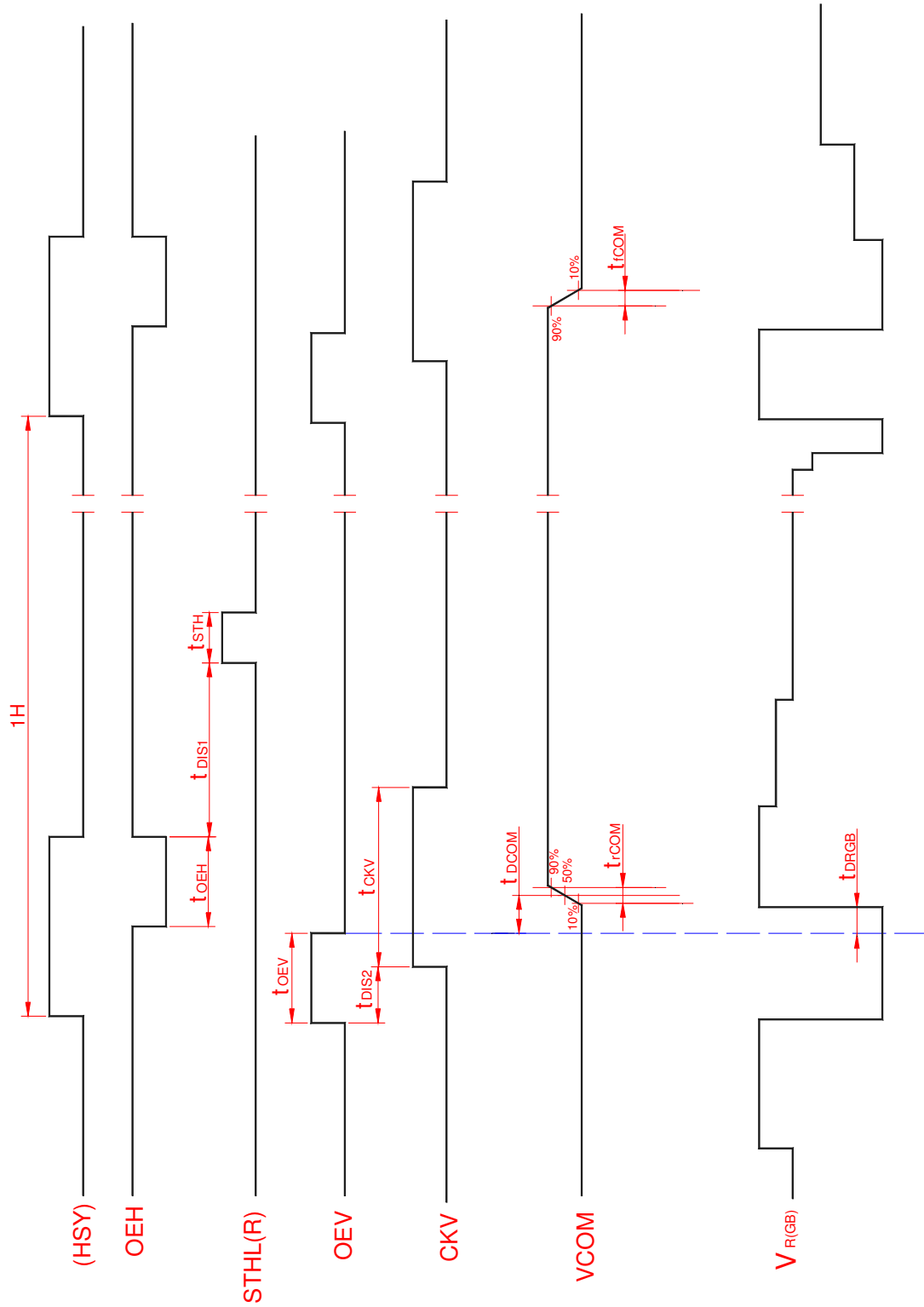

Fig.5-(a) Horizontal timing



Note: The falling edge of OEV should be synchronized with the falling edge of OEH

Fig.5-(b) Detail horizontal timing

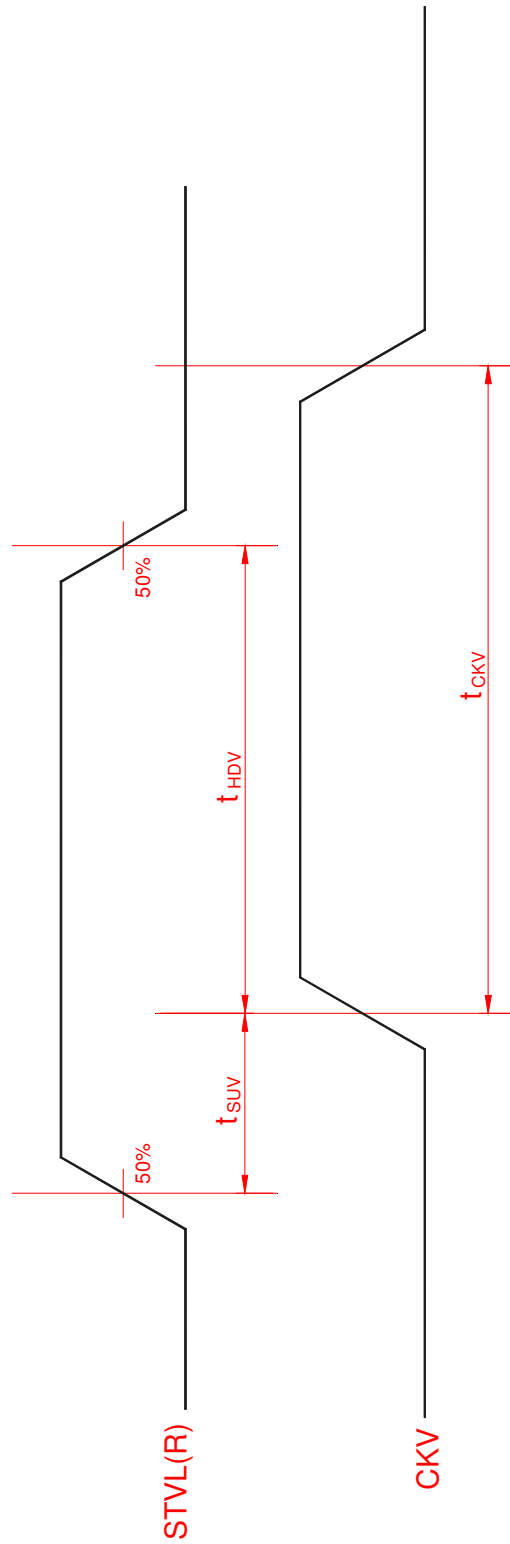

Fig.6 Vertical shift clock timing

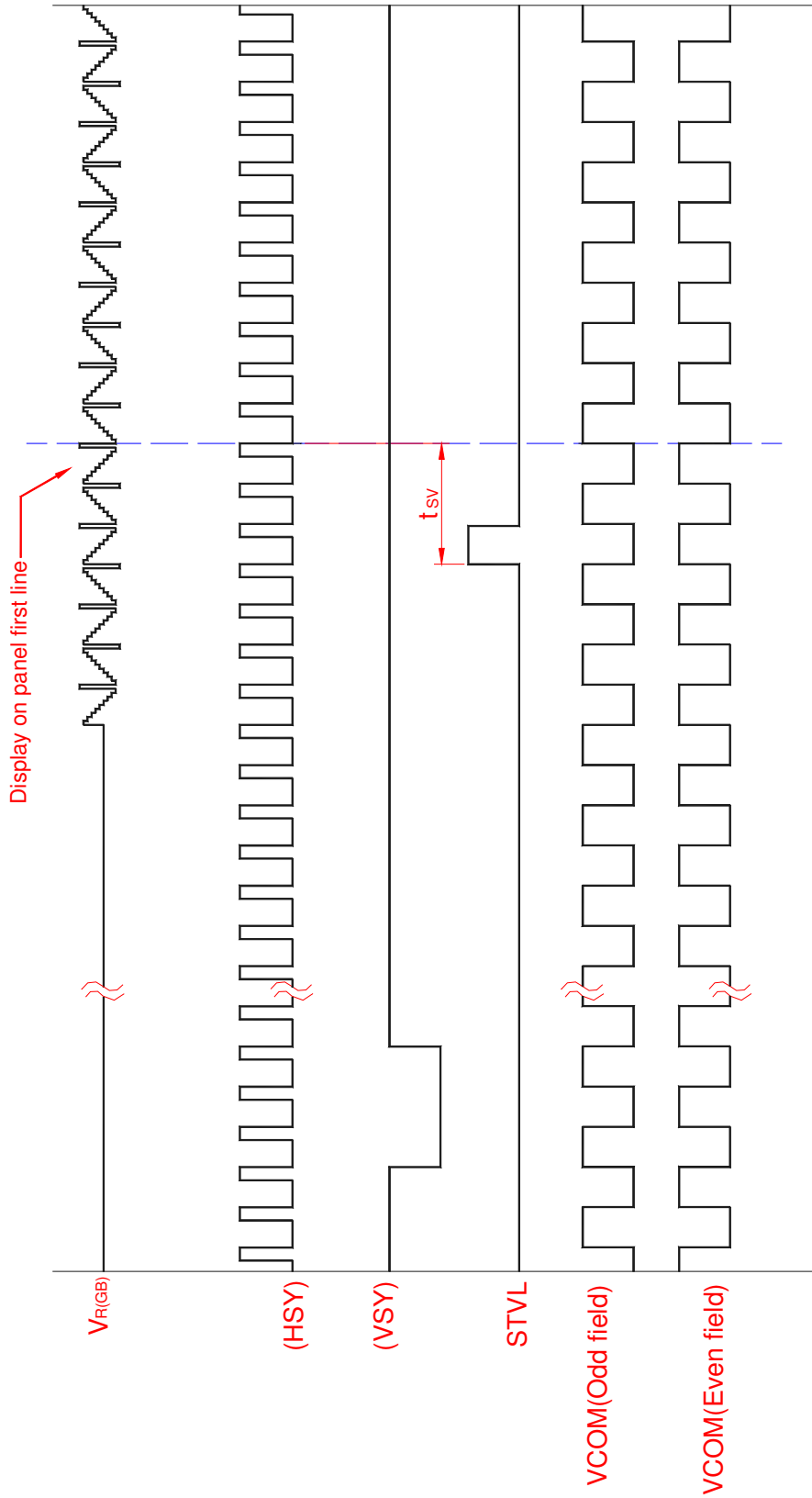

Fig.7-(a) Vertical timing (From up to down)

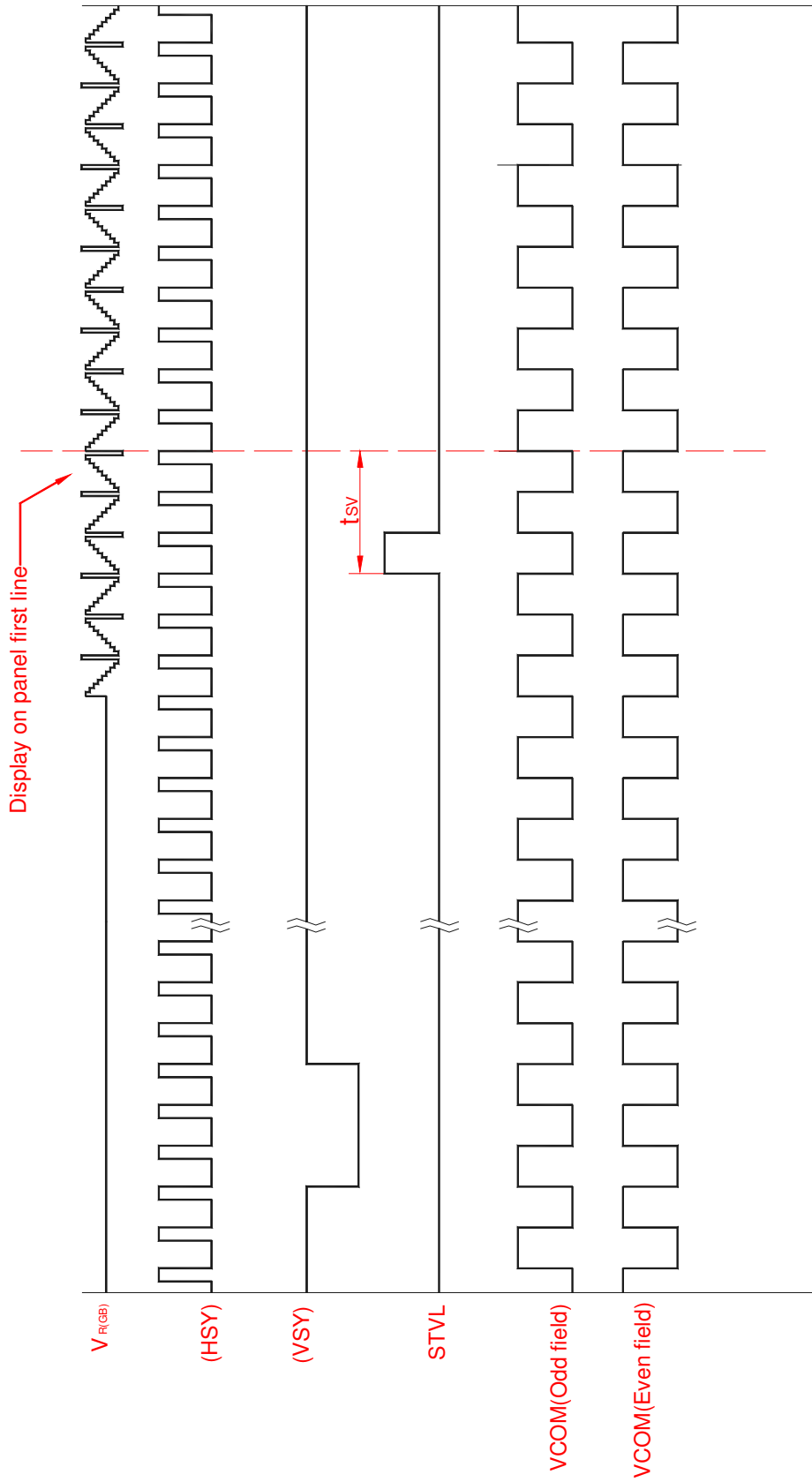
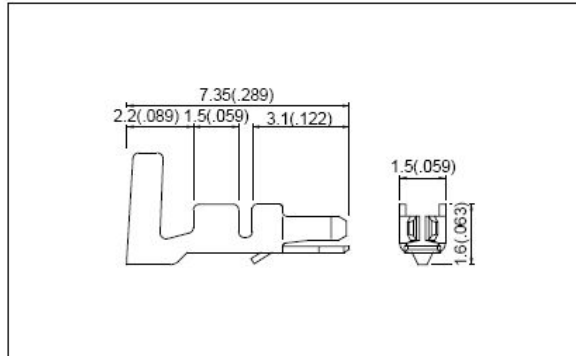

Fig.7-(b) Horizontal timing (From down to up)

Appendix 1: CCFL connector – JST BHR(03)VS-1

Contact



Model No.	Applicable wire			Q'ty / reel
	mm ²	AWG #	Insulation O.D. min(in.)	
SBH-001T-P0.5	0.08 to 0.33	28 to 22	.16 to 24(.063 to .094)	4,000

Material and Finish

Phosphor bronze, tin-plated

Note: Wire conductors should be tin-plated annealed copper strands.

Housing

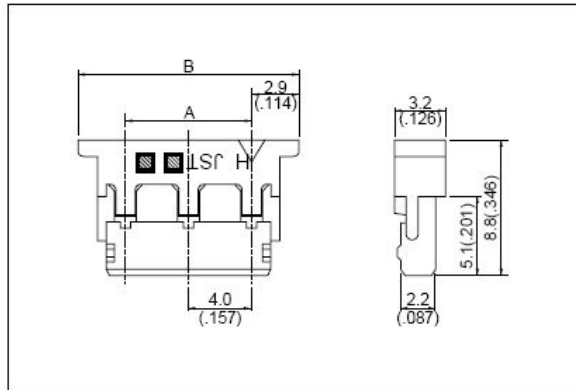

Circuits	Pitch mm(in.)	Model No.	Dimensions mm(in.)		Q'ty / bag
			A	B	
2	4(.157)	BHR-02VS-1	4.0(.157)	9.8(.386)	1,000
	8(.315)	BHR-03VS-1	8.0(.315)	13.8(.543)	1,000
	12(.472)	BHR-04VS-1	12.0(.472)	17.8(.701)	1,000
3	4(.157)	BHR-03VS-1	8.0(.315)	13.8(.543)	1,000
4	4(.157)	BHR-04VS-1	12.0(.472)	17.8(.701)	1,000

Material

Nylon 66, UL94V-0, natural (white)