



**Version: 0.2**  
**Total Pages: 26**  
**Date: 2004/03/15**

## Product Functional Specification

8.4 inch SVGA Color TFT LCD Module  
Model Name: G084SN05 V.2

Preliminary Specification  
 Final Specification

Note: This Specification is subject to change without notice.



## **I. Contents**

- 1.0 Handling Precautions**
- 2.0 General Description**
  - 2.1 Characteristics**
  - 2.2 Functional Block Diagram**
- 3.0 Absolute Maximum Ratings**
- 4.0 Optical Characteristics**
- 5.0 Signal Interface**
  - 5.1 Connectors**
  - 5.2 Signal Pin**
  - 5.3 Signal Description**
  - 5.4 Signal Electrical Characteristics**
  - 5.5 Signal for Lamp Connector**
- 6.0 Pixel Format Image**
  - 6.1 Scanning Direction**
- 7.0 Parameter Guideline for CCFL Inverter**
- 8.0 Interface Timings**
  - 8.1 Timing Characteristics**
  - 8.2 Timing Definition**
- 9.0 Power Consumption**
- 10.0 Power On/Off Sequence**
- 11.0 Mechanical Characteristics**



## II. Record of Revision

Version and Date	Page	Old Description	New Description	Remark
0 2003/11/27	All	First Draft	First Draft	
0.1 2004/2/10	6		Add functional block diagram	
	16		Update CCFL spec.	
	24		Update outline drawing	
0.2 2004/3/15	6	Power Consumption: 5.3W Weight: 275±10 Physical size: 203x142.5x11.4	Power Consumption: 7.5W Weight: 310±10 Physical size: 203x142.5x12.5	
	11		Connector 2 Type/Part Number Correction	
	14	Lamp connector Pin 1: L, Pin 3: H	Lamp connector Pin 1: H, Pin 3: L	
	23		VDD, PDD & IDD updated	
	25,26		Drawing updated	



## 1.0 Handling Precautions

- 1) Since front polarizer is easily damaged, pay attention not to scratch it.
- 2) Be sure to turn off power supply when inserting or disconnection from input connector.
- 3) Wipe off water drop immediately. Long contact with water may cause discoloration or spots.
- 4) When the panel surface is soiled, wipe it with absorbent cotton or other soft cloth.
- 5) Since the panel is made of glass, it may break or crack if dropped or bumped on hard surface.
- 6) Since CMOS LSI is used in this module, take care of static electricity and insure human earth when handling.
- 7) Do not open nor modify the module Assembly.
- 8) Do not press the reflector sheet at the back of the module to any directions.
- 9) In case if a module has to be put back into the packing container slot after once it was taken out from the container, do not press the center of the CCFL Reflector edge. Instead, press at the far ends of the CCFL Reflector edge softly. Otherwise the TFT module may be damaged.
- 10) At the insertion or removal of the Signal Interface Connector, be sure not to rotate nor tilt the interface Connector of the TFT module.
- 11) After installation of the TFT module into an enclosure, do not twist nor bend the TFT module even momentary. At designing the enclosure, it should be taken into consideration that no bending/twisting forces are applied to the TFT module from outside. Otherwise the TFT module may be damaged.
- 12) Cold cathode fluorescent lamp in LCD contains a small amount of mercury. Please follow local ordinances or regulations for disposal.
- 13) Small amount of materials having no flammability grade is used in the LCD module should be supplied by power complied with requirements of Limited Power Source, or be applied exemption.
- 14) The LCD module is designed so that the CCFL in it is supplied by Limited Current Circuit. Do not connect the CCFL in Hazardous Voltage Circuit.



## 2.0 General Description

This specification applies to the 8.4 inch color TFT LCD module G084SN05 V.2.

This module is designed for display units for Industrial Applications.

The screen format is intended to support the SVGA 800(H) x 600(V) and VGA 640(H) x 480(V) (through internal video scaling) screen and 262k colors (6bits RGB).

Input signals can be either digital 6bit RGB or analog RGB. Reverse scan function can also be activated through the digital input signal.

The module does not contain an inverter card for backlight.

## 2.1 Display Characteristics

The following items are characteristics summary on the table under 25°C condition :

Items	Unit	Specifications
Screen Diagonal	[mm]	213.4 ( 8.4")
Active Area	[mm]	170.4(H) x 127.8(V)
Pixel H x V		800(x3) x 600
Pixel Pitch	[mm]	0.213(H) x 0.213(V)
Pixel Arrangement		R.G.B. Vertical Stripe
Display Mode		Normally White
Typical White Luminance (ICFL=6 mA)	[cd/m <sup>2</sup> ]	350 Typ. (center)
Contrast Ratio		350 : 1 Typ.
Optical Rise Time/Fall Time	[msec]	10/25 Typ.
Nominal Input Voltage VDD	[Volt]	+3.3 Typ.
Typical Power Consumption (VDD line + VCFL line)	[Watt]	7.5 Typ
Weight	[Grams]	310 ±10
Physical Size	[mm]	203(W) x 142.5(H) x 12.5(D)
Electrical Interface		6bit RGB / analog RGB
Support Color		Native 262K colors (RGB 6-bit driver)
Temperature Range		
Operating	[°C]	0 to +50
Storage(Shipping)	[°C]	-20 to +60



## 2.2 Functional Block Diagram

The following diagram shows the functional block of the 8.4 inches Color TFT LCD Module :

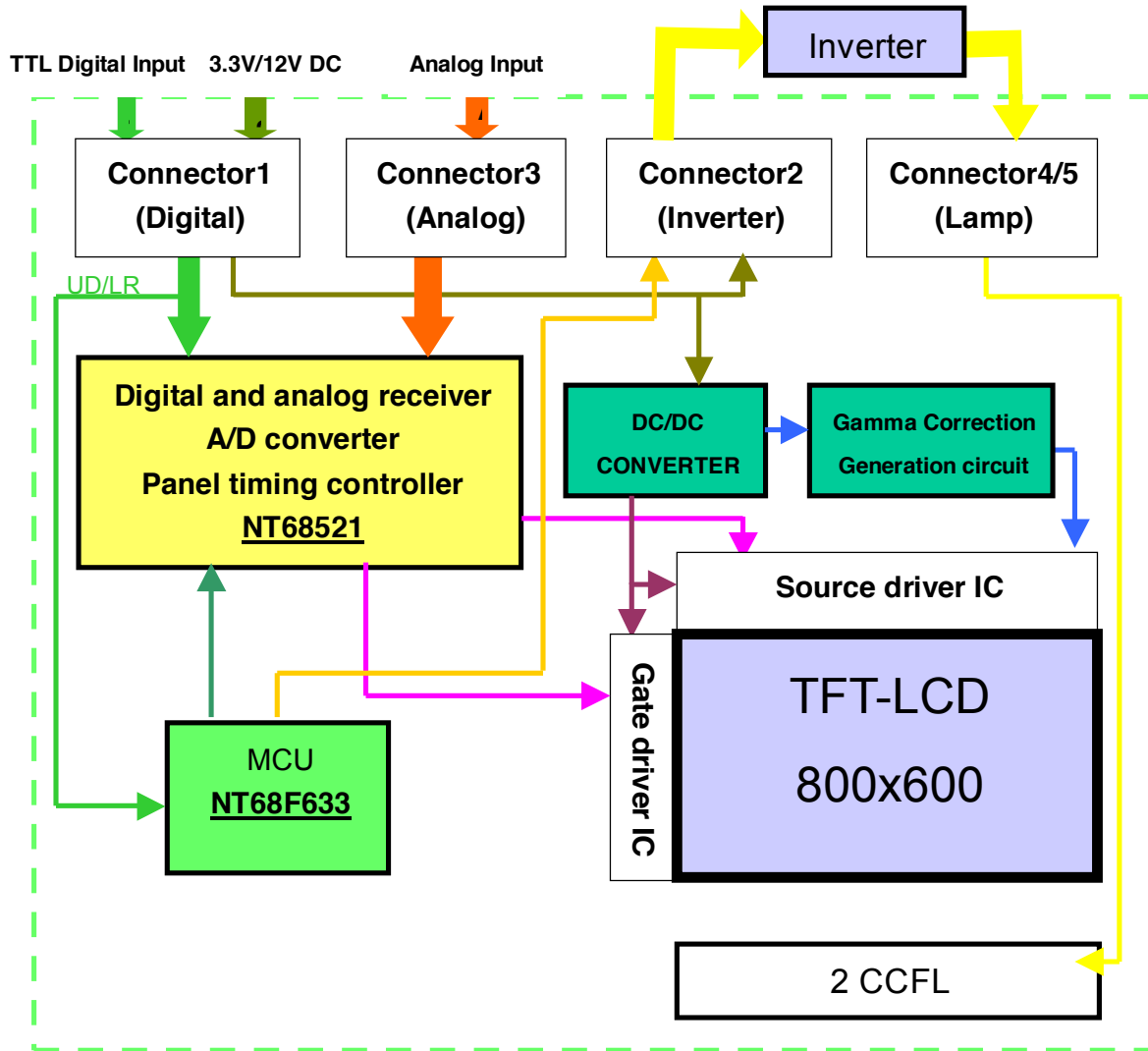



### 3.0 Absolute Maximum Ratings

Absolute maximum ratings of the module is as follows :

Item	Symbol	Min	Max	Unit	Conditions
Logic/LCD Drive Voltage	VDD	-0.3	+6.0	[Volt]	
Input Voltage of Signal	Vin	-0.3	VDD+0.3	[Volt]	
Operating Temperature	TOP	0	+50	[°C]	Note1
Operating Humidity	HOP	8	95	[%RH]	Note1
Storage Temperature	TST	-20	+60	[°C]	Note1
Storage Humidity	HST	5	95	[%RH]	Note1

**Note1** : Maximum Wet-Bulb should be 39°C and no condensation.

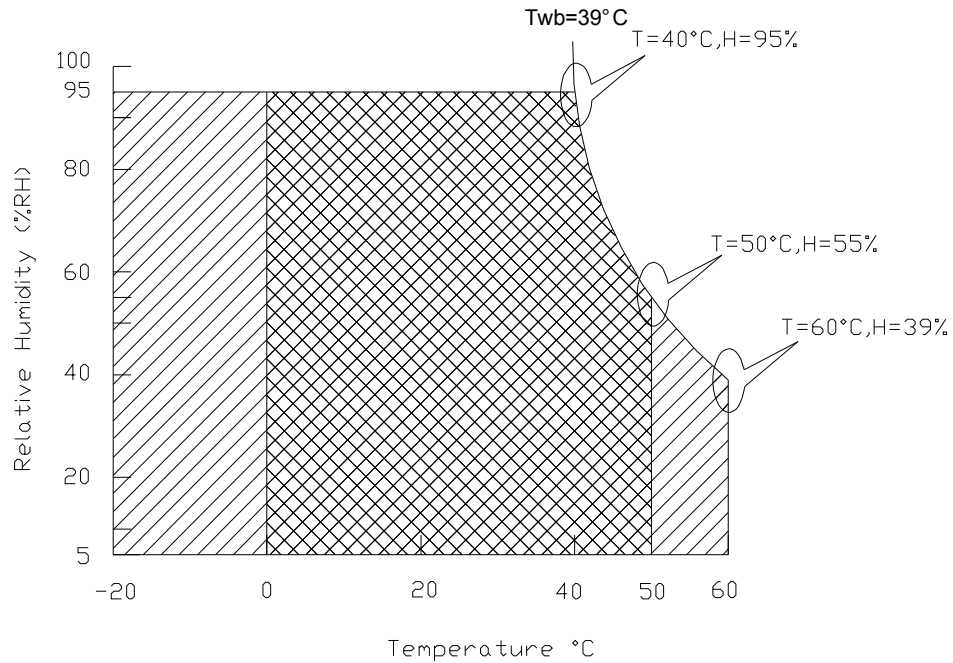

**Operating Range**



**Storage Range**

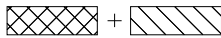



## 4.0 Optical Characteristics

The optical characteristics are measured under stable conditions as follows under 25°C condition :

Item	Unit	Conditions	Min.	Typ.	Max.
Viewing Angle	[degree]	Horizontal (Right)	—	60	—
	[degree]	K $\geq$ 10 (Left)	—	60	—
K : Contrast ratio	[degree]	Vertical (Upper)	—	60	—
	[degree]	K $\geq$ 10 (Lower)	—	40	—
White Uniformity		9 Points	—	—	1.6
Contrast ratio		$\theta = 0^\circ$	250	350	—
Response Time (Room Temp)	[msec]	Rising	—	10	20
	[msec]	Falling	—	25	30
Color Chromaticity Coordinates(CIE)		Red x		TBD	
		Red y		TBD	
		Green x		TBD	
		Green y		TBD	
		Blue x		TBD	
		Blue y		TBD	
		White x		TBD	
		White y		TBD	
White Luminance (ICFL 6mA)	[cd/m <sup>2</sup> ]	$\theta = 0^\circ$	280	350	—





**Note 1: Definition of white uniformity:**

White uniformity is calculated with the following formula.  
Luminance are measured at the following nine points (1~9).

$$\delta_w = \frac{\text{Maximum Brightness of nine points}}{\text{Minimum Brightness of nine points}}$$

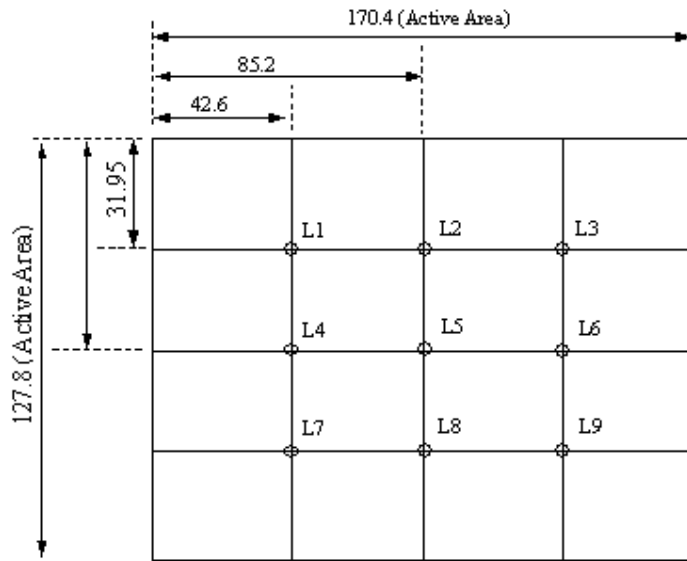

Unit: mm



## 5.0 Signal Interface

### 5.1 Connectors

Physical interface is described as for the connector on module.

These connectors are capable of accommodating the following signals and will be following components.

Connector Name	Connector 1	Connector 2	Connector 3	Connector 4/5
Description	Digital Signal	Lamp Control	Analog Signal	Lamp Power
Manufacturer	Kyocera Elco	JST	HIROSE	JST
Type / Part Number	04 6274 036 000 800	S5B-ZR-SM3A-TF	DF13B-9P-1.25	BHR-03VS-1
Mating Connector				B-BHS-1-TB

### 5.2 Signal Pin

#### 5.2.1 Digital Input Signal (Connector 1)

Pin No.	Signal Name	Pin No.	Signal Name
1	GND	2	DCLK_IN
3	DE_IN	4	HSYNC_IN
5	VSYNC_IN	6	GND
7	RIN0	8	RIN1
9	RIN2	10	RIN3
11	RIN4	12	RIN5
13	GIN0	14	GIN1
15	GIN2	16	GIN3
17	GIN4	18	GIN5
19	BIN0	20	BIN1
21	BIN2	22	BIN3
23	BIN4	24	BIN5
25	GND	26	REV
27	VDD	28	VDD
29	VDD	30	DIMMER
31	GND	32	GND
33	GND	34	VBL
35	VBL	36	VBL



Note 1: Selection of scanning mode (please refer to the following table)

Setting of scancontrol input	Input Signal	Scanning direction
REV (No.26 pin)	Lo	From up to down, and from left to right
REV (No.26 pin)	Hi	From down to up, and from right to left

### 5.2.2 Analog Input Signal (Connector 3)

Pin No.	Signal Name	Pin No.	Signal Name
1	VGA_HSYNC	2	VGA_VSYNC
3	AGNF	4	RED
5	RED_GND	6	GREEN_GND
7	GREEN	8	BLUE_GND
9	BLUE		

### 5.2.3 Inverter Output Signal (Connector 2)

Pin No.	Signal Name	Pin No.	Signal Name
1	VBL	2	GND
3	DIMMER	4	VBLCTRL
5	GND		

## 5.3 Signal Description

### 5.3.1 Digital Input Pin Description (Connector 1)

Signal Name	Description
VSS	GND
REV	Trigger of reverse scan function
VDD	+3.3V Power Supply
GND	Ground
VBL	Inverter Power Supply
DIMMER	Brightness of Backlight Control Signal



Signal Name	Description	
RIN0	Red Data 5 (MSB)	Red-pixel Data Each red pixel's brightness data consists of 6 bits pixel data.
RIN1	Red Data 4	
RIN2	Red Data 3	
RIN3	Red Data 2	
RIN4	Red Data 1	
RIN5	Red Data 0 (LSB) Red-pixel Data	
GIN0	Green Data 5 (MSB)	Green-pixel Data Each green pixel's brightness data consists of 6 bits pixel data.
GIN1	Green Data 4	
GIN2	Green Data 3	
GIN3	Green Data 2	
GIN4	Green Data 1	
GIN5	Green Data 0 (LSB) Green-pixel Data	
BIN0	Blue Data 5 (MSB)	Blue-pixel Data Each blue pixel's brightness data consists of 6 bits pixel data.
BIN1	Blue Data 4	
BIN2	Blue Data 3	
BIN3	Blue Data 2	
BIN4	Blue Data 1	
BIN5	Blue Data 0 (LSB) Blue-pixel Data	
CLK	Data Clock	The typical frequency is 40MHz. The signal is used to strobe the pixel data and DE signals. All pixel data shall be valid at the falling edge when the DE signal is high.
DE	Display Timing	This signal is strobed at the falling edge of CLK. When the signal is high, the pixel data shall be valid to be displayed.
VSYNC	Vertical Sync	The signal is synchronized to CLK.
HSYNC	Horizontal Sync	The signal is synchronized to CLK.

**Note** : Output signals from any system shall be low or Hi-Z state when VDD is off.



### 5.3.2 Analog Input Pin Description (Connector 3)

Signal Name	Description
VGA_HSYNC	The signal is synchronized to CLK
VGA_VSYNC	The signal is synchronized to CLK.
RED	Analog R Signal Input
GREEN	Analog G Signal Input
BLUE	Analog B Signal Input
RED_GND	A_GND
GREEN_GND	
BLUE_GND	

### 5.3.3 Inverter Control Pin Description (Connector 2)

Signal Name	Description
VBL	Inverter power
GND	GND
DIMMER	Brightness of Backlight control signal
VBLCTRL	Inverter Power Control Signal

### 5.3.4 Lamp Power (Connector 4/5)

Connector: JST BHR-03VS-1, Mating connector: JST SM03(4.0)B-BHS-1-TB

Pin no.	Symbol	Function	Remark
1	H	CCFL power supply (H.V.)	Cable color: Pink
2	NC	No connection	
3	L	CCFL power supply (GND)	Cable color: White

## 5.4 Signal Electrical Characteristics

Input signals shall be low or Hi-Z state when VDD is off.

It is recommended to refer the specifications of SN75LVDS86(Texas Instruments) in detail.

Signal electrical characteristics are as follows :

Item	Symbol	Min.	Typ.	Max.	Unit
The differential level	$ V_{ID} $	0.1	-	0.6	V
The common mode input voltage	$V_{IC}$	$\frac{ V_{ID} }{2}$	-	$2.4 - \frac{ V_{ID} }{2}$	V
The input setup time	$t_{su}$	0.5	-	-	ns
The input hold time	$t_{hd}$	0.5	-	-	ns
High-level input voltage	$V_{IAP}$	2.0			V
Low-level input voltage	$V_{IAM}$			0.8	V
Clock frequency	CLK	31		68	MHz

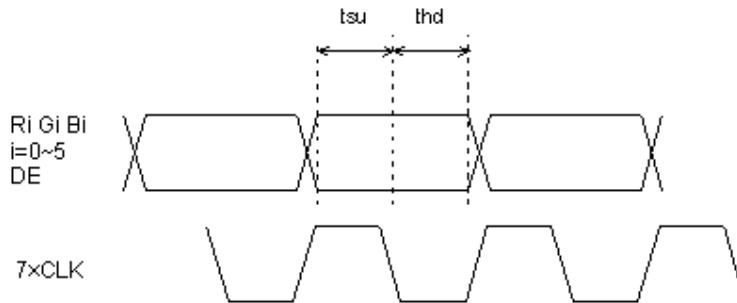
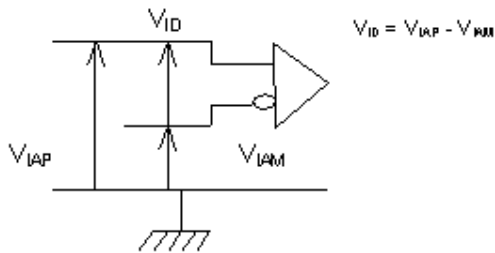



## 6.0 Pixel Format Image

Following figure shows the relationship of the input signals and LCD pixel format :

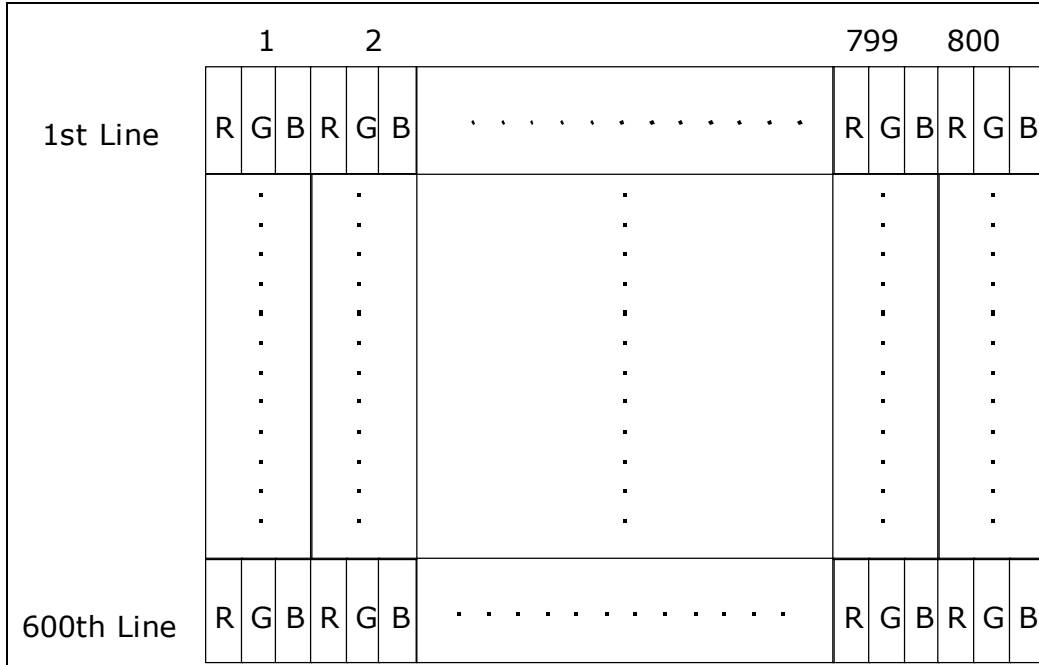

## 6.1 Scanning Direction

Following picture figures shows the image seen from the front view. The arrow indicate the direction of scan.



Fig. 1 Normal scan (REV=Lo)



Fig. 2 Reverse scan (REV=Hi)



## 7.0 Parameter guideline for CCFL inverter

Parameter	Min	Typ	Max	Units	Condition
White Luminance	280	350	-	Cd/m <sup>2</sup>	At 6mA ICFL
CCFL current (ICFL)	4	6	7	mArms	Note1
CCFL Frequency (FCFL)	40	55	80	KHz	Note4
CCFL Ignition Voltage (Vs)	-	-	500	Vrms	Note3
CCFL Voltage (Reference) (VCFL)	318.6	354	389.4	Vrms	Note1
CCFL Power consumption (PCFL)	1.91	2.12	2.33	W	Note2
Lamp Life Time	-	50,000	-	Hr	Note1, 5

**Note1** : T=25°C

**Note2** : Inverter should be designed with the characteristic of lamp. When you are designing the inverter, the output voltage of the inverter should comply with the following conditions.

- (1). The area under the positive and negative cycles of the waveform of the lamp current and lamp voltage should be area symmetric (the symmetric ratio should be larger than 90%).
- (2). There should not be any spikes in the waveform.
- (3). The waveform should be sine wave as possible.
- (4). Lamp current should not exceed the maximum value within the operating temperature (It is prohibited to over the maximum lamp current even if operated in the non-guaranteed temperature). When lamp current is over the maximum value for a long time, it may cause fire. Therefore, it is recommend that the inverter should have the current limit circuit.

**Note3** : The inverter open voltage should be designed larger than the lamp starting voltage at T=0°C, otherwise backlight may be blinking for a moment after turning on or not be able to turn on. The open voltage should be measured after ballast capacitor. If an inverter has shutdown function it should keep its open voltage for longer than 1 second even if lamp connector is open.

**Note4** : Lamp frequency may produce interference with horizontal synchronous frequency and this may cause line flow on the display. Therefore lamp frequency shall be detached from the horizontal synchronous frequency and its harmonics as far as possible in order to avoid interference.

**Note5** : Brightness (ICFL = 6mA) to drop to 50% of the initial value.





## 8.0 Interface Timings

Basically, interface timing should match the VESA 800x600 /60Hz (VG901101) manufacturing guide line timing. (VGA)

### 8.1 Timing Characteristics

#### 8.1.1 SVGA MODE

##### (a) DE mode

Item	Symbol	Min.	Typ.	Max.	Unit	Remark
Clock frequency	Fck	36	40	50	MHz	
Horizontal blanking	Thb1	18	256	624	Clk	
Vertical blanking	Tvb1	3	28	184	Th	

##### (b) HV mode

Item	Symbol	Min.	Typ.	Max.	Unit	Remark
Clock frequency	Fck	36	40	50	MHz	
Hsync period	Th	1018	1056	1424	Clk	
Hsync pulse width	Thw	2	128	-	Clk	
Hsync front porch	Thf	8	40		Clk	
Hsync back porch	Thb	4	88		Clk	
Hsync Active			800		Clk	
Hsync blanking	Thb1	218	256	624	Clk	
Vsync period	Tv	625	628	784	Th	
Vsync pulse width	Tvw	1	4		Th	
Vsync front porch	Tvf	0	1		Th	
Vsync blanking	Tvb1	25	28	184	Th	
Vsync Active			600		Th	
Hsync/Vsync phase shift	Tvpd	0	320		Clk	



Item	Symbol	Value	Unit	Description
Horizontal display start	The	218	Clk	After falling edge of Hsync, counting 218clk, then getting valid data from 219th clk's data.
Vertical display start	Tve	25	Th	After falling edge of Vsync, counting 25th, then getting 26th Th's data.

## 8.1.2 VGA MODE

### (a)DE mode

Item	Symbol	Min.	Typ.	Max.	Unit	Remark
Clock frequency	Fck	-	25.2	36	MHz	
Horizontal blanking	Thb1	-	160	192	Clk	
Vertical blanking	Tvb1	-	45	77	Th	

### (b)HV mode

Item	Symbol	Min.	Typ.	Max.	Unit	Remark
Clock frequency	Fck	-	25.2	36	MHz	
Hsync period	Th	680	800	832	Clk	
Hsync pulse width	Thw	-	96	120	Clk	
Hsync front porch	Thf	-	8	56	Clk	
Hsync back porch	Thb	-	40	80	Clk	
Hsync blanking	Thb1	-	160	192	Clk	
Hsync Active			640		Clk	
Vsync period	Tv	484	525	557	Th	
Vsync pulse width	Tvw	-	2	3	Th	
Vsync front porch	Tvf	-	2	-	Th	
Vsync blanking	Tvb1	-	45	77	Th	
Vsync active			480		Th	
Hsync/Vsync phase shift	Tvpd	0	320	-	Clk	



Item	Symbol	Value	Unit	Description
Horizontal display start	The	160	Clk	After falling edge of Hsync, counting 218clk, then getting valid data from 219th clk's data.
Vertical display start	Tve	45	Th	After falling edge of Vsync, counting 25th, then getting 26th Th's data.

## 8.2 Timing Definition

### 8.2.1 SVGA MODE

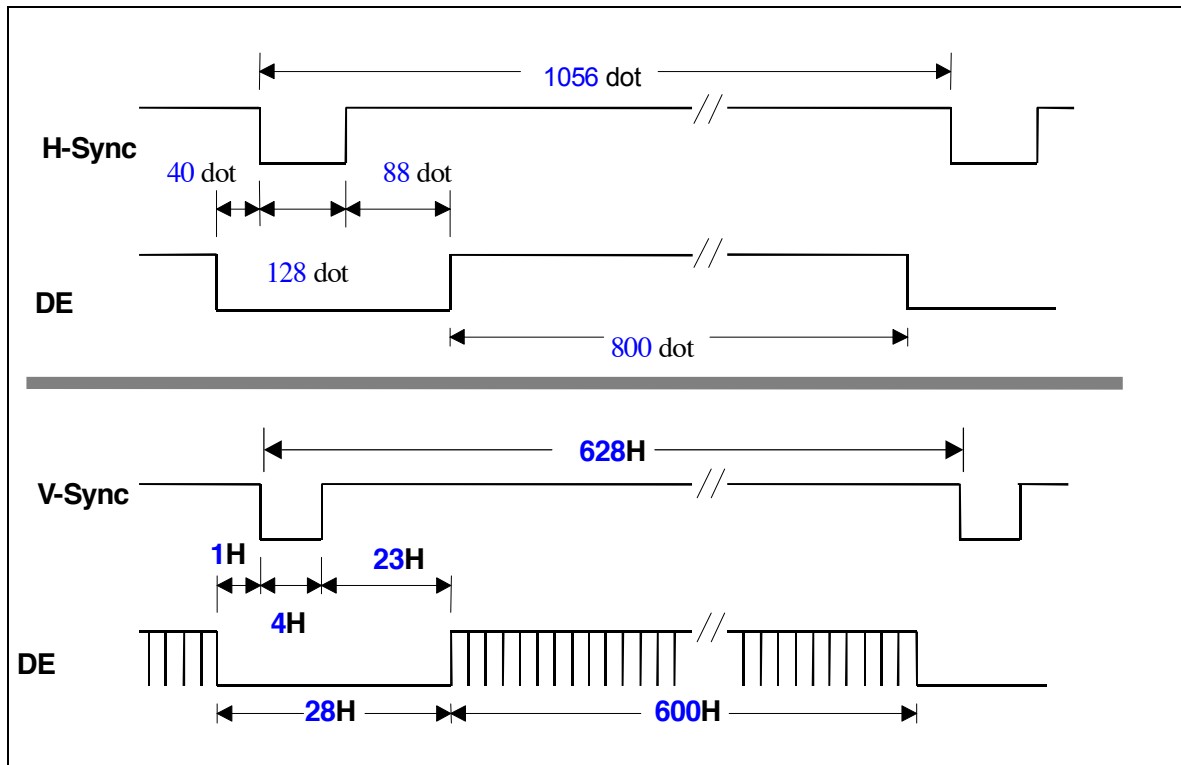

### 8.2.2 VGA MODE

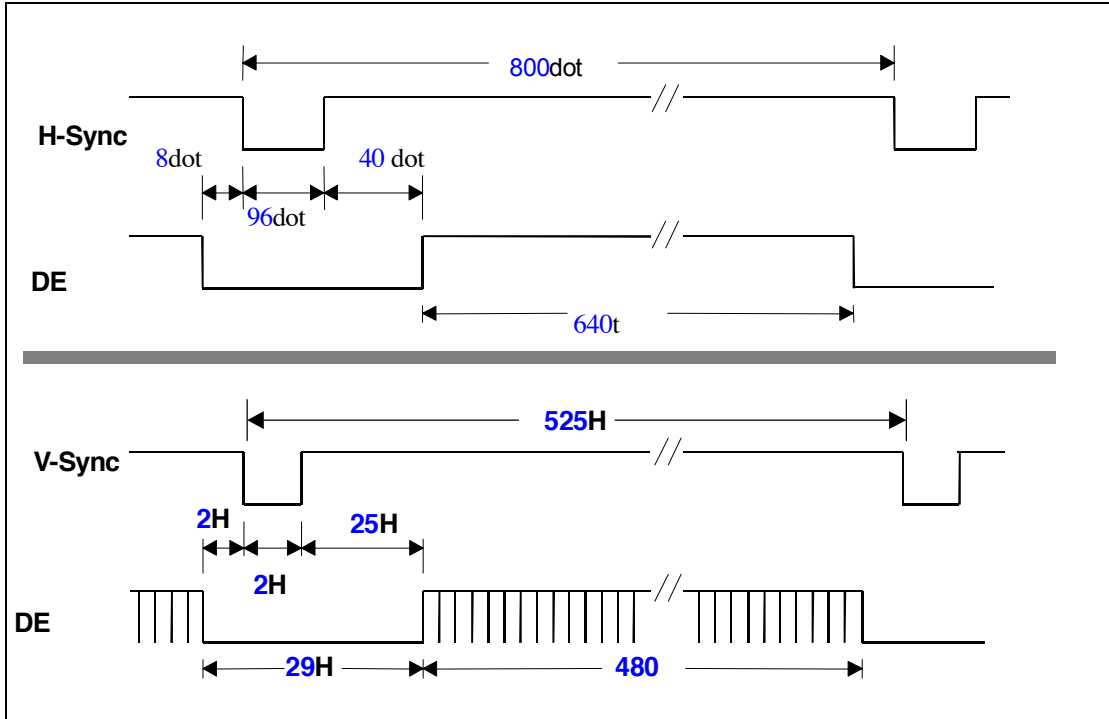

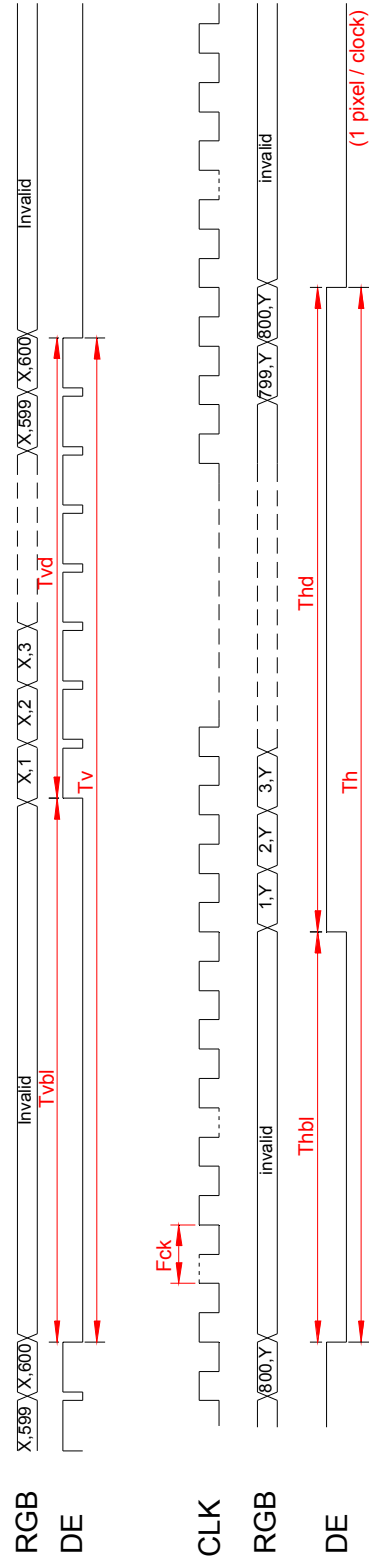

Timing Chart



## 9.0 Power Consumption

Input power specifications are as follows :

Symbol	Parameter	Min	Typ.	Max	Units	Condition
VDD	Logic/LCD Drive Voltage	3.0	3.3	3.6	V	
PDD	VDD Power	-	3.2	-	W	
PDD Max	VDD Power max	-	3.5	-	W	
IDD	IDD Current	-	970	-	mArms	Note 1
IDD Max	IDD Current max	-	1060	310	mArms	Note 2
V <sub>RP</sub>	Power Ripple Voltage	-	100	-	mVp-p	
I <sub>RUSH</sub>	Inrush Current	-	1500	-	mApeak	

**Note 1:** Effective value (mArms) at V<sub>CC</sub> = 3.3 V/25°C.

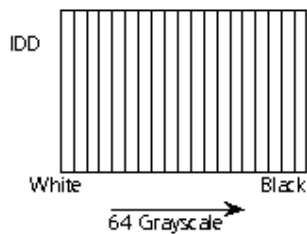

**Note 2:**

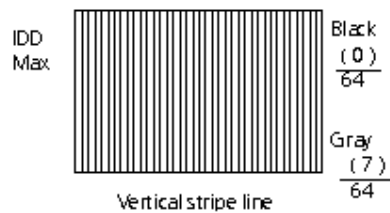



## 10.0 Power ON/OFF Sequence

VDD power and lamp on/off sequence is as follows. Interface signals are also shown in the chart. Signals from any system shall be Hi-Z state or low level when VDD is off.

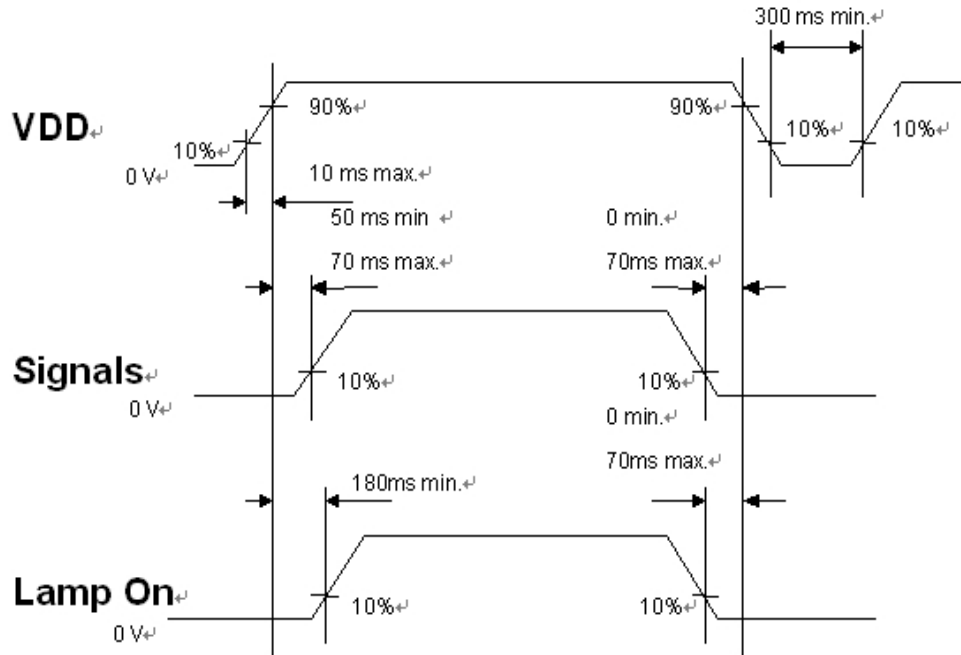



## 11.0 Mechanical Characteristics (front side)

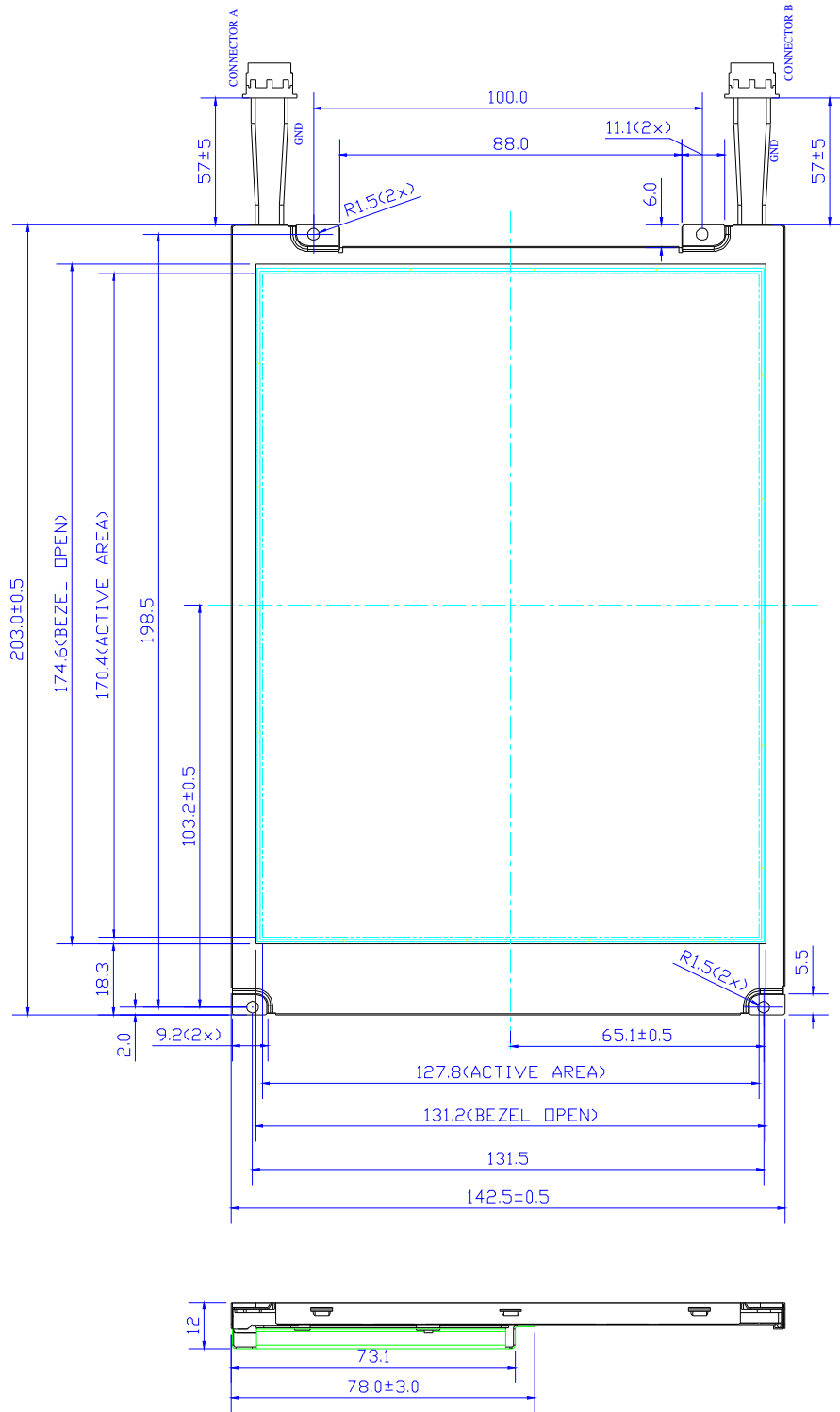





## 11.0 Mechanical Characteristics (back side)

