



# Product Specification

G170EG01 V0

AU OPTRONICS CORPORATION

( V ) Preliminary Specification

( ) Final Specification

<b>Module</b>	17.0" SXGA Color TFT-LCD
<b>Model Name</b>	G170EG01 V0

Customer	Date
_____	_____
<b>Approved by</b>	
<p>Note: This Specification is subject to change without notice.</p>	

Checked & Approved by	Date
<i>Debbie Chiu</i>	2009/ 5/ 21
<b>Prepared by</b>	
<i>Jimmy Tsai</i>	2009/5/15
<p>Desktop Display Business Group / AU Optronics corporation</p>	

## Contents

<b>1. Handling Precautions</b> .....	<b>4</b>
<b>2. General Description</b> .....	<b>5</b>
2.1 Display Characteristics .....	5
<b>3. Functional Block Diagram</b> .....	<b>10</b>
<b>4. Absolute Maximum Ratings</b> .....	<b>11</b>
4.1 TFT LCD Module .....	11
4.2 Backlight Unit.....	11
4.3 Absolute Ratings of Environment .....	11
<b>5. Electrical characteristics</b> .....	<b>12</b>
5.1 TFT LCD Module .....	12
5.2 Backlight Unit.....	14
<b>6. Signal Characteristic</b> .....	<b>15</b>
6.1 Pixel Format Image .....	15
6.2 The Input Data Format .....	15
6.4 Timing Characteristics .....	18
6.5 Power ON/OFF Sequence.....	20
<b>7. Connector &amp; Pin Assignment</b> .....	<b>21</b>
7.1 TFT LCD Module .....	21
7.2 Backlight Unit.....	22
<b>8. Reliability Test</b> .....	<b>23</b>
<b>9. Shipping Label</b> .....	<b>24</b>
<b>10. Mechanical Characteristics</b> .....	<b>25</b>



**Record of Revision**

Version and Date	Page	Old description	New Description	Remark
0.1 2009/5/15	All	First Edition for Customer	All	

## 1. Handling Precautions

- 1) Since front polarizer is easily damaged, pay attention not to scratch it.
- 2) Be sure to turn off power supply when inserting or disconnecting from input connector.
- 3) Wipe off water drop immediately. Long contact with water may cause discoloration or spots.
- 4) When the panel surface is soiled, wipe it with absorbent cotton or other soft cloth.
- 5) Since the panel is made of glass, it may break or crack if dropped or bumped on hard surface.
- 6) Since CMOS LSI is used in this module, take care of static electricity and insure human earth when handling.
- 7) Do not open or modify the Module Assembly.
- 8) Do not press the reflector sheet at the back of the module to any directions.
- 9) In case if a Module has to be put back into the packing container slot after once it was taken out from the container, do not press the center of the CCFL reflector edge. Instead, press at the far ends of the CCFL Reflector edge softly. Otherwise the TFT Module may be damaged.
- 10) At the insertion or removal of the Signal Interface Connector, be sure not to rotate nor tilt the Interface Connector of the TFT Module.
- 11) After installation of the TFT Module into an enclosure, do not twist nor bend the TFT Module even momentary. At designing the enclosure, it should be taken into consideration that no bending/twisting forces are applied to the TFT Module from outside. Otherwise the TFT Module may be damaged.
- 12) Cold cathode fluorescent lamp in LCD contains a small amount of mercury. Please follow local ordinances or regulations for disposal.
- 13) Small amount of materials having no flammability grade is used in the LCD module. The LCD module should be supplied by power complied with requirements of Limited Power Source (IEC60950 or UL1950), or be applied exemption.
- 14) The LCD module is designed so that the CCFL in it is supplied by Limited Current Circuit (IEC60950 or UL1950). Do not connect the CCFL in Hazardous Voltage Circuit.

## 2. General Description

This specification applies to the 17 inch Color TFT-LCD Module G170EG01 V0.

The display supports the SXGA+ (1280(H) x 1024(V)) screen format and 16.7M colors (RGB 6-bits+Hi-RFC data). All input signals are 2 Channel LVDS interface compatible.

This module does not contain an inverter card for backlight.

### 2.1 Display Characteristics

The following items are characteristics summary on the table under 25 °C condition:

Items	Unit	Specifications
Screen Diagonal	[mm]	432 (17.0")
Active Area	[mm]	337.920(H) x 270.336(V)
Pixels H x V		1280 x 3(RGB) x 1024
Pixel Pitch	[mm]	0.264(per one triad) x 0.264
Pixel Arrangement		R.G.B. Vertical Stripe
Display Mode		Normally White
White Luminance	[cd/m <sup>2</sup> ]	350 (center, Typ)@7.5 mA
Contrast Ratio		1000 : 1 (Typ)
Optical ResponseTime	[msec]	5 (Typ)
Nominal Input Voltage VDD	[Volt]	+5.0 (Typ)
Power Consumption (VDD line + CCFL line)	[Watt]	26.5W (Typ.) (without inverter, all black pattern)
Weight	[Grams]	2000 Typ.
Physical Size (H x V x D)	[mm]	358.5(H) x 296.5(V) Typ. x 15.8(D) Max.
Electrical Interface		Dual Channel LVDS
Surface Treatment		Anti-glare type, Hardness 3H
Support Color		16.7M colors (RGB 6-bits +Hi-FRC data)
Temperature Range Operating Storage (Non-Operating)	[°C] [°C]	0 to +50 -20 to +60
RoHS Compliance		RoHS Compliance
Digital Gamma turn on Compliance		TCO03 Compliance

## 2.2 Optical Characteristics

The optical characteristics are measured under stable conditions at 25°C (Room Temperature):

Item	Unit	Conditions	Min.	Typ.	Max.	Note
Viewing Angle	[degree]	Horizontal (Right) CR = 10 (Left)	70 70	85 85	-	1
		Vertical (Up) CR = 10 (Down)	70 70	80 80	-	
		Horizon (Right) CR = 5 (Left)	75 75	85 85	-	
		Vertical (Up) CR = 5 (Down)	75 75	85 85	-	
Luminance Uniformity	[%]	9 Points	75	80	-	2, 3
Optical Response Time	[msec]	Rising	-	3.5	6	4, 6
		Falling	-	1.5	3	
		Rising + Falling	-	5	9	
Color / Chromaticity Coordinates (CIE 1931)		Red x	0.618	0.648	0.678	4
		Red y	0.309	0.339	0.369	
		Green x	0.262	0.292	0.322	
		Green y	0.573	0.603	0.633	
		Blue x	0.113	0.143	0.173	
		Blue y	0.040	0.070	0.100	
		White x	0.283	0.313	0.343	
White y	0.299	0.329	0.359			
White Luminance (At CCFL= 7.5mA)	[cd/m <sup>2</sup> ]		280	350	-	4
Contrast Ratio			600	1000	-	4
Cross Talk (At 75Hz)	[%]		-	-	1.5	5
Flicker	[dB]		-	-	-20	7

Optical Equipment: BM-5A, BM-7, PR880, or equivalent

**Note 1: Definition of viewing angle**

Viewing angle is the measurement of contrast ratio  $\geq 10$ , at the screen center, over a  $180^\circ$  horizontal and  $180^\circ$  vertical range (off-normal viewing angles). The  $180^\circ$  viewing angle range is broken down as follows;  $90^\circ$  ( $\theta$ ) horizontal left and right and  $90^\circ$  ( $\Phi$ ) vertical, high (up) and low (down). The measurement direction is typically perpendicular to the display surface with the screen rotated about its center to develop the desired measurement viewing angle.

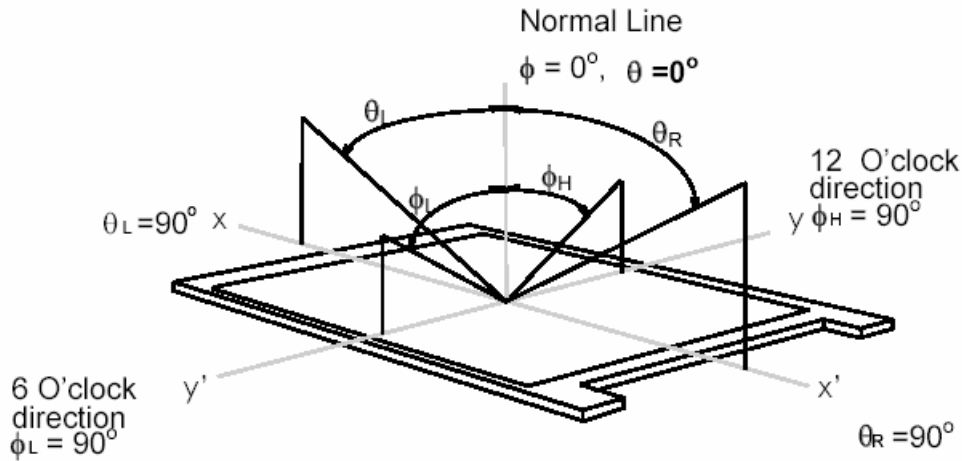

**Note 2: 9 points position**

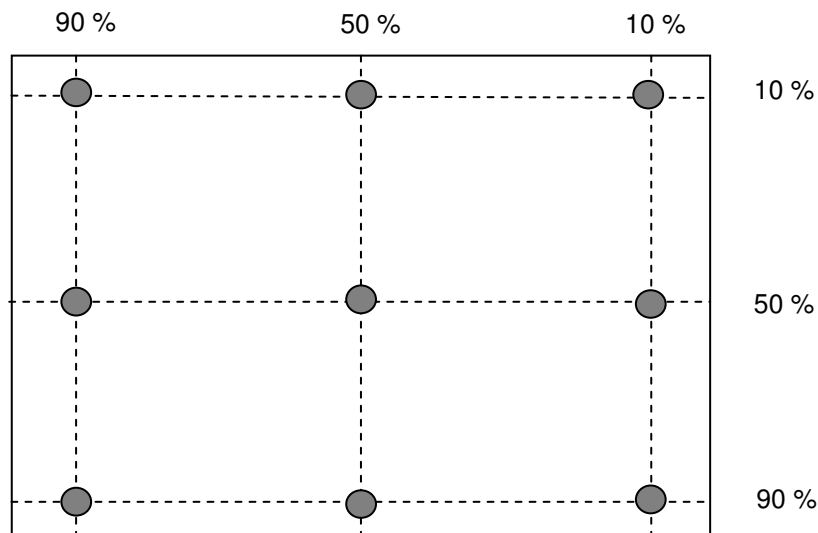

Note 3: The luminance uniformity of 9 points is defined by dividing the maximum luminance values by the minimum test point luminance

$$\delta_{w9} = \frac{\text{Minimum Luminance of 9 points}}{\text{Maximum Luminance of 9 points}}$$

**Note 4: Measurement method**

The LCD module should be stabilized at given temperature for 30 minutes to avoid abrupt temperature change during measuring. In order to stabilize the luminance, the measurement should be executed after lighting Backlight for 30 minutes in a stable, windless and dark room.

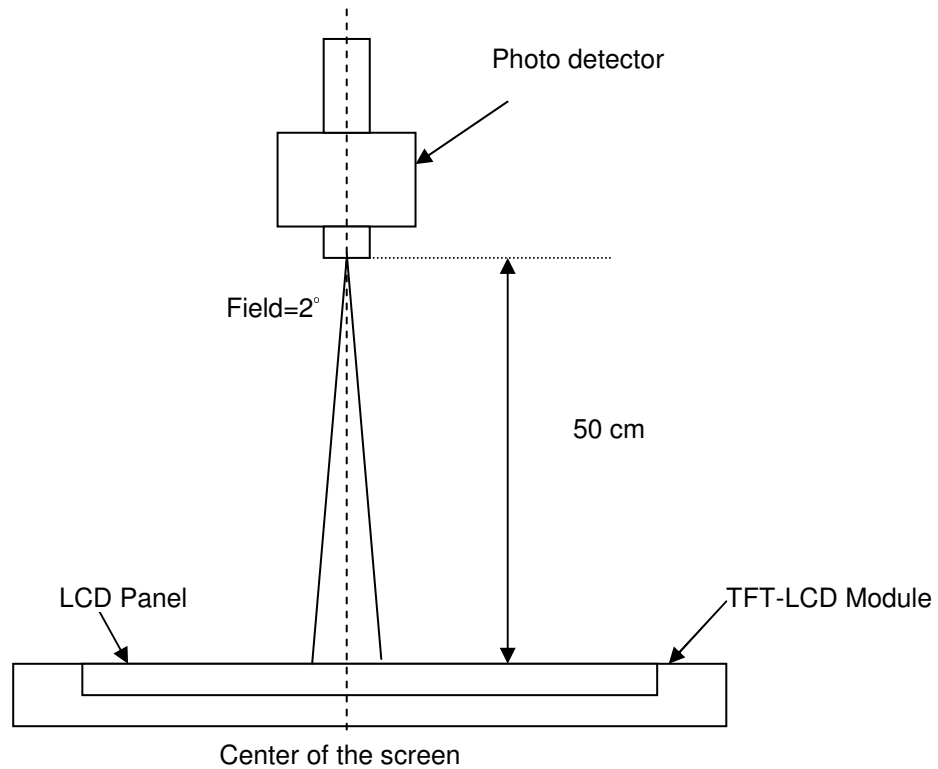

**Note 5: Definition of Cross Talk (CT)**

$$CT = | YB - YA | / YA \times 100 (\%)$$

Where

YA = Luminance of measured location without gray level 0 pattern (cd/m2)

YB = Luminance of measured location with gray level 0 pattern (cd/m2)

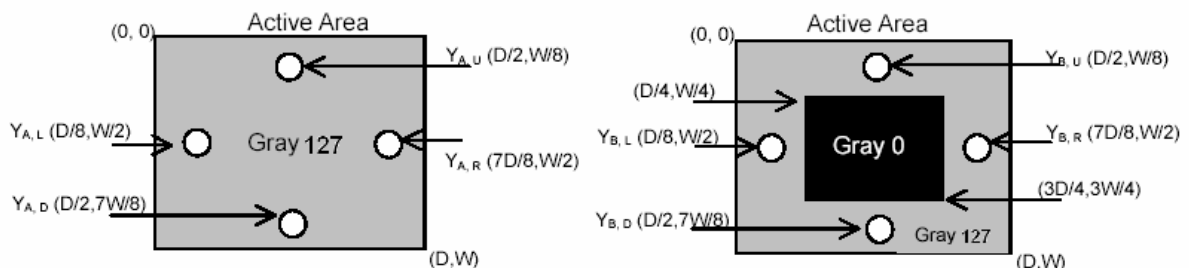



Note 6: Definition of response time:

The output signals of photo detector are measured when the input signals are changed from “Full Black” to “Full White” (rising time), and from “Full White” to “Full Black ”(falling time), respectively. The response time is interval between the 10% and 90% of amplitudes. Please refer to the figure as below.

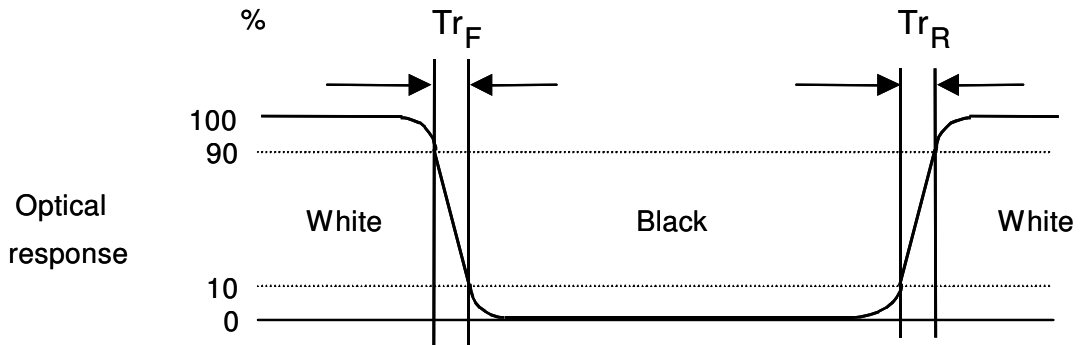

Note 7: Subchecker Pattern

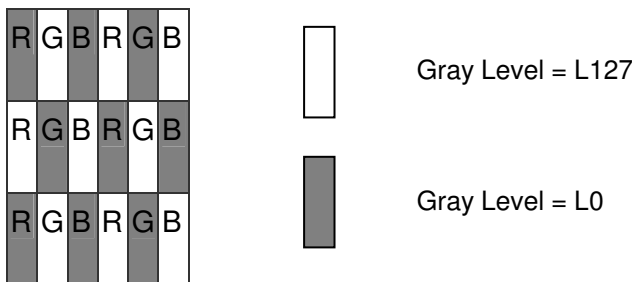

Method: Record dBV & DC value with (WESTAR)TRD-100

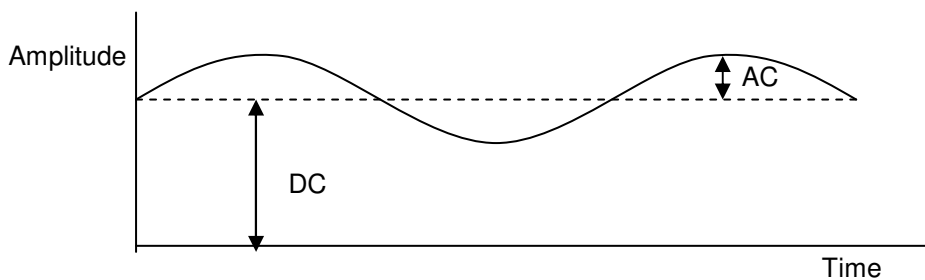

$$\text{Flicker (dB)} = 20 \log \frac{\text{AC Level(at 30 Hz)}}{\text{DC Level}}$$

### 3. Functional Block Diagram

The following diagram shows the functional block of the 17.0 inches Color TFT-LCD Module:

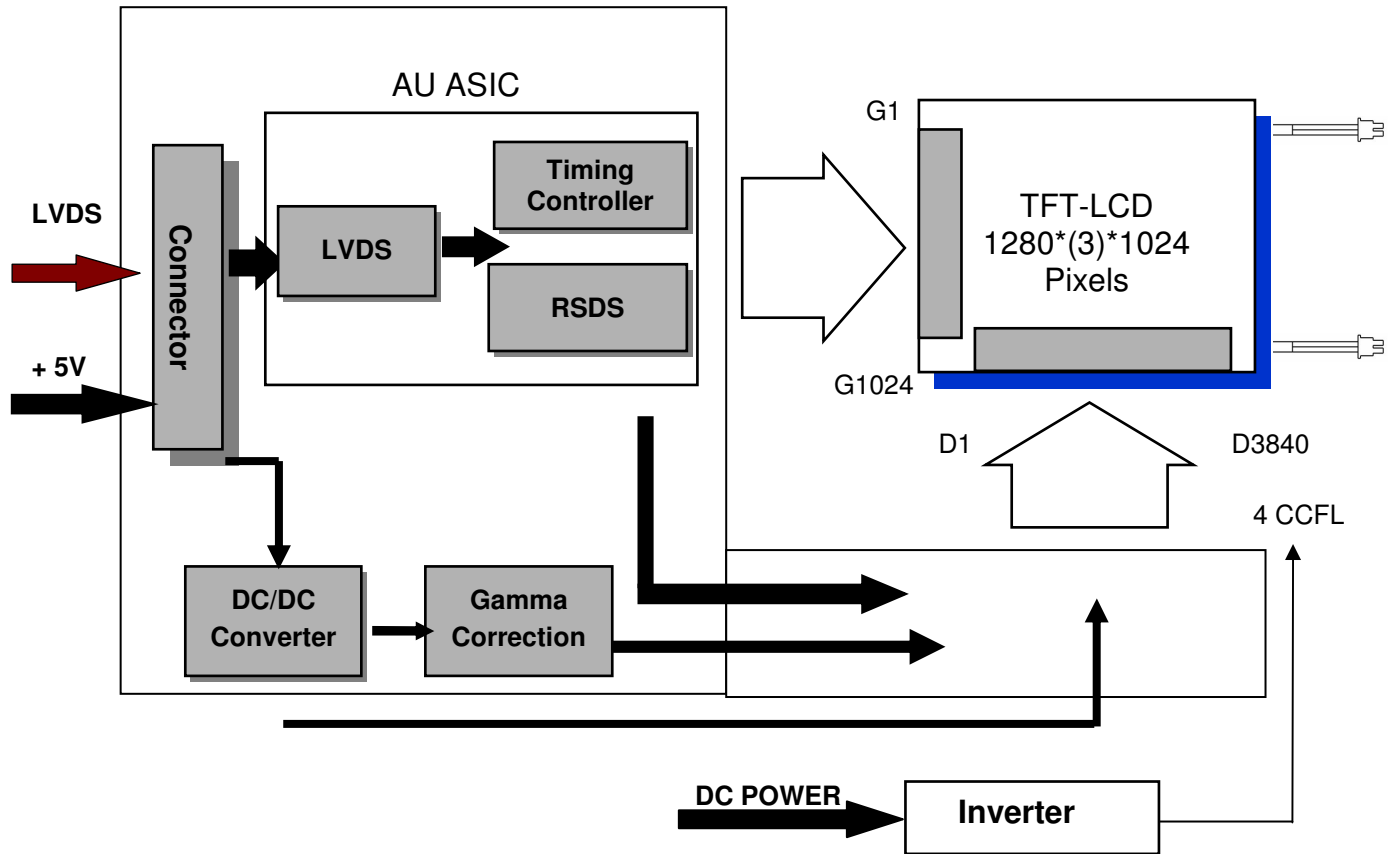

**PCBA Connector:**

JAE FI-XB30SSL-HF15  
Or Compatible

**CCFL Connector:**

YENONHO 35001HS-02L  
Or Compatible

## 4. Absolute Maximum Ratings

Absolute maximum ratings of the module is as following:

### 4.1 TFT LCD Module

Item	Symbol	Min	Max	Unit	Conditions
Logic/LCD Drive Voltage	VIN	-0.3	6	[Volt]	<i>Note 1,2</i>

### 4.2 Backlight Unit

Item	Symbol	Min	Max	Unit	Conditions
CCFL Current	ICFL	-	8	[mA] rms	<i>Note 1,2</i>

### 4.3 Absolute Ratings of Environment

Item	Symbol	Min	Max	Unit	Conditions
Operating Humidity	HOP	5	90	[%RH]	<i>Note 3</i>
Storage Temperature	TST	-20	+60	[°C]	
Storage Humidity	HST	5	90	[%RH]	

**Note 1:** With in Ta (25°C )

**Note 2:** Permanent damage to the device may occur if exceed maximum values

**Note 3:** For quality performance, please refer to AUO IIS (Incoming Inspection Standard).

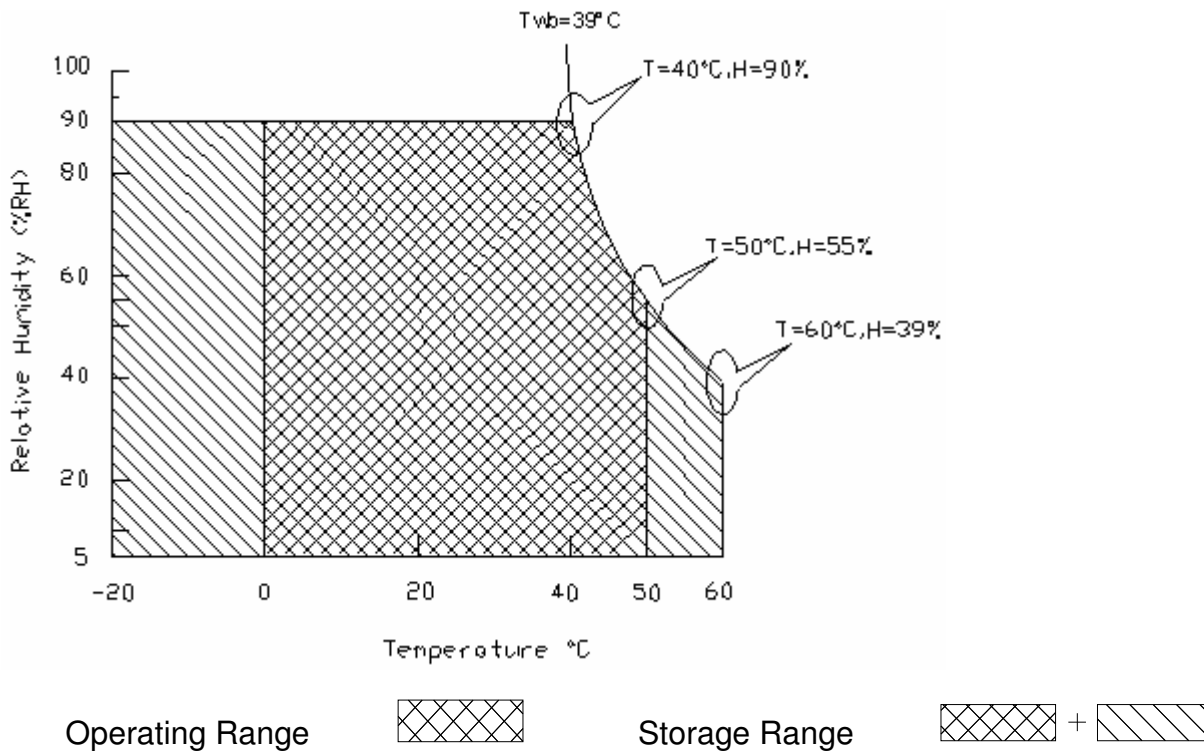

## 5. Electrical characteristics

### 5.1 TFT LCD Module

#### 5.1.1 Power Specification

Input power specifications are as follows:

Symble	Parameter	Min.	Typ.	Max.	Unit	Condition
VCC	Logic/LCD Drive Voltage	4.5	5.0	5.5	[Volt]	±10%
ICC	Input Current	-	1.05	1.16	[A]	Vin=5V , All Black Pattern, at 75Hz
IRush	Inrush Current	-	-	3.0	[A]	Note
PCC	VCCPower	-	5.25	5.8	[Watt]	Vin=5V , All Black Pattern, at 75Hz
VCCrp	Allowable Logic/LCD Drive Ripple Voltage	-	-	200	[mV] p-p	With panel loading

Note: Measurement conditions:

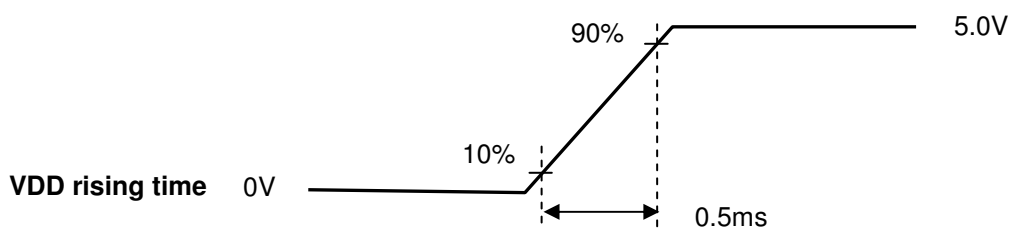
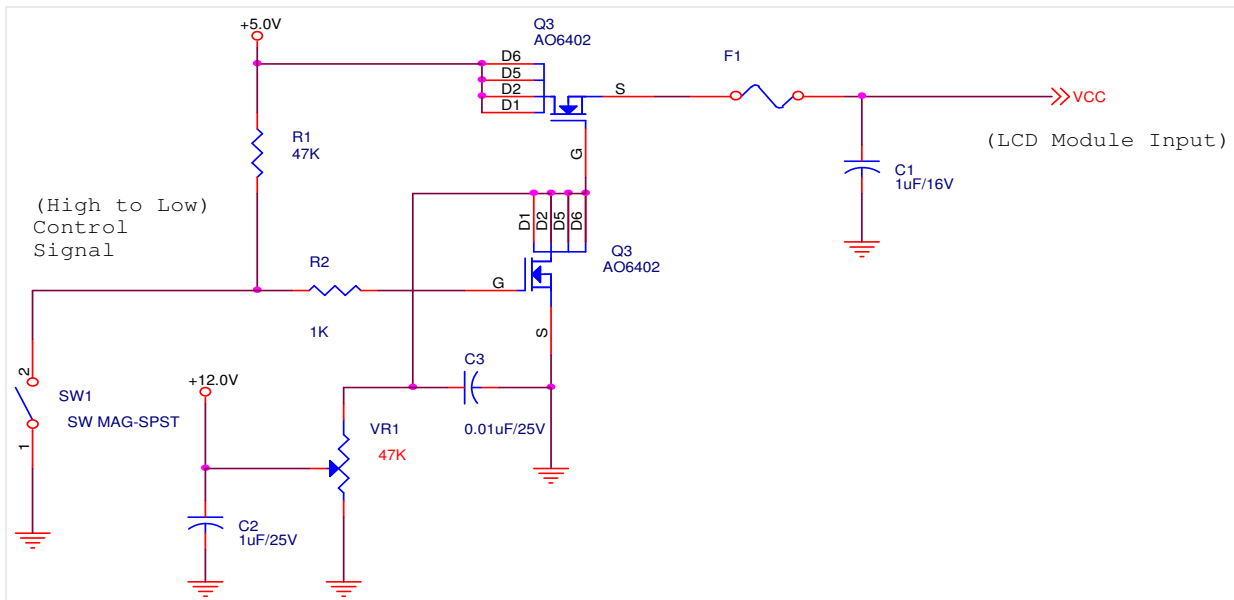

## 5.1.2 Signal Electrical Characteristics

Input signals shall be low or Hi-Z state when Vin is off

It is recommended to refer the specifications of SN75LVDS82DGG (Texas Instruments) in detail.

Each signal characteristics are as follows;

Symbol	Parameter	Min	Typ	Max	Units	Condition
VTH	Differential Input High Threshold	-	-	+100	[mV]	VICM = 1.2V <b>Note</b>
VTL	Differential Input Low Threshold	-100	-	-	[mV]	VICM = 1.2V <b>Note</b>
VID	Input Differential Voltage	100	400	600	[mV]	<b>Note</b>
VICM	Differential Input Common Mode Voltage	+1.0	+1.2	+1.5	[V]	VTH/VTL = ±100mV <b>Note</b>

**Note:** LVDS Signal Waveform

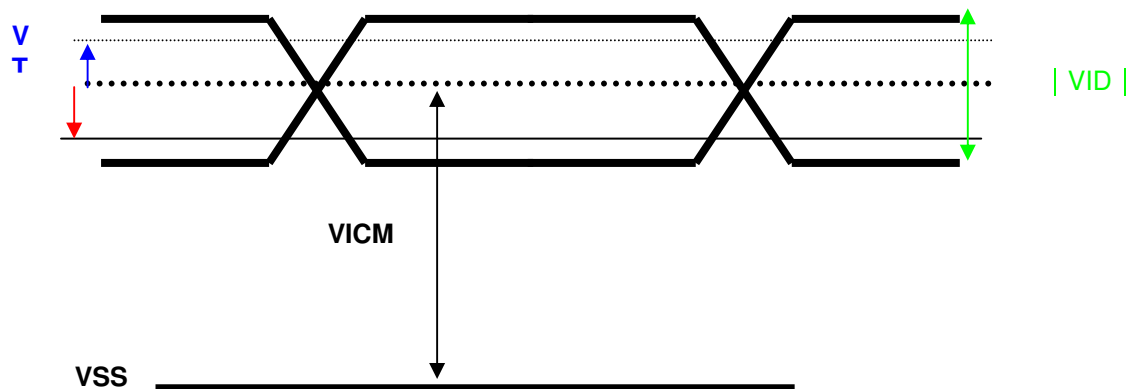

## 5.2 Backlight Unit

Parameter guideline for CCFL Inverter

Parameter	Min.	Typ.	Max.	Unit	Condition
CCFL standard current(ISCFL)	7	7.5	8	[mA] rms	(Ta=25°C) <b>Note 2</b>
CCFL Operation Current (IRCFL)	3	7.5	8	[mA] rms	(Ta=25°C) <b>Note 2</b>
CCFL Frequency (FCFL)	40	60	80	[KHz]	(Ta=25°C) <b>Note 3,4</b>
CCFL Ignition Voltage (ViCFL, Ta= 0°C)	1500	-		[Volt] rms	(Ta=0°C) <b>Note 5</b>
CCFL Ignition Voltage (ViCF, Ta= 25°C)	1100	-		[Volt] rms	(Ta=25°C) <b>Note 5</b>
CCFL Operation Voltage (VCFL)	-	680 @ 7.5mA	-	[Volt] rms	(Ta=25°C) <b>Note 6</b>
CCFL Power Consumption (PCFL)	-	20.5	-	[Watt]	(Ta=25°C) <b>Note 6</b>
CCFL Life Time (LTCFL)	40,000	50,000	-	[Hour]	(Ta=25°C)

Note 1: Typ. are AUO recommended design points.

- \*1 All of characteristics listed are measured under the condition using the AUO test inverter.
- \*2 In case of using an inverter other than listed, it is recommended to check the inverter carefully. Sometimes, interfering noise stripes appear on the screen, and substandard luminance or flicker at low power may happen.
- \*3 In designing an inverter, it is suggested to check safety circuit very carefully. Impedance of CCFL, for instance, becomes more than 1 [M ohm] when CCFL is damaged.
- \*4 Generally, CCFL has some amount of delay time after applying kick-off voltage. It is recommended to keep on applying kick-off voltage for 1 [Sec] until discharge.
- \*5 Reducing CCFL current increases CCFL discharge voltage and generally increases CCFL discharge frequency. So all the parameters of an inverter should be carefully designed so as not to produce too much leakage current from high-voltage output of the inverter.

Note 2: It should be employed the inverter which has “Duty Dimming”, if IRCFL is less than 3mA.

Note 3: CCFL discharge frequency should be carefully determined to avoid interference between inverter and TFT LCD.

Note 4: The frequency range will not affect to lamp life and reliability characteristics.

Note 5: CCFL inverter should be able to give out a power that has a generating capacity of over 1,500 voltage. Lamp units need 1,500 voltage minimum for ignition.

Note 6: The variance of CCFL power consumption is ±10%. Calculator value for reference (ISCFL × VCFL × 4= PCFL)

Note 7: Definition of Life time: Brightness becomes 50%. The typical life time CCFL in on the condition at 7.5 mA lamp current.

## 6. Signal Characteristic

### 6.1 Pixel Format Image

Following figure shows the relationship of the input signals and LCD pixel format.

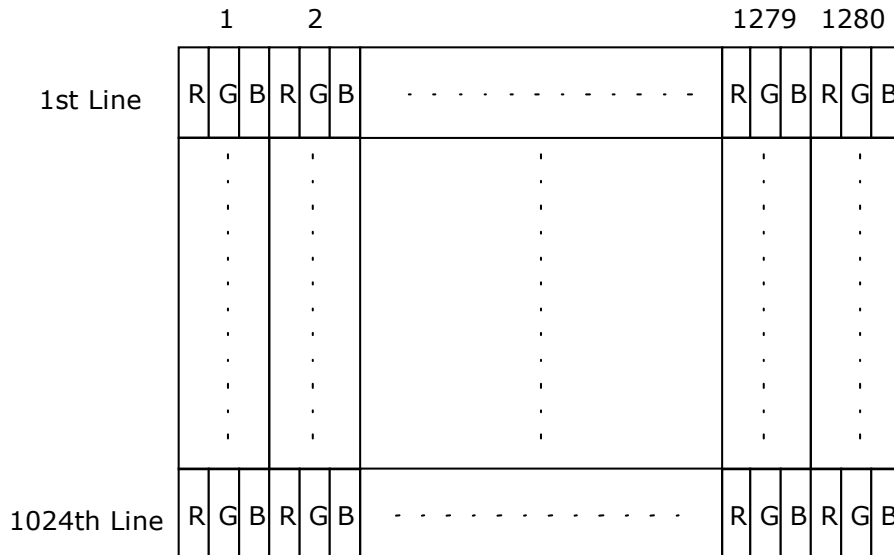

### 6.2 The Input Data Format

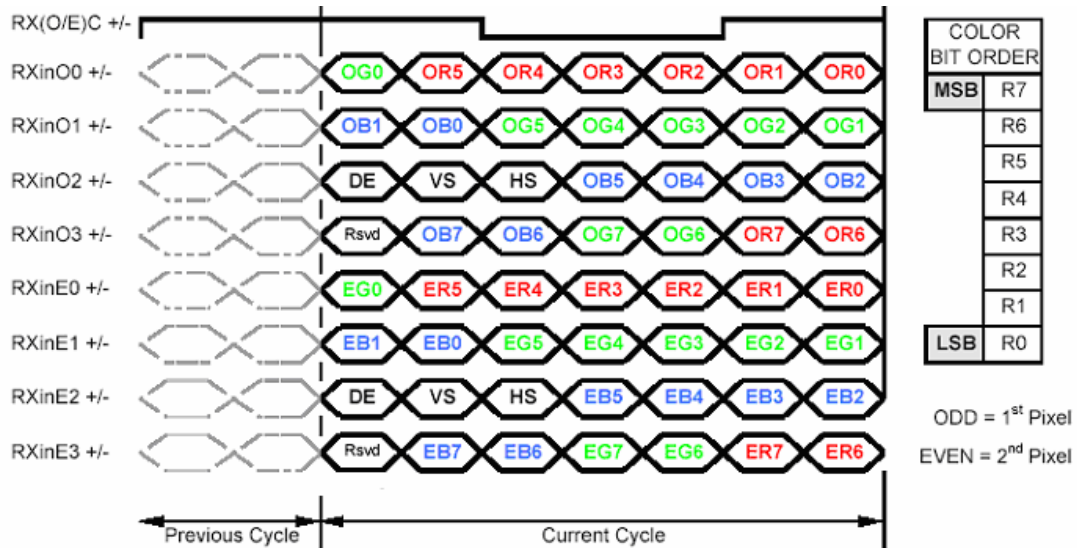

- Note1: Normally, DE, VS, HS on EVEN channel are not used.
- Note2: Please follow PSWG.
- Note3: 8-bit in

## 6.3 Signal Description

The module using a pair of LVDS receiver SN75LVDS82(Texas Instruments) or compatible. LVDS is a differential signal technology for LCD interface and high speed data transfer device. Transmitter shall be SN75LVDS83(negative edge sampling) or compatible. The first LVDS port(RxOxxx) transmits odd pixels while the second LVDS port(RxExxx) transmits even pixels.

PIN #	SIGNAL NAME	DESCRIPTION
1	RxO0-	Negative LVDS differential data input (Odd data)
2	RxO0+	Positive LVDS differential data input (Odd data)
3	RxO1-	Negative LVDS differential data input (Odd data)
4	RxO1+	Positive LVDS differential data input (Odd data)
5	RxO2-	Negative LVDS differential data input (Odd data, H-Sync,V-Sync,DSPTMG)
6	RxO2+	Positive LVDS differential data input (Odd data, H-Sync,V-Sync,DSPTMG)
7	GND	Power Ground
8	RxOC-	Negative LVDS differential clock input (Odd clock)
9	RxOC+	Positive LVDS differential clock input (Odd clock)
10	RxO3-	Negative LVDS differential data input (Odd data)
11	RxO3+	Positive LVDS differential data input (Odd data)
12	RxE0-	Negative LVDS differential data input (Even data)
13	RxE0+	Positive LVDS differential data input (Even data)
14	GND	Power Ground
15	RxE1-	Negative LVDS differential data input (Even data)
16	RxE1+	Positive LVDS differential data input (Even data)
17	GND	Power Ground
18	RxE2-	Negative LVDS differential data input (Even data)
19	RxE2+	Positive LVDS differential data input (Even data)
20	RxEC-	Negative LVDS differential clock input (Even clock)
21	RxEC+	Positive LVDS differential clock input (Even clock)
22	RxE3-	Negative LVDS differential data input (Even data)
23	RxE3+	Positive LVDS differential data input (Even data)
24	GND	Power Ground
25	GND	Power Ground (For AUO test Aging+HVS mode )
26	NC	No contact
27	GND	Power Ground
28	VCC	+5.0V Power Supply
29	VCC	+5.0V Power Supply
30	VCC	+5.0V Power Supply



Note1: Start from left side

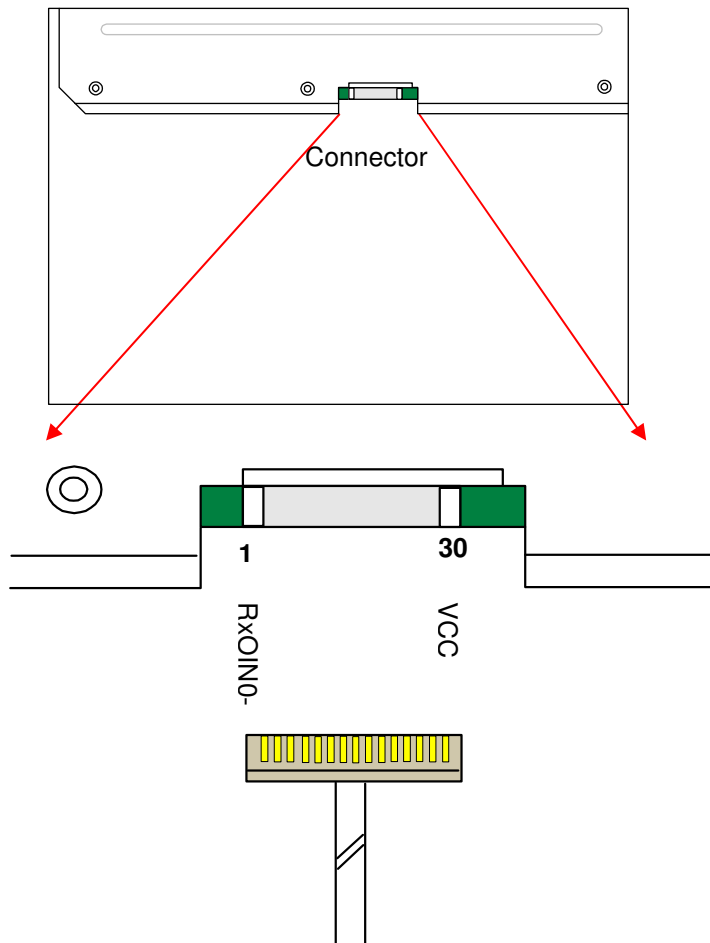

Note2: Input signals of odd and even clock shall be the same timing.

Note3: Please follow PSWG.

## 6.4 Timing Characteristics

### 6.4.1 Timing Characteristics

Basically, interface timings described here is not actual input timing of LCD module but output timing of SN75LVDS82DGG (Texas Instruments) or equivalent.

Signal	Item	Symbol	Min	Typ	Max	Unit
Vertical Section	Period	$T_v$	1034	1066	2048	Th
	Active	$T_{disp(v)}$	1024	1024	1024	Th
	Blanking	$T_{bp(v)}+T_{fp(v)}+PW_{vs}$	10	42	1024	Th
Horizontal Section	Period	$T_h$	750	844	2048	Tclk
	Active	$T_{disp(h)}$	640	640	640	Tclk
	Blanking	$T_{bp(h)}+T_{fp(h)}+PW_{hs}$	110	204	1408	Tclk
Clock	Period	Tclk	14.81	18.52	25	ns
	Frequency	Freq	40	54	70	MHz
Frame rate	Frame rate	F	49	60	76	Hz

**Note** : DE mode only

## 6.4.2 Timing Diagram

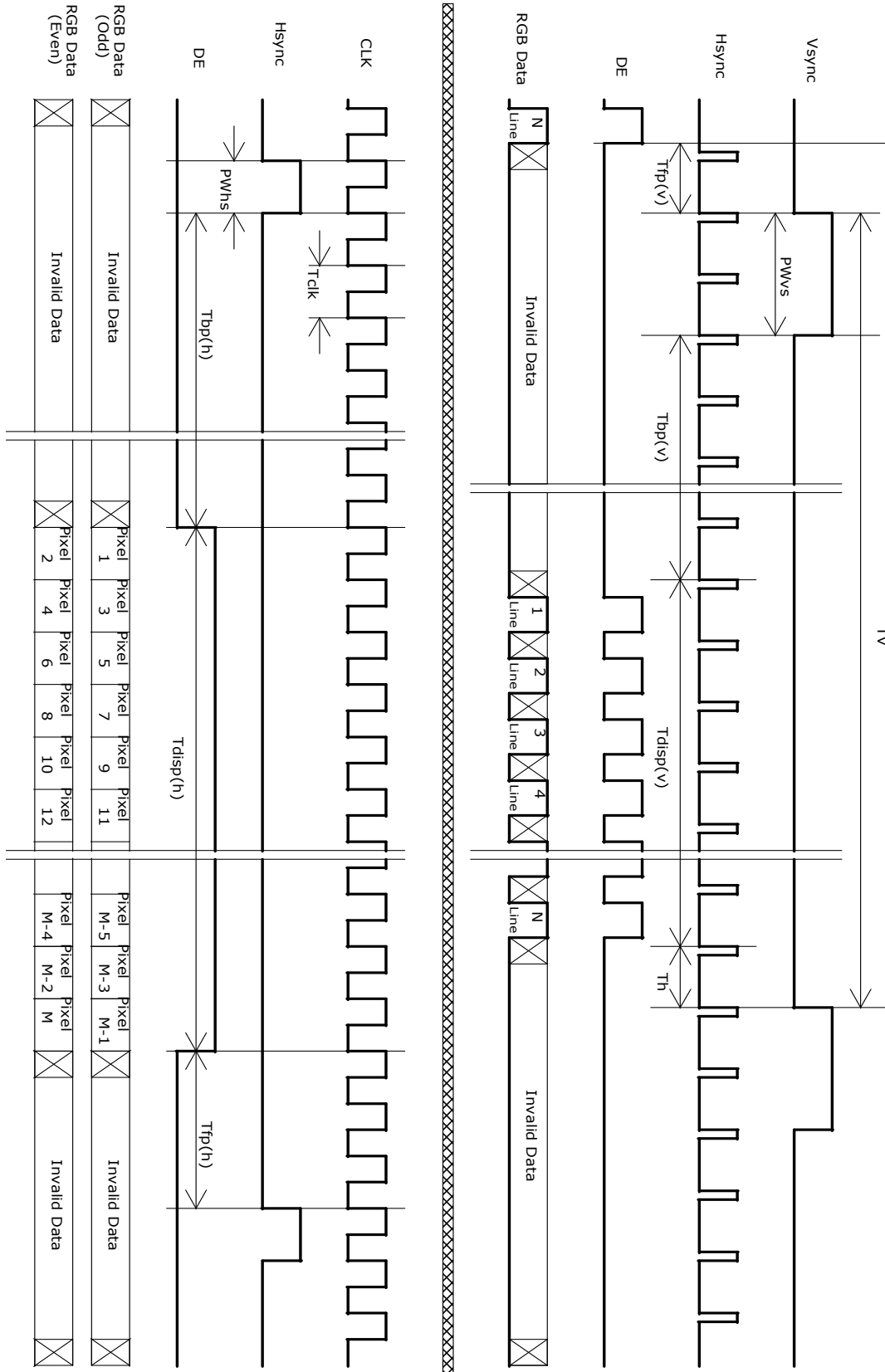

## 6.5 Power ON/OFF Sequence

VDD power and lamp on/off sequence is as follows. Interface signals are also shown in the chart. Signals from any system shall be Hi-Z state or low level when VDD is off.

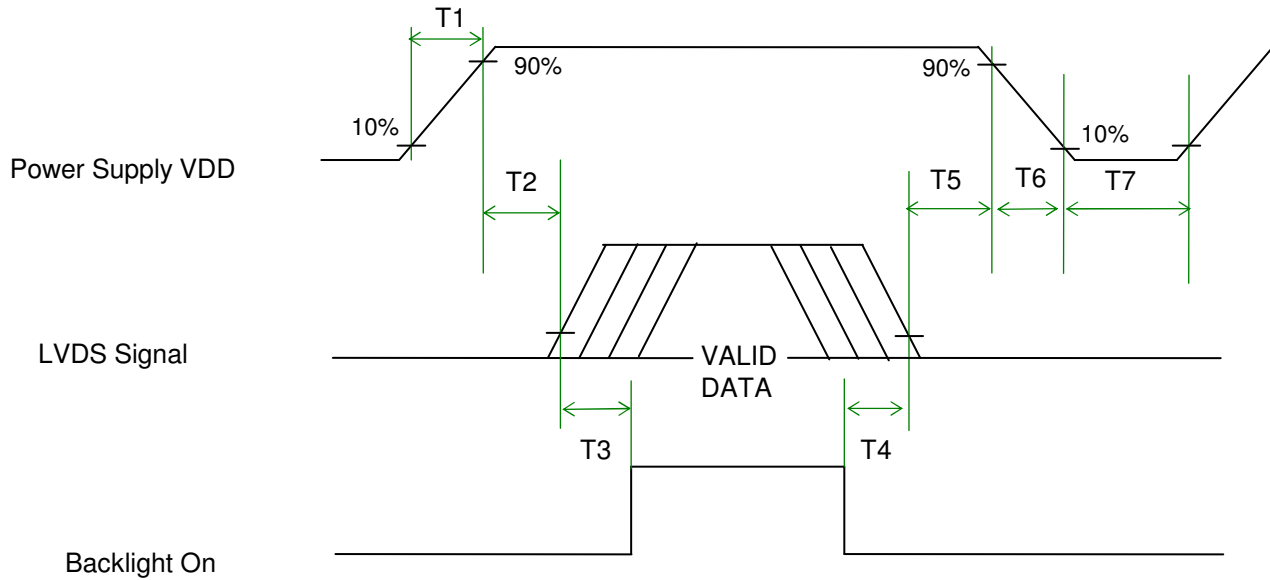

**Power Sequence Timing**

Parameter	Value			Unit
	Min.	Typ.	Max.	
T1	0.5	-	10	[ms]
T2	0	-	50	[ms]
T3	300	-	-	[ms]
T4	100	-	-	[ms]
T5	0	16	50	[ms]
T6	-	-	-	[ms]
T7	1000	-	-	[ms]

Note: The values of the table are follow PSWG.

## 7. Connector & Pin Assignment

Physical interface is described as for the connector on module. These connectors are capable of accommodating the following signals and will be following components.

### 7.1 TFT LCD Module

#### 7.1.1 Connector

Connector Name / Designation	Interface Connector
Manufacturer	JAE or Compatible
Type Part Number	FI-XB30SSL-HF15 or Compatible
Mating Housing Part Number	JAE FI-X30HL or Compatible

#### 7.1.2 Pin Assignment

Pin#	Signal Name	Pin#	Signal Name
1	RxOIN0-	2	RxOIN0+
3	RxOIN1-	4	RxOIN1+
5	RxOIN2-	6	RxOIN2+
7	GND	8	RxOCLKIN-
9	RxOCLKIN+	10	RxOIN3-
11	RxOIN3+	12	RxEIN0-
13	RxEIN0+	14	GND
15	RxEIN1-	16	RxEIN1+
17	GND	18	RxEIN2-
19	RxEIN2+	20	RxECLKIN-
21	RxECLKIN+	22	RxEIN3-
23	RxEIN3+	24	GND
25	GND (AGMODE+HVS)	26	NC
27	GND	28	VCC
29	VCC	30	VCC

## 7.2 Backlight Unit

Physical interface is described as for the connector on module. These connectors are capable of accommodating the following signals and will be following components.

Connector Name / Designation	Lamp Connector
Manufacturer	YENONHO or Compatible
Type Part Number	35001HS-02L or Compatible
Mating Type Part Number	35001WR-00LS00 or Compatible

### 7.2.1 Signal for Lamp connector

	Connector No.	Pin No.	Input	Color	Function
Upper	CN1	1	Hot1	Pink	High Voltage (Lamp 1)
		2	Cold1	White	Low Voltage (Lamp 1)
	CN2	1	Hot2	Blue	High Voltage (Lamp 2)
		2	Cold2	Black	Low Voltage (Lamp 2)

	Connector No.	Pin No.	Input	Color	Function
Lower	CN3	1	Hot1	Pink	High Voltage (Lamp 3)
		2	Cold1	White	Low Voltage (Lamp 3)
	CN4	1	Hot2	Blue	High Voltage (Lamp 4)
		2	Cold2	Black	Low Voltage (Lamp 4)

## 8. Reliability Test

Environment test conditions are listed as following table.

Items	Required Condition	Note
Temperature Humidity Bias (THB)	Ta= 50°C, 80%RH, 300hours	
High Temperature Operation (HTO)	Ta= 50°C, 50%RH, 300hours	
Low Temperature Operation (LTO)	Ta= 0°C, 300hours	
High Temperature Storage (HTS)	Ta= 60°C, 300hours	
Low Temperature Storage (LTS)	Ta= -20°C, 300hours	
Vibration Test (Non-operation)	Acceleration: 1.5 G Wave: Random Frequency: 10 - 200 - 10 Hz Sweep: 30 Minutes each Axis (X, Y, Z)	
Shock Test (Non-operation)	Acceleration: 50 G Wave: Half-sine Active Time: 20 ms Direction: ±X, ±Y, ±Z (one time for each Axis)	
Drop Test	Height: 60 cm, package test	
Thermal Shock Test (TST)	-20°C/30min, 60°C/30min, 100 cycles	1
On/Off Test	On/10sec, Off/10sec, 30,000 cycles	
ESD (ElectroStatic Discharge)	Contact Discharge: ± 8KV, 150pF(330Ω ) 1sec, 8 points, 25 times/ point.	2
	Air Discharge: ± 15KV, 150pF(330Ω ) 1sec 8 points, 25 times/ point.	
Altitude Test	Operation:10,000 ft Non-Operation:30,000 ft	





Note 1: The TFT-LCD module will not sustain damage after being subjected to 100 cycles of rapid temperature change. A cycle of rapid temperature change consists of varying the temperature from -20°C to 60°C, and back again. Power is not applied during the test. After temperature cycling, the unit is placed in normal room ambient for at least 4 hours before power on.

Note 2: According to EN61000-4-2 , ESD class B: Some performance degradation allowed. No data lost. Self-recoverable. No hardware failures.

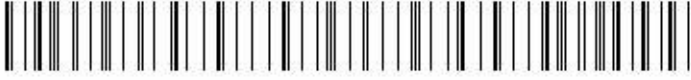

### 9. Shipping Label

The shipping label format is shown as below.

	Manufactured XX/XX			
*XXXXXXXXXXXX-XXXX*	Model No: <b>G170EG01</b>	V.0		
	AU Optronics	XXXXX		
	MADE IN XXXXXX (XX)			
				
	XXXXXXXXXXXXXXXXXXXX			



## 10. Mechanical Characteristics

