

## **Product Specifications**

**15.0" XGA Color TFT-LCD Module**  
**Model Name:M150XN04**  
**V.1**

**(◆) Preliminary Specifications**  
**( ) Final Specifications**

# **i Contents**

## **1.0 Handling Precautions**

## **2.0 General Description**

- 2.1 Display Characteristics
- 2.2 Functional Block Diagram

## **3.0 Absolute Maximum Ratings**

## **4.0 Optical Characteristics**

- 4.1 Signal for Lamp connector
- 4.2 Parameter guideline for CCFL Inverter

## **5.0 Signal Interface**

- 5.1 Module Interface Connectors
- 5.2 Module Connector Pin Configuration
- 5.3 Backlight Connectors
- 5.4 Backlight Connector Pin Configuration
- 5.5 Signal Electrical Characteristics
- 5.6 Interface Timings Characteristics
- 5.7 Interface Timing Definition

## **6.0 Pixel format image**

## **7.0 Power Consumption**

## **8.0 Power ON/OFF Sequence**

## **9.0 Backlight Characteristics**

- 9.1 Signal for Lamp connector
- 9.2 Parameter guide line for CCFL Inverter

## **10.0 Label, Vibration, Shock, and Drop**

- 10.1 Label
- 10.2 Vibration & Shock
  - 10.2.1 Vibration Test Spec
  - 10.2.2 Shock Test Spec
- 10.3 Drop

## **11.0 Environment**

- 11.1 Temperature and Humidity
  - 11.1.1 Operating Conditions
  - 11.1.2 Shipping Conditions
- 11.2 Atmospheric Pressure
- 11.3 Thermal Shock

## **12.0 Reliability**

- 12.1 Failure criteria
- 12.2 Failure rate
  - 12.2.1 Usage
  - 12.2.2 Components de-rating
- 12.3 CCFL life
- 12.4 ON/OFF cycle

## **13.0 Safety**

(C) Copyright AU Optronics, Inc.

Oct. 2001 All Rights Reserved.

M150XN05-1 Ver0.1

2/27

No Reproduction and Redistribution Allowed.

- 13.1 Sharp edge requirement
- 13.2 Material
  - 13.2.1 Toxicity
  - 13.2.2 Flammability
- 13.3 Capacitors
- 13.4 Hazardous voltage

**14.0 Other requirements**

- 14.1 Smoke free design
- 14.2 National test lab requirement

**15.0 Packing dimension**

**16.0 Mechanical Characteristics**

**ii Record of Revision**

Version and Date	Page	Old description	New Description	Remark
0.1 2002/01/30	All	First Edition for Customer	All	

## 1.0 Handling Precautions

- 1) Since front polarizer is easily damaged, pay attention not to scratch it.
- 2) Be sure to turn off power supply when inserting or disconnecting from input connector.
- 3) Wipe off water drop immediately. Long contact with water may cause discoloration or spots.
- 4) When the panel surface is soiled, wipe it with absorbent cotton or other soft cloth.
- 5) Since the panel is made of glass, it may break or crack if dropped or bumped on hard surface.
- 6) Since CMOS LSI is used in this module, take care of static electricity and insure human earth when handling.
- 7) Do not open nor modify the Module Assembly.
- 8) Do not press the reflector sheet at the back of the module to any directions.
- 9) In case if a Module has to be put back into the packing container slot after once it was taken out from the container, do not press the center of the CCFL Reflector edge. Instead, press at the far ends of the CFL Reflector edge softly. Otherwise the TFT Module may be damaged.
- 10) At the insertion or removal of the Signal Interface Connector, be sure not to rotate nor tilt the Interface Connector of the TFT Module.
- 11) After installation of the TFT Module into an enclosure (LCD monitor housing, for example), do not twist nor bend the TFT Module even momentary. At designing the enclosure, it should be taken into consideration that no bending/twisting forces are applied to the TFT Module from outside. Otherwise the TFT Module may be damaged.
- 12) Cold cathode fluorescent lamp in LCD contains a small amount of mercury. Please follow local ordinances or regulations for disposal.
- 13) Small amount of materials having no flammability grade is used in the LCD module. The LCD module should be supplied by power complied with requirements of Limited Power Source(2.11, IEC60950 or UL1950), or be applied exemption.
- 14) The LCD module is designed so that the CFL in it is supplied by Limited Current Circuit(2.4, IEC60950 or UL1950). Do not connect the CFL in Hazardous Voltage Circuit.

## 2.0 General Description

(C) Copyright AU Optronics, Inc.

Oct. 2001 All Rights Reserved.

M150XN05-1 Ver0.1

4/27

No Reproduction and Redistribution Allowed.

This specification applies to the 15.0 inch Color TFT-LCD Module M150XN05.

The display supports the XGA (1024(H) x 768(V)) screen format and 262,144 colors (RGB 6-bits data).

All input signals are 2 Channel TTL interface compatible.

This module does not contain an inverter card for backlight.

## Features

- XGA 1024(H) x 768(V) resolution
- 4 CCFLs (Cold cathode Fluorescent Lamp)
- High contrast ratio, high aperture ratio
- Wide viewing angle
- High speed response
- Low power consumption

## Application

Desktop monitors

### 2.1 Display Characteristics

The following items are characteristics summary on the table under 25 °C condition:

ITEMS	Unit	SPECIFICATIONS
Screen diagonal	[mm]	381 (15")
Outline dimension	[mm]	326 x 249.0 x 14.68(max)
Display Area	[mm]	304.128 (H) x 228.096(38.1cm diagonal)
Resolution		1024(R,G,B x 3) x 768
Pixel Pitch	[mm]	0.297 x 0.297
Pixel Arrangement		R.G.B. Vertical Stripe
Display Mode		TN mode, Normally White
Typical white Luminance.	[cd/m <sup>2</sup> ]	450nit (typ) @6.5mA,500nit (typ) @8mA (note 1)
Brightness uniformity		80% typ. (note 2)
Luminance uniformity		1.7 max.(Note 3)
Brightness variation		15% max.(note4)
Crosstalk (at 60Hz and 75 Hz)		1.2% max. (note 4)
Contrast Ratio		400 : 1 typ.
Support Colors		262,144 colors (6-bit for R,G,B)
Chromaticity(CIE1931)		0.313
White-x		
White-y		0.329
Color Gamut		60% typ., of NTSC coverage
Viewing angle		75(left),75(right),70(up),70(down)
Response Time	[msec]	16ms typ. (Tr +Tf)
Nominal Input Voltage VDD	[Volt]	+3.3 V
Power Consumption (VDD line + CCFL line)	[Watt]	
Electrical Interface		TTL 2 port
Frame rate	[Hz]	60Hz typ., 75Hz max.
Weight	[Grams]	1350 typ.
Mounting method		Side mounting
Surface treatment		Anti-glare, hard coating (3H)
Temperature Range Operating	[°C]	0 to +50

Storage (Shipping)	[°C]	-20 to +60
--------------------	------	------------

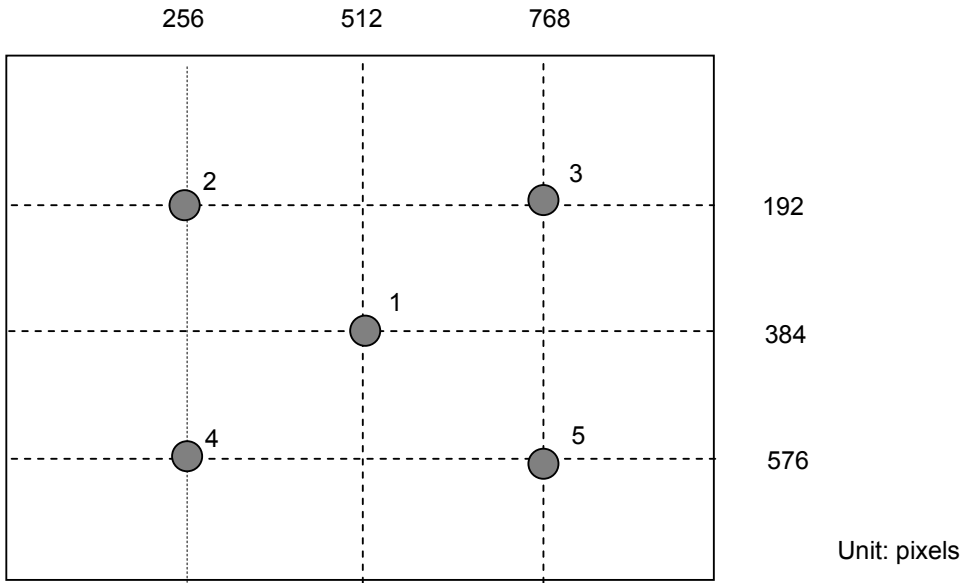

Note 1: Brightness is measured at the center point of brightness value with all pixels displaying white.

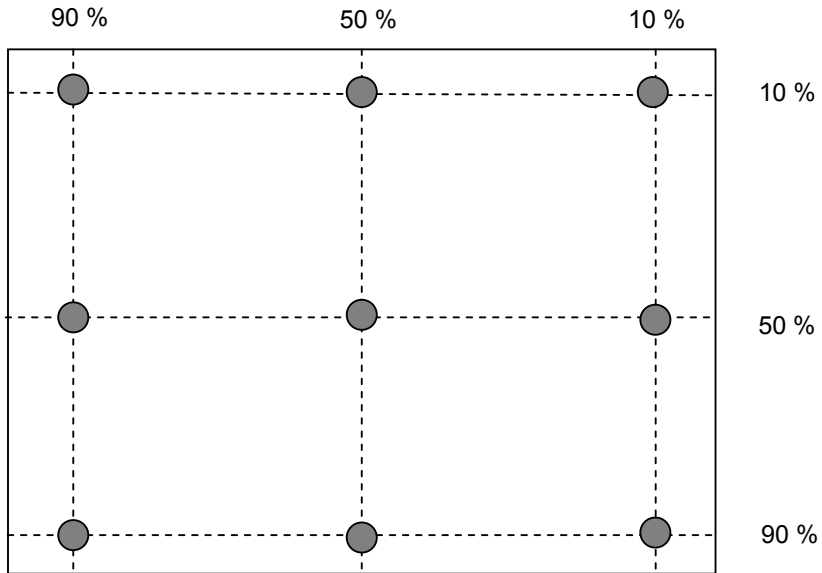

Unit: percentage of dimension of display area

Note 2: Brightness uniformity of these 9 points is defined as below:

$$(\text{Min. brightness} / \text{Max. brightness}) \times 100\%$$

Note 3: TCO '99 Certification Requirements and test methods for environmental labeling of Display Report No. 2 defines Luminance uniformity as below:

(C) Copyright AU Optronics, Inc.

Oct. 2001 All Rights Reserved.

M150XN05-1 Ver0.1

6/27

No Reproduction and Redistribution Allowed.

$$\frac{((L_{\max,+30\text{deg.}} / L_{\min,+30\text{deg.}}) + (L_{\max,-30\text{deg.}} / L_{\min,-30\text{deg.}}))}{2}$$

Note 4:

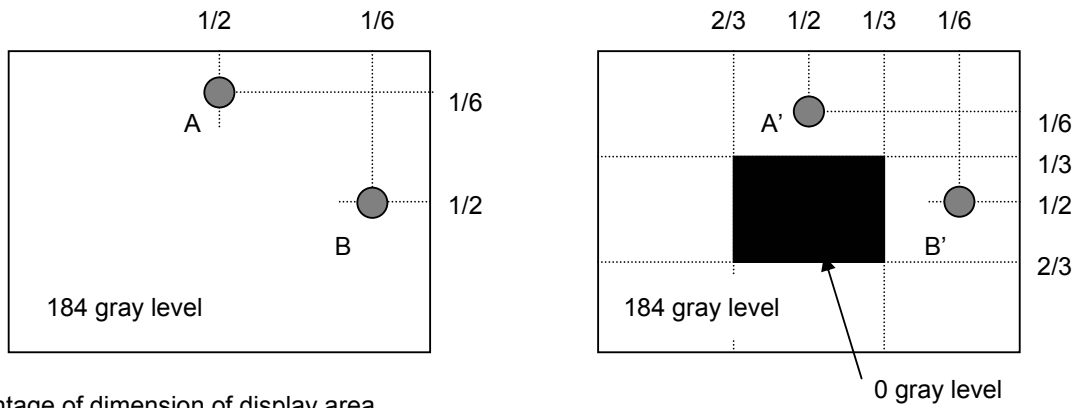

Unit: percentage of dimension of display area

$|L_A - L_{A'}| / L_A \times 100\% = 1.2\% \text{ max.}$ ,  $L_A$  and  $L_B$  are brightness at location A and B

$|L_B - L_{B'}| / L_B \times 100\% = 1.2\% \text{ max.}$ ,  $L_{A'}$  and  $L_{B'}$  are brightness at location A' and B'

## 2.2 Functional Block Diagram

The following diagram shows the functional block of 15.0 inches Color TFT-LCD Module:

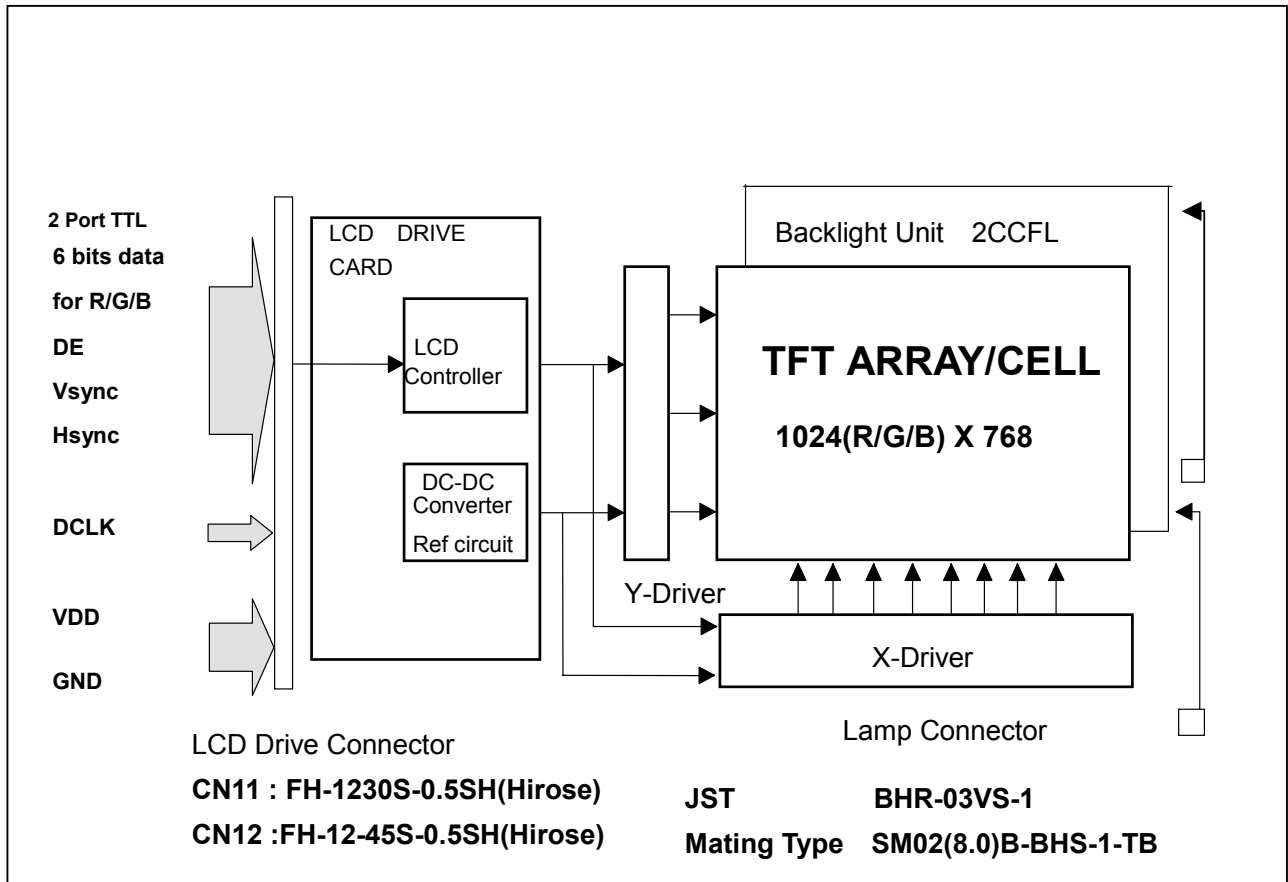



### 3.0 Absolute Maximum Ratings

Absolute maximum ratings of the module is as following:

Item	Symbol	Min	Max	Unit	Conditions
Logic/LCD Drive Voltage	VDD	-0.3	+3.6	[Volt]	
Input Voltage of Signal	Vin	-0.3	VDD+0.3	[Volt]	
CCFL Inrush current	ICFLL	-	20	[mA]	Note 1
CCFL Current	ICFL	-	8.0	[mA] rms	
CCFL Ignition Voltage	Vs	-	1,400	Vrms	Note 1
Operating Temperature	TOP	0	+50	[°C]	Note 2
Operating Humidity	HOP	20	85	[%RH]	Note 2
Storage Temperature	TST	-20	+60	[°C]	Note 2
Storage Humidity	HST	5	95	[%RH]	Note 2
Vibration			1.5 / 10-200	[G / Hz]	
Shock			50/20	[G / ms]	Half sine wave
Assured Torque at Side Mount			2.0	[kgf.cm]	
Re-screw			3	[Times]	

Note 1 : Duration = 50msec

Note 2 : Maximum Wet-Bulb should be 39°C and No condensation.

#### Wet bulb temperature chart

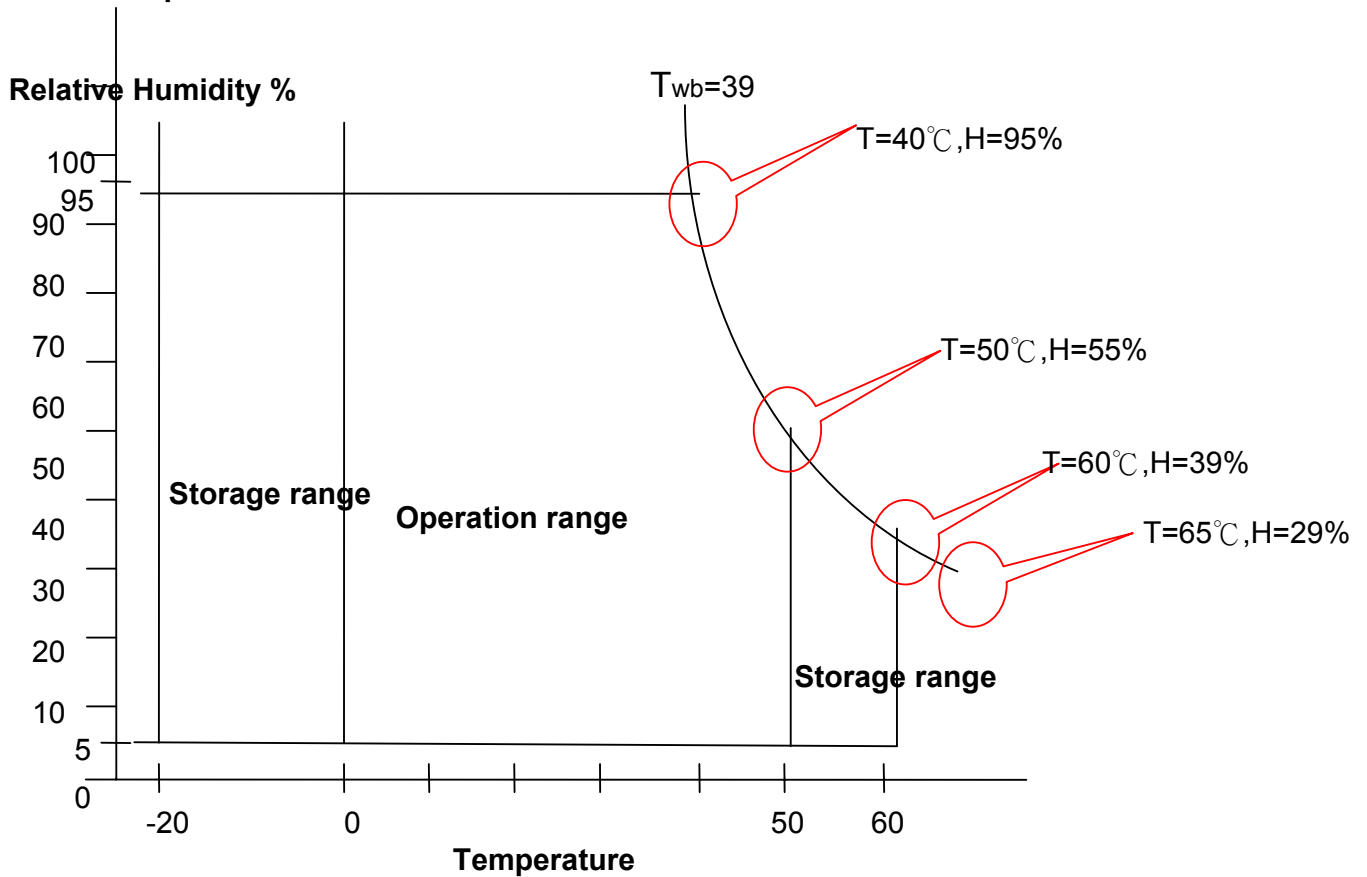

## 4.0 Optical Characteristics

The optical characteristics are measured under stable conditions at 25°C (Room Temperature):

Item	Unit	Conditions	Min.	Typ.	Max.
Viewing Angle	[degree]	Horizontal (Right)	65	75	
	[degree]	CR = 10 (Left)	65	75	
CR: Contrast Ratio	[degree]	Vertical (Upper)	60	70	
	[degree]	CR = 10 (Lower)	60	70	
Contrast ratio		Normal Direction	300	400	-
Response Time( Note 1)	[msec]	Raising Time Ton ( 10%-90% )	-	5	9
	[msec]	Falling Time Toff ( 90%-10% )	-	11	15
	[msec]	Raising + Falling	-	16	24
Color / Chromaticity Coordinates (CIE)		Red x	0.587	0.617	0.647
		Red y	0.317	0.347	0.377
		Green x	0.260	0.290	0.320
		Green y	0.563	0.593	0.623
		Blue x	0.118	0.148	0.178
		Blue y	0.070	0.100	0.130
Color Coordinates (CIE) White		White x	0.283	0.313	0.343
		White y	0.299	0.329	0.359
Brightness Uniformity	[%]		75	80	-
White Luminance at CCFL 8.0mA	[cd/m <sup>2</sup> ]		460	500	-
White Luminance at CCFL 6.5mA			410	450	-
Crosstalk ( in 75Hz)	[%]				1.2

Note 1: Definition of Response time:

The output signals of photodetector are measured when the input signals are changed from “Black” to “White” (falling time), and from “White” to “Black” (rising time), respectively. The response time interval between the 10% and 90% of amplitudes. Refer to figure as below.

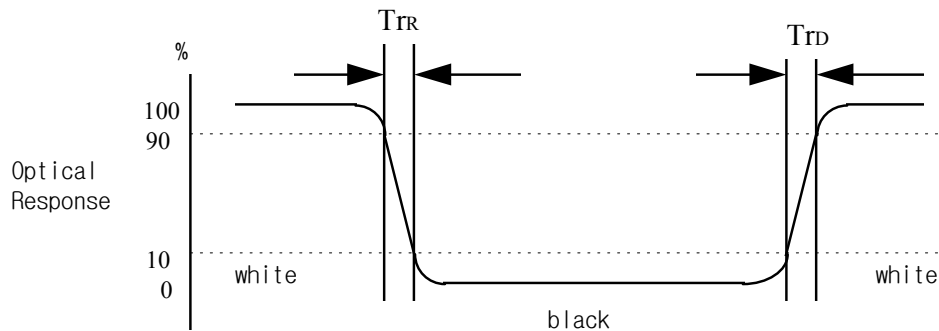

## 5.0 Signal Interface

### 5.1 Module Interface Connectors

Physical interface is described as for the connector on module.

These connectors are capable of accommodating the following signals and will be following components

<b>Connector Name</b>	Interface Connector
<b>Manufacturer</b>	Hirose or compatible
<b>Type / Part Number</b>	CN11 : FH-12-30S-0.5SH (Hirose)
	CN12 : FH-12-45S-0.5SH (Hirose)

### 5.2 Module Connector Pin Configuration

CN11 : FH-12-30S-0.5SH (Hirose)			CN12 : FH-12-45S-0.5SH (Hirose)		
Pin No.	Symbol	Description	Pin No.	Symbol	Description
1	GND	ground	1	GND	ground
2	BE5	Blue even data(MSB)	2	CLK	Data clock
3	BE4	Blue even data	3	GND	ground
4	BE3	Blue even data	4	DENA	Data enable
5	BE2	Blue even data	5	GND	ground
6	GND	ground	6	VD	Vertical sync
7	BE1	Blue even data	7	GND	ground
8	BE0	Blue even data(LSB)	8	HD	Horizontal sync
9	GND	ground	9	GND	ground
10	GND	ground	10	GND	ground
11	GND	ground	11	GND	ground
12	GE5	Green even data(MSB)	12	BO5	Blue odd data(MSB)
13	GE4	Green even data	13	BO4	Blue odd data
14	GE3	Green even data	14	BO3	Blue odd data
15	GE2	Green even data	15	BO2	Blue odd data
16	GND	ground	16	GND	ground
17	GE1	Green even data	17	BO1	Blue odd data
18	GE0	Green even data(LSB)	18	BO0	Blue odd data(LSB)
19	GND	ground	19	GND	ground
20	GND	ground	20	GND	ground
21	GND	ground	21	GND	ground
22	RE5	Red even data(MSB)	22	BO5	Green odd data(MSB)
23	RE4	Red even data	23	BO4	Green odd data
24	RE3	Red even data	24	BO3	Green odd data

25	RE2	Red even data	25	BO2	Green odd data
26	GND	ground	26	GND	ground
27	RE1	Red even data	27	BO1	Green odd data
28	RE0	Red even data(LSB)	28	BO0	Green odd data(LSB)
29	GND	ground	29	GND	ground
30	GND	ground	30	GND	ground
			31	GND	ground
			32	RO5	Red odd data(MSB)
			33	RO4	Red odd data
			34	RO3	Red odd data
			35	RO2	Red odd data
			36	GND	ground
			37	RO1	Red odd data
			38	RO0	Red odd data(LSB)
			39	GND	ground
			40	GND	ground
			41	VCC	Power input +3.3V
			42	VCC	Power input +3.3V
			43	VCC	Power input +3.3V
			44	NC	Should be open
			45	NC	Should be open

### 5.3 Backlight Connectors

<b>Connector Name / Designation</b>	For Lamp Connector
<b>Manufacturer</b>	JST or compatible
<b>Type / Part Number</b>	BHR-03VS-1
<b>Mating Type / Part Number</b>	SM02(8.0)B-BHS-1-TB

### 5.4 Backlight Connector Pin Configuration

Pin	Symbol	Description
1	HV	Lamp High Voltage
2	NC	No connection
3	LV	Ground

- ◆ Cable length: 150 +- 5 mm
- ◆ Connector-output position: right side(front view)
- ◆ Lamp assy design shall be easy for replacement and repair.

## 5.5 Signal Electrical Characteristics

Each signal characteristics are as follows;

Item	Symbol	Min	Typ	Max	Unit
LCD Drive voltage	VDD	+3.0	+3.3	+3.6	[V]
“High” input signal voltage	Vih	2.0	-	-	[V]
“Low” input signal voltage	Vil	-	-	0.8	[V]

## 5.6 Interface Timings Characteristics

Signal	Item	Symbol	MIN	TYP	MAX	Unit
DCLK	Frequency	1/TDCLK	-	32.5	40.0	MHz
	Period	TDCLK	25	30.8	-	ns
	High time	TCH	0.4	0.5	0.6	TDCLK
	Low time	TCL	0.4	0.5	0.6	TDCLK
DATA	Setup time	TDS	3	-	-	ns
	Hold time	TDH	1	-	-	ns
Data Enable	Setup time	TES	3	-	-	ns
	Hold time	TEH	1	-	-	ns
Horizontal sync	Frequency	1/TH	-	48	60	KHz
	Pulse width	THP	2	68	-	TDCLK
Horizontal Signal	Back –porch	THB	1	80	-	TDCLK
	Display period	THD	512	512	512	TDCLK
	Front-porch	THF	0	12	-	TDCLK
	H total	TH	600	672	-	
Vertical sync	Frequency	1/TV	-	60	75	Hz
	Pulse width	TVP	1	6	-	TH
Vertical Signal	Back-porch	TVB	7	29	64	TH
	Display period	TVD	768	768	768	TH
	Front-porch	TVF	1	3	-	TH
	Vsync period + Vback-porch	TVP+TVB	8	-	64	

## 5.7 Interface Timing Definition

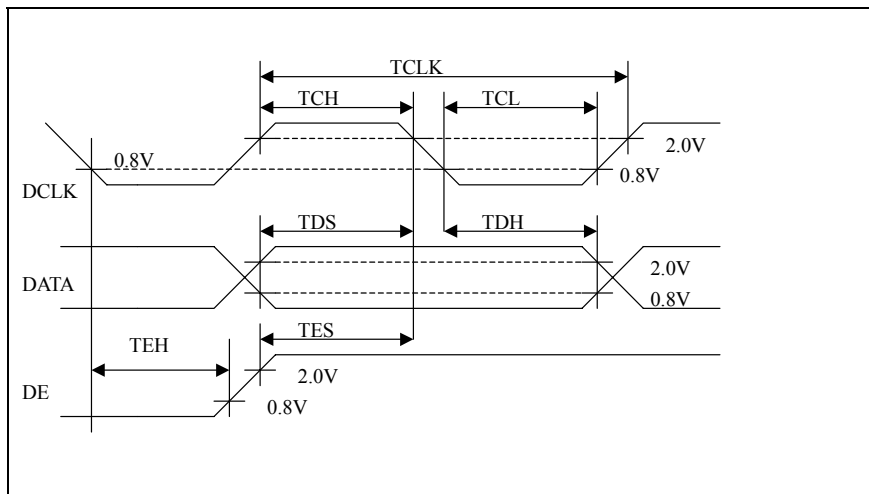
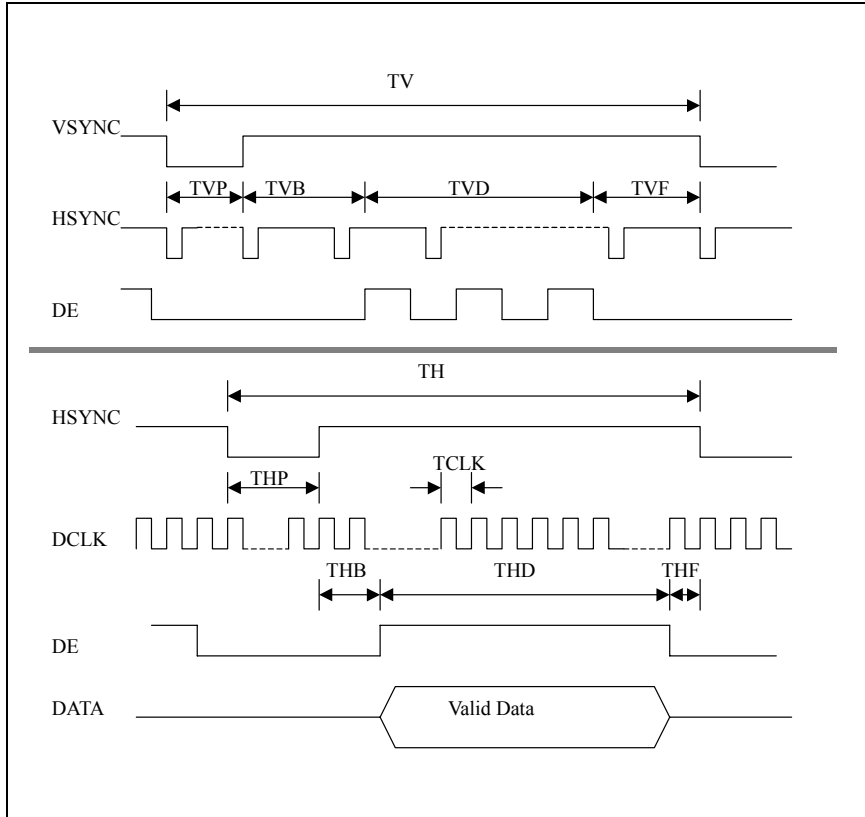

## 6.0 Pixel format image

Following figure shows the relationship of the input signals and LCD pixel format.

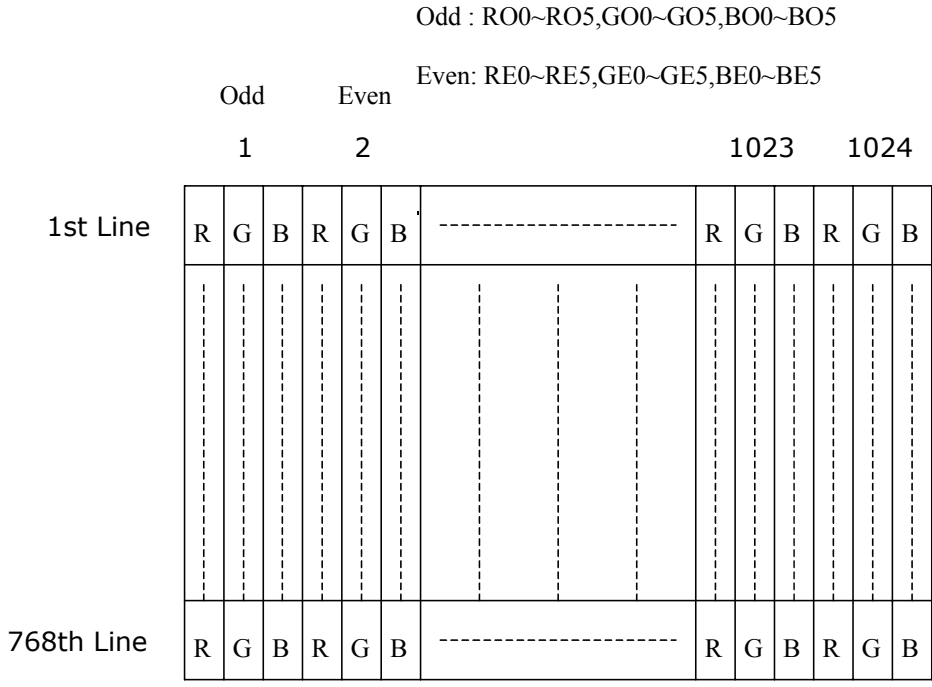

## 7.0 Power Consumption

Input power specifications are as follows;

Symbol	Parameter	Min	Typ	Max	Units	Condition
VDD	LCD Drive Voltage	3.0	3.3	3.6	[V]	
IDD	LCD Drive Current	-	600	700	[mA]	
PDD	LCD Drive power consumption	-	2.0	2.4	[Watt]	VDD=3.3v, All Black Pattern
VDDrp	Allowable LCD Drive Ripple Voltage			100	[mV] p-p	
VDDns	Allowable LCD Drive Ripple Noise			100	[mV] p-p	

## 8.0 Power ON/OFF Sequence

VDD power and lamp on/off sequence is as follows. Interface signals are also shown in the chart.

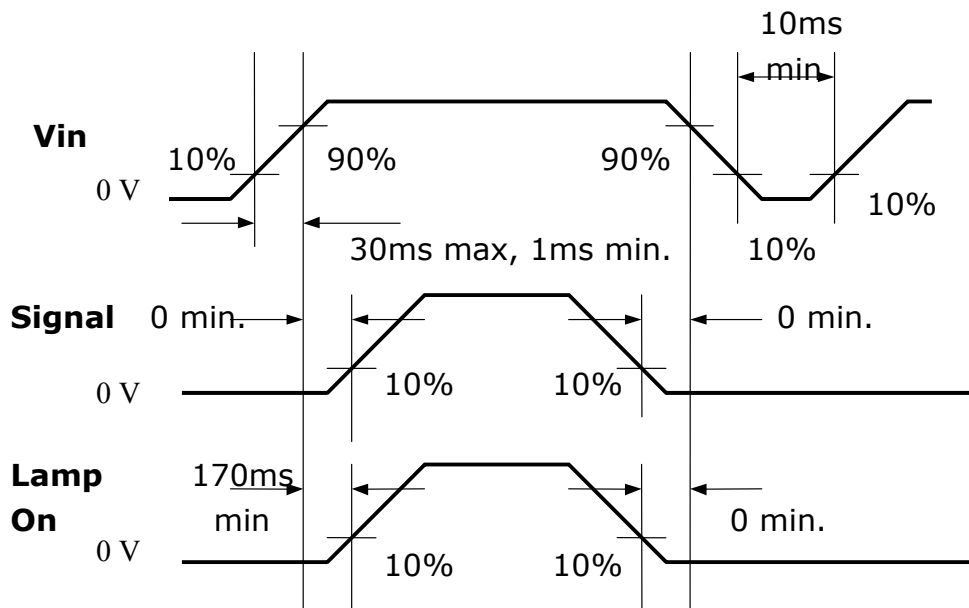



## 9.0 Backlight Characteristics

### 9.1 Signal for Lamp connector

Pin #	signal Name
1	Lamp High Voltage
2	No connection
3	Ground

### 9.2 Parameter guide line for CCFL Inverter

Symble	Parameter	Min	Typ	Max	Units	Condition
(L255)	White Luminance	410 @ 6.5mA	450@ 6.5mA 500@ 8.0mA	-	[cd/m <sup>2</sup> ]	(Ta=25°C)
IRCFL	CCFL operation range	3.0	8.0	8.5	[mA] rms	(Ta=25°C) <b>Note 5</b>
ICFL	CCFL Inrush current	-	-	20	[mA]	<b>Note 1</b>
fCFL	CCFL Frequency	40	55	60	[KHz]	(Ta=25°C) <b>Note 2</b>
ViCFL (25°C) (reference)	CCFL Ignition Voltage	1000			[Volt] rms	(Ta= 25°C) <b>Note 4</b>
ViCFL (0°C) (reference)	CCFL Ignition Voltage	1300			[Volt] rms	(Ta= 0°C) <b>Note 4</b>
VCFL	CCFL Discharge Voltage (Reference)		590	650	[Volt] rms	(Ta=25°C) <b>Note 3</b>
PCFL	CCFL Power consumption @ 8mA (excluding inverter)		9.4	10.4	[Watt]	(Ta=25°C) <b>Note 3</b>

Note 1: Duration=50 [msec]

Note 2: CCFL Frequency should be carefully determined to avoid interference between inverter and TFT LCD

Note 3: Calculator value for reference (ICFL×VCFL=PCFL)

Note 4: CCFL inverter should be able to give out a power that has a generating capacity of over 1300 voltage.  
Lamp units need 1300 voltage minimum for ignition

Note 5: CCFL life time 30,000hr under 8mA, it's defined as when the brightness is reduced by half.

To exceed 8.0mA, life time accelerate drop down and if to exceed 8.5mA has safety problem.



## 10.0 Label, Vibration, Shock, and Drop

### 10.1 Label

Unit mark is printed on a label. The label is shown as below:

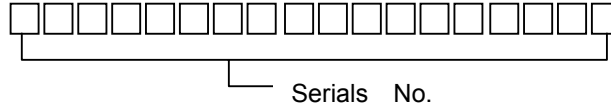
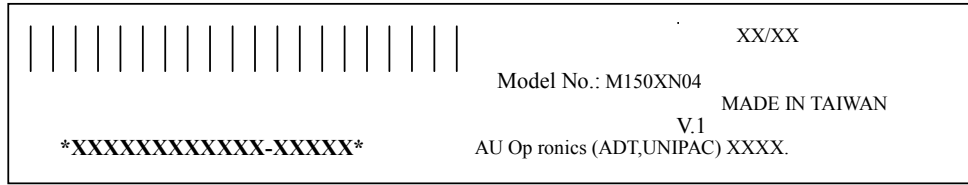

CARTON LABEL:

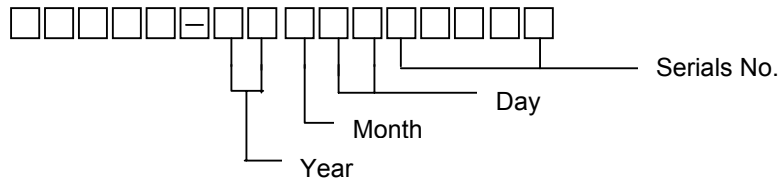
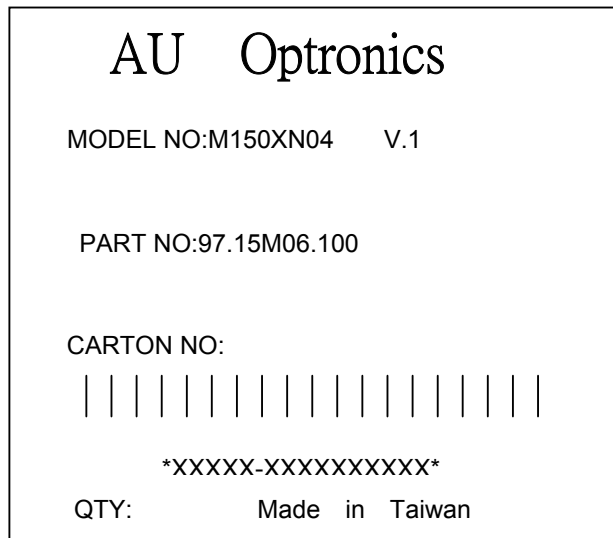

Year	Mark
1997	97
1998	98
1999	99
2000	00
2001	01
2002	02

Month	Mark	Month	Mark
1	1	7	7
2	2	8	8
3	3	9	9
4	4	10	A
5	5	11	B
6	6	12	C

### 10.2 Vibration & Shock

The module shall work error free after following vibration and shock condition. Likewise the module shall not sustain any damage after vibration and shock test.

(C) Copyright AU Optronics, Inc.

Oct. 2001 All Rights Reserved.

M150XN05-1 Ver0.1

18/27

No Reproduction and Redistribution Allowed.

### 10.2.1 Vibration Test Spec:

- Frequency: 10 - 200Hz
- Sweep: 30 Minutes each Axis (X, Y, Z)
- Acceleration: 1.5G(10~200Hz P- P)
- Test method:

<b>Acceleration (G)</b>	1.5
<b>Frequency (Hz)</b>	10~200~10
<b>Active time(min)</b>	30

### 10.2.2 Shock Test Spec:

<b>Acceleration (G) -a</b>	50
<b>Active time(ms) -b</b>	20
<b>Wave form</b>	half-sin
<b>Times</b>	1

- Direction:  $\pm X$ ,  $\pm Y$ ,  $\pm Z$

### 10.3 Drop

Package test: The drop height is defined as 60 cm.

## 11.0 Environment

The display module will meet the provision of this specification during operating condition or after storage or shipment condition specified below. Operation at 10% beyond the specified range will not cause physical damage to the unit.

### 11.1 Temperature and Humidity

#### 11.1.1 Operating Conditions

The display module operates error free, when operated under the following conditions;

Temperature	0 °C to 50 °C
Relative Humidity	20% to 85%
Wet Bulb Temperature	39.0 °C

#### 11.1.2 Shipping Conditions

The display module operates error free, after the following conditions;

Temperature	-20 °C to 60 °C
Relative Humidity	5% to 95%
Wet Bulb Temperature	39.0 °C

### 11.2 Atmospheric Pressure

The display assembly is capable of being operated without affecting its operations over the pressure range as following specified:

	Pressure	Altitude
Maximum Pressure	1040 hPa	0 m = sea level
Minimum Pressure	601 hPa	3658 m = 12,000 feet

Note: Non-operation altitude limit of this display module = 40,000 feet. = 12193 m.

### 11.3 Thermal Shock

The display module will not sustain damage after being subjected to 100 cycles of rapid temperature change. A cycle of rapid temperature change consists of varying the temperature from -20°C to 60°C, and back again.

<b>Thermal shock cycle</b>	-20 °C for 30min
	60 °C for 30min

Power is not applied during the test. After temperature cycling, the unit is placed in normal room ambient for at least 4 hours before powering on.

## 12.0 Reliability

This display module and the packaging of that will comply following standards.

### 12.1 Failure Criteria

The display assembly will be considered as failing unit when it no longer meets any of the requirements stated in this specification. Only as for maximum white luminance, following criteria is applicable.

- **Maximum white Luminance shall be 75 cd/m<sup>2</sup> or more.**

### 12.2 Failure Rate

The average failure rate of the display module (from first power-on cycle till 1,000 hours later) will not exceed 1.0%. The average failure rate of the display module from 1,000 hours until 10,000 hours will not exceed 0.70% per 1000 hours.

#### 12.2.1 Usage

The assumed usage for the above criteria is:

- 220 power-on hours per month
- 500 power on/off cycles per month
- Maximum brightness setting
- Operation to be within office environment (25<sup>0</sup>C typical)

#### 12.2.2 Component De-rating

All the components used in this device will be checked the load condition to meet the failure rate criteria.

### 12.3 CCFL Life

The assumed CCFL Life will be longer than 30,000 hours under stable condition at 25±5 °C;

Standard current at 8.0 ±0.5 mA

Definition of life: brightness becomes 50% or less than the minimum luminance value of CCFL.

### 12.4 ON/OFF Cycle

The display module will be capable of being operated over the following ON/OFF Cycles.

ON/OFF	Value	Cycle
+VDD and CCFL power	36,000	10 seconds on / 10 seconds off

## **13.0 Safety**

### **13.1 Sharp Edge Requirements**

There will be no sharp edges or corners on the display assembly that could cause injury.

### **13.2 Materials**

#### **13.2.1 Toxicity**

There will be no carcinogenic materials used anywhere in the display module. If toxic materials are used, they will be reviewed and approved by the responsible ADT Toxicologist.

#### **13.2.2 Flammability**

All components including electrical components that do not meet the flammability grade UL94-V1 in the module will complete the flammability rating exception approval process. The printed circuit board will be made from material rated 94-V1 or better. The actual UL flammability rating will be printed on the printed circuit board.

### **13.3 Capacitors**

If any polarized capacitors are used in the display assembly, provisions will be made to keep them from being inserted backwards.

### **13.4 Hazardous Voltages**

Any point exceeding 42.4 volts meets the requirement of the limited current circuit. The current through a  $2K\Omega$  resistance is less than  $0.7 \times f$  (kHz) mA.

## 14.0 Other requirements

### 14.1 Smoke Free Design

By any single failure, any smoke nor strange smell shall not be observed by the operator.

### 14.2 National Test Lab Requirement

The display module will satisfy all requirements for compliance to the following requirement:

<b>UL 1950, First Edition</b>	U.S.A. Information Technology Equipment
<b>CSA C22.2 No.950-M89</b>	Canada, Information Technology Equipment
<b>IEC 950</b>	International, Information Technology Equipment
<b>EN 60 950</b>	International, Information Processing Equipment (European Norm for IEC950)

The construction of the display module is designed to suppress EMI. When mounted into a specified host system, the system will meet the following EMI requirement:

**FCC Part 15 Class B**  
**VCCI Class 2**  
**CISPR 22, class B**  
**Taiwan CNS standard**  
**China CCIB standard**





# 15.Packing

pack form

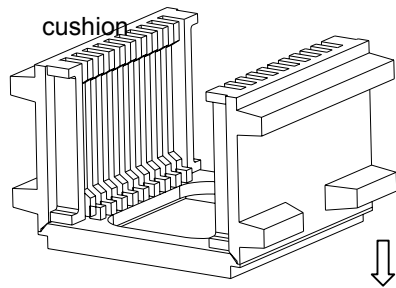
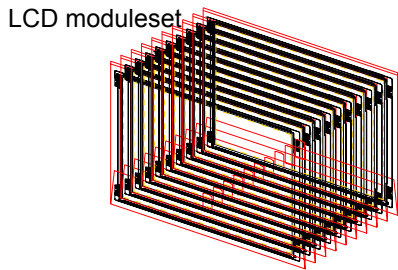
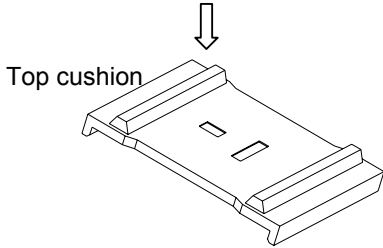
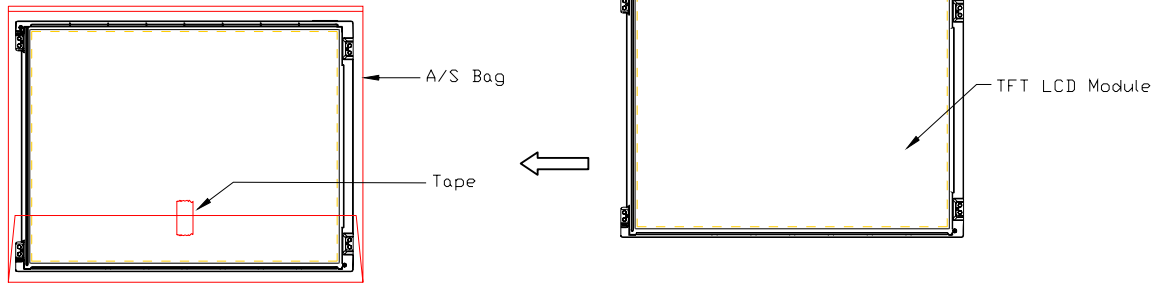

Notes:

1. Max. capacity: 10 LCD modules/carton
2. Max. weight: 12kg / carton
3. The outside dimension of carton is 490(L)mm X 390(W)mm X 360(H)mm

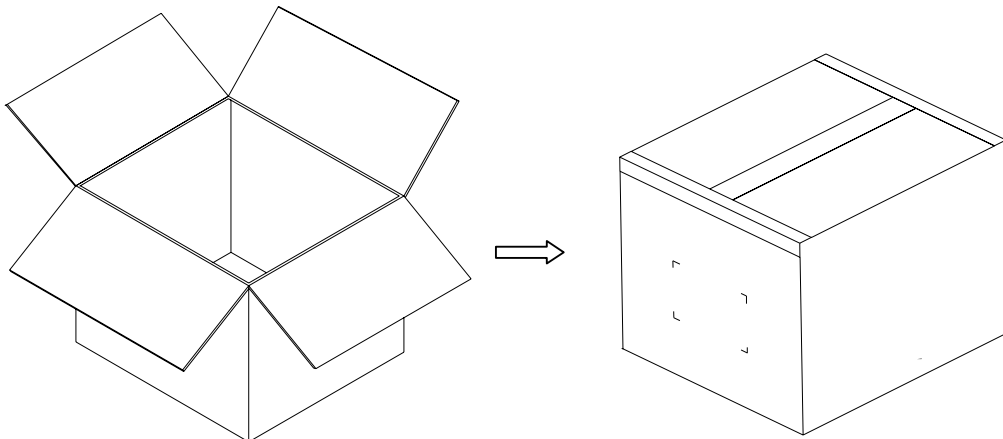

10 LCD Modules/Carton box

(C) Copyright AU Optronics, Inc.

Oct. 2001 All Rights Reserved.

No Reproduction and Redistribution Allowed.

M150XN05-1 Ver0.1

25/27

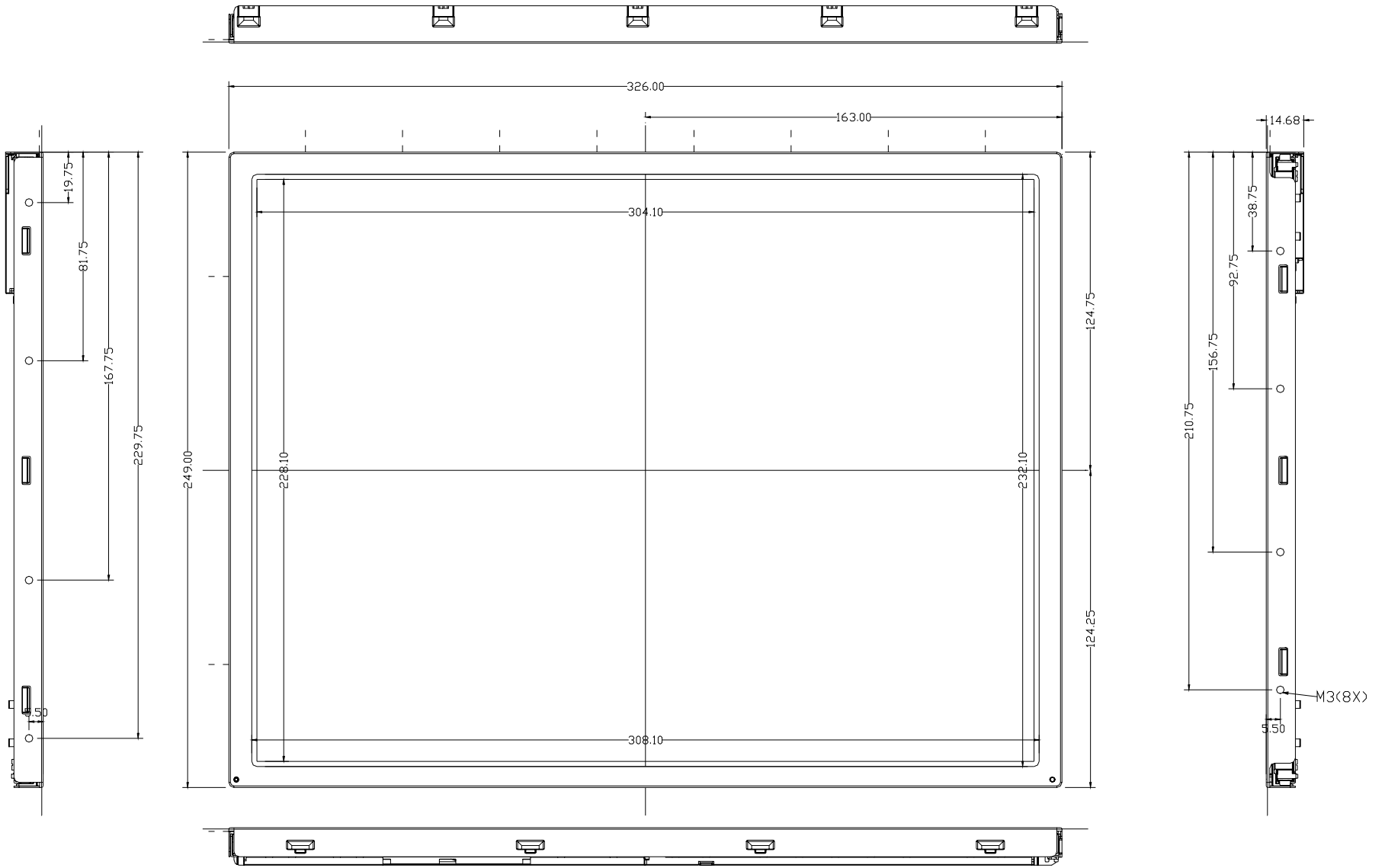

(C) Copyr

Oct. 2001

No Reproduction and Redistribution Allowed.

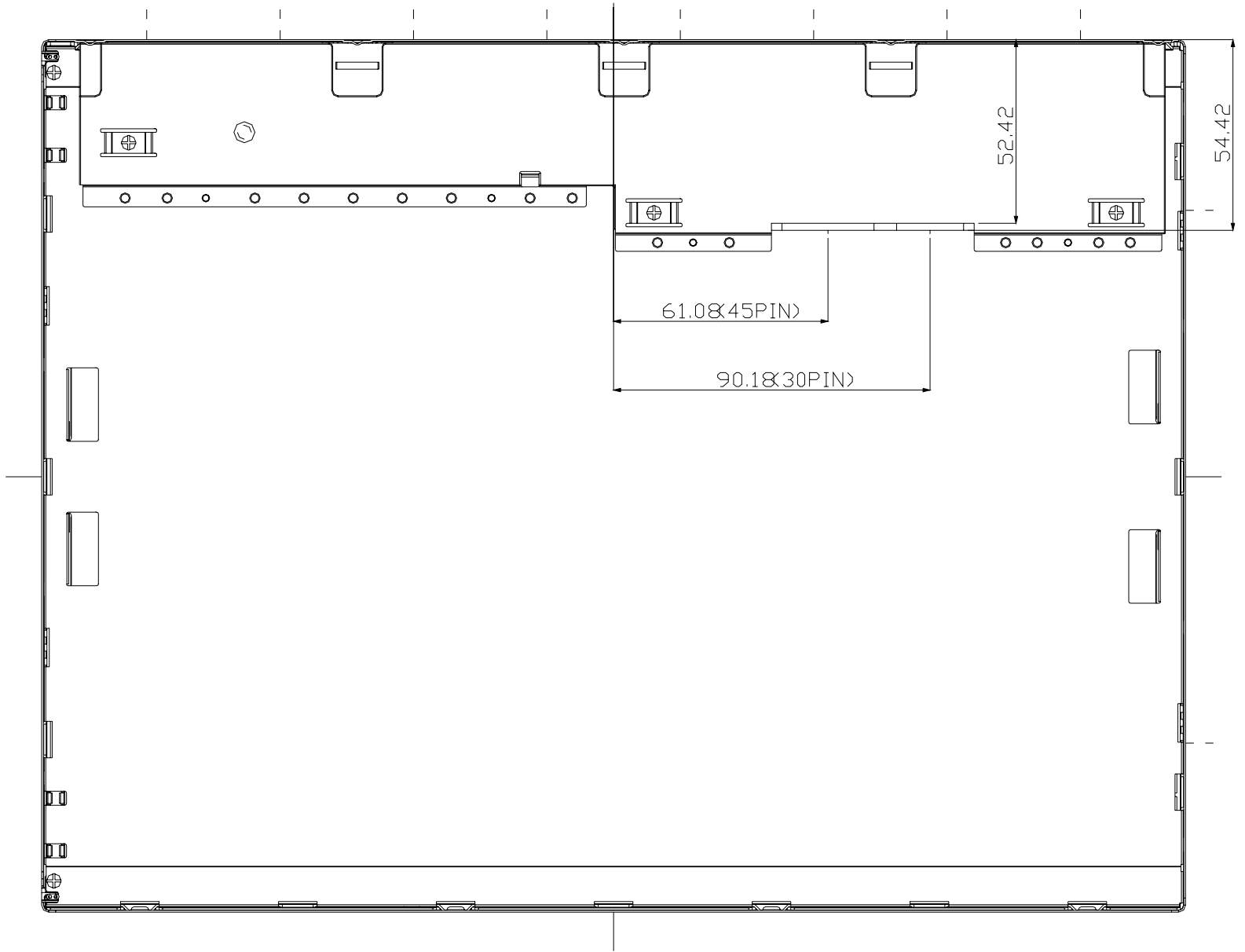

(C) C  
Oct.  
No Re.