



Product Specification

M170EG01 VB

AU OPTRONICS CORPORATION

Preliminary Specification

Final Specification

| | |
|-------------------|--------------------------|
| Module | 17.0" SXGA Color TFT-LCD |
| Model Name | M170EG01 VB |

| | |
|---|-------------|
| Customer | Date |
| _____ | _____ |
| Approved by | |
| _____ | _____ |
| Note: This Specification is subject to change without notice. | |

| | |
|----------------------------------|-------------|
| Checked & Approved by | Date |
| _____ | _____ |
| Prepared by | |
| _____ | _____ |
| AU Optronics corporation | |



Contents

| | |
|--|-----------|
| 1. Handling Precautions | 4 |
| 2. General Description | 5 |
| 2.1 Display Characteristics | 6 |
| 3. Functional Block Diagram | 11 |
| 4. Absolute Maximum Ratings | 12 |
| 4.1 Absolute Ratings of TFT LCD Module | 12 |
| 4.2 Absolute Ratings of Backlight Unit | 12 |
| 4.3 Absolute Ratings of Environment | 12 |
| 5. Electrical characteristics | 14 |
| 5.1 TFT LCD Module | 14 |
| 5.2 Backlight Unit | 15 |
| 6. Signal Characteristic | 16 |
| 6.1 Pixel Format Image | 16 |
| 6.2 The Input Data Format | 17 |
| 6.4 Interface Timing | 19 |
| 6.5 Power ON/OFF Sequence | 21 |
| 7. Connector & Pin Assignment | 22 |
| 7.1 TFT LCD Module | 22 |
| 7.2 Backlight Unit | 23 |
| 8. Reliability Test | 24 |
| 9. Shipping Label | 25 |
| 10. Mechanical Characteristics | 26 |



Record of Revision

| Version & Date | Page | Old Description | New Description | Remark |
|---------------------------|-------------|----------------------------|------------------------|---------------|
| 0.1 2005/10/05 | All | First Edition for Customer | | |
| | | | | |
| | | | | |

1. Handling Precautions

- 1) Since front polarizer is easily damaged, pay attention not to scratch it.
- 2) Be sure to turn off power supply when inserting or disconnecting from input connector.
- 3) Wipe off water drop immediately. Long contact with water may cause discoloration or spots.
- 4) When the panel surface is soiled, wipe it with absorbent cotton or other soft cloth.
- 5) Since the panel is made of glass, it may break or crack if dropped or bumped on hard surface.
- 6) Since CMOS LSI is used in this module, take care of static electricity and insure human earth when handling.
- 7) Do not open or modify the Module Assembly.
- 8) Do not press the reflector sheet at the back of the module to any directions.
- 9) In case if a Module has to be put back into the packing container slot after once it was taken out from the container, do not press the center of the CCFL reflector edge. Instead, press at the far ends of the CCFL Reflector edge softly. Otherwise the TFT Module may be damaged.
- 10) At the insertion or removal of the Signal Interface Connector, be sure not to rotate nor tilt the Interface Connector of the TFT Module.
- 11) After installation of the TFT Module into an enclosure, do not twist nor bend the TFT Module even momentary. At designing the enclosure, it should be taken into consideration that no bending/twisting forces are applied to the TFT Module from outside. Otherwise the TFT Module may be damaged.
- 12) Cold cathode fluorescent lamp in LCD contains a small amount of mercury. Please follow local ordinances or regulations for disposal.
- 13) Small amount of materials having no flammability grade is used in the LCD module. The LCD module should be supplied by power complied with requirements of Limited Power Source (IEC60950 or UL1950), or be applied exemption.
- 14) The LCD module is designed so that the CCFL in it is supplied by Limited Current Circuit (IEC60950 or UL1950). Do not connect the CCFL in Hazardous Voltage Circuit.



2. General Description

M170EG01 VB is a Color Active Matrix Liquid Crystal Display composed of a TFT-LCD panel, a driver circuit, and backlight system. The screen format is intended to support the SXGA (1280(H) x 1024(V)) screen and 16.2M colors (RGB 6-bits + FRC data). All input signals are LVDS interface compatible. Inverter card of backlight is not included. M170EG01 VB is designed for a display unit of personal computer.



2.1 Display Characteristics

The following items are characteristics summary on the table under 25 °C condition:

| Items | Unit | Specifications |
|---|----------------------|--|
| Screen Diagonal | [mm] | 432 (17.0") |
| Active Area | [mm] | 337.920(H) × 270.336(V) |
| Pixels H x V | | 1280 × 3(RGB) × 1024 |
| Pixel Pitch | [mm] | 0.264(per one triad) × 0.264 |
| Pixel Arrangement | | R.G.B. Vertical Stripe |
| Display Mode | | Normally White |
| White Luminance | [cd/m ²] | 300 (center, Typ)@7.5 mA |
| Contrast Ratio | | 500 : 1 (Typ) |
| Optical ResponseTime | [msec] | 8 (Typ) |
| Nominal Input Voltage VDD | [Volt] | +5.0 (Typ) |
| Power Consumption | [Watt] | 25.8 W (Typ) (PDD=6W, PCFL=19.8W @Lamp=7.5mA) |
| Weight | [Grams] | 1900 (Typ) |
| Physical Size (H x V x D) | [mm] | 358.5(H) x 296.5(V) x 17.0(D) (Typ) |
| Electrical Interface | | Dual Channel LVDS |
| Surface Treatment | | Anti-glare type, Hardness 3H |
| Support Color | | 16.2M colors (RGB 6-bits + FRC data) |
| Temperature Range Operating Storage (Non-Operating) | [°C] [°C] | 0 to +50 -20 to +60 |
| RoHS Compliance | | RoHS Compliance |



2.2 Optical Characteristics

The optical characteristics are measured under stable conditions at 25°C (Room Temperature):

| Item | Unit | Conditions | Min. | Typ. | Max. | Note |
|---|----------------------|--------------------------------------|----------|----------|------|------|
| Viewing Angle | [degree] | Horizontal (Right) CR = 10 (Left) | 60 60 | 70 70 | - | 1 |
| | | Vertical (Up) CR = 10 (Down) | 60 50 | 70 60 | - | |
| Luminance Uniformity | [%] | 9 Points | 75 | 80 | - | 2, 3 |
| Optical Response Time | [msec] | Rising | - | 6 | 9 | 4, 6 |
| | | Falling | - | 2 | 4 | |
| | | Rising + Falling | - | 8 | 13 | |
| Color / Chromaticity Coordinates (CIE 1931) | | Red x | 0.61 | 0.64 | 0.67 | 4 |
| | | Red y | 0.31 | 0.34 | 0.37 | |
| | | Green x | 0.26 | 0.29 | 0.32 | |
| | | Green y | 0.58 | 0.61 | 0.64 | |
| | | Blue x | 0.11 | 0.14 | 0.17 | |
| | | Blue y | 0.04 | 0.07 | 0.10 | |
| | | White x | 0.28 | 0.31 | 0.34 | |
| White y | 0.30 | 0.33 | 0.36 | | | |
| White Luminance (At CCFL= 7.5mA) | [cd/m ²] | | 240 | 300 | - | 4 |
| Contrast Ratio | | | 300 | 500 | - | 4 |
| Cross Talk (At 75Hz) | [%] | | - | - | 1.5 | 5 |
| Flicker | [dB] | | - | - | -20 | 7 |

Optical Equipment: BM-5A, BM-7, PR880, or equivalent

Note 1: Definition of viewing angle

Viewing angle is the measurement of contrast ratio ≥ 10 , at the screen center, over a 180° horizontal and 180° vertical range (off-normal viewing angles). The 180° viewing angle range is broken down as follows; 90° (θ) horizontal left and right and 90° (ϕ) vertical, high (up) and low (down). The measurement direction is typically perpendicular to the display surface with the screen rotated about its center to develop the desired measurement viewing angle.

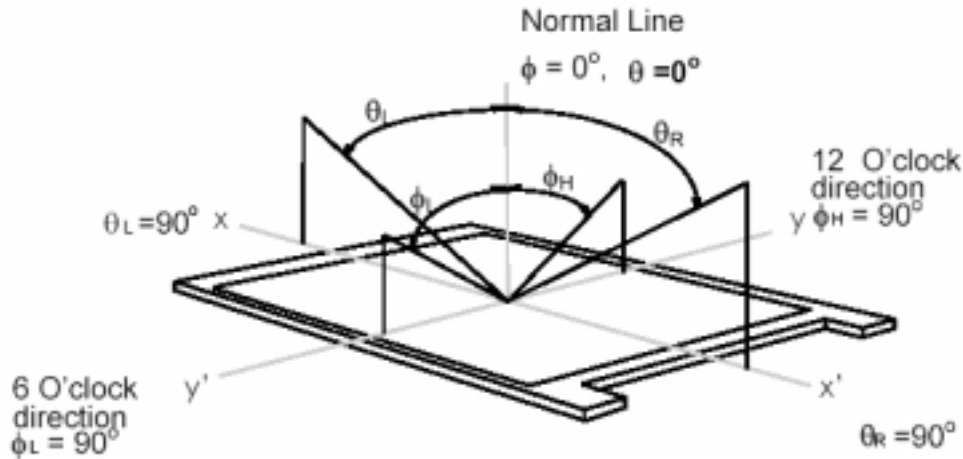

Note 2: 9 points position

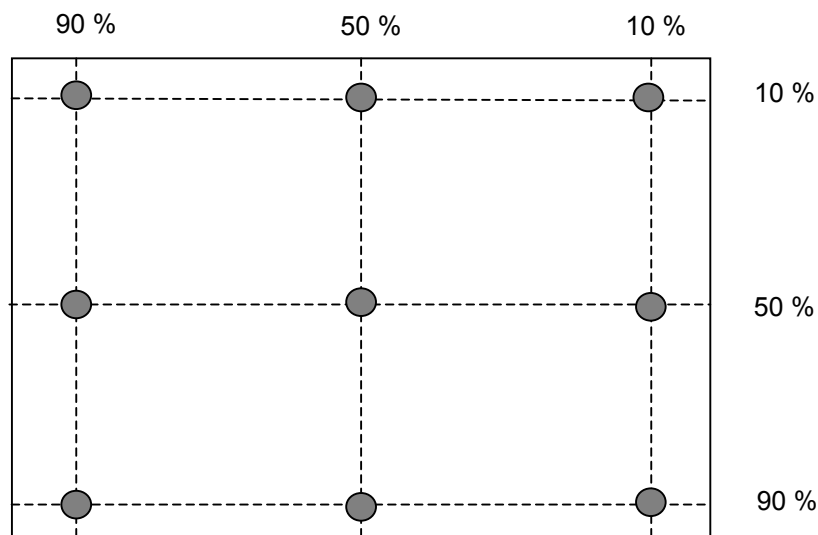

Note 3: The luminance uniformity of 9 points is defined by dividing the maximum luminance values by the minimum test point luminance

$$\delta_{w9} = \frac{\text{Minimum Luminance of 9 points}}{\text{Maximum Luminance of 9 points}}$$

Note 4: Measurement method

The LCD module should be stabilized at given temperature for 30 minutes to avoid abrupt temperature change during measuring. In order to stabilize the luminance, the measurement should be executed after lighting Backlight for 30 minutes in a stable, windless and dark room.

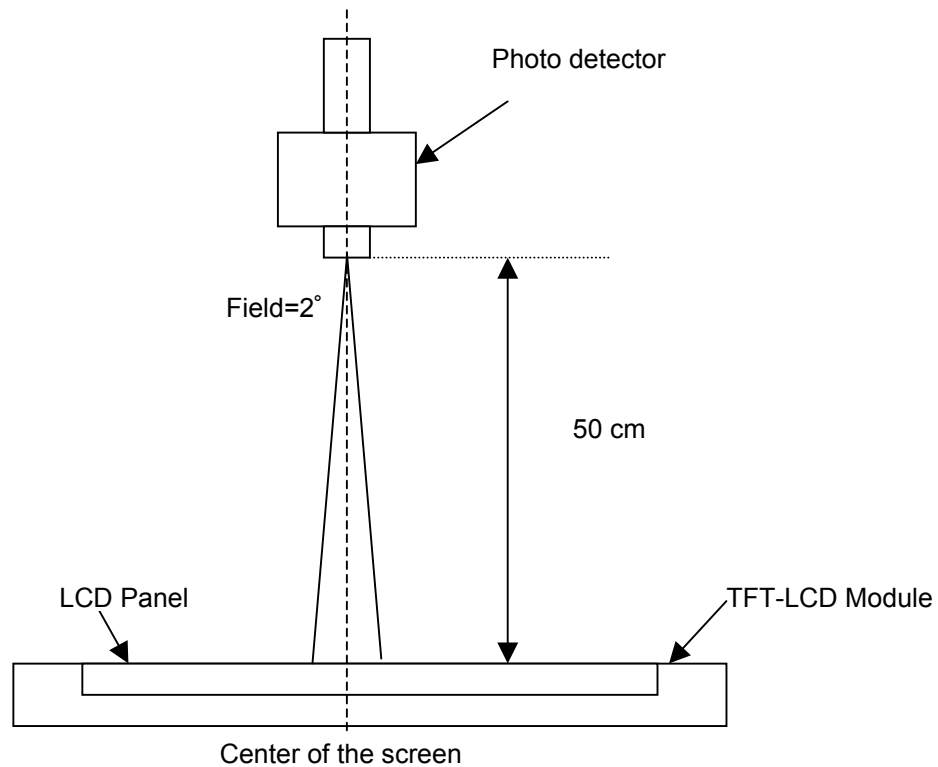

Note 5: Definition of Cross Talk (CT)

$$CT = | YB - YA | / YA \times 100 (\%)$$

Where

YA = Luminance of measured location without gray level 0 pattern (cd/m2)

YB = Luminance of measured location with gray level 0 pattern (cd/m2)



Note 6: Definition of response time:

The output signals of photo detector are measured when the input signals are changed from “Full Black” to “Full White” (rising time), and from “Full White” to “Full Black ”(falling time), respectively. The response time is interval between the 10% and 90% of amplitudes. Please refer to the figure as below.

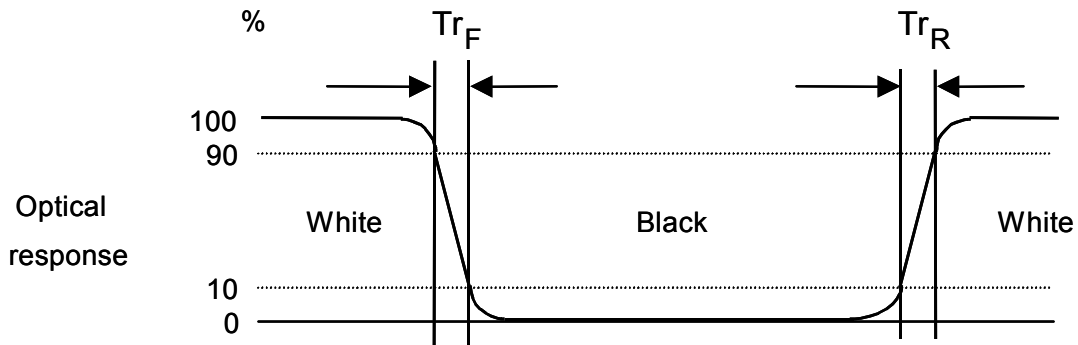

Note 7: Subchecker Pattern

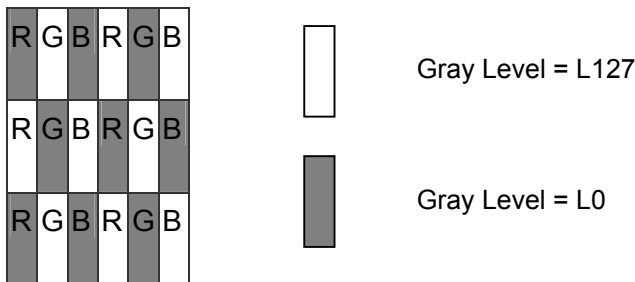

Method: Record dBV & DC value with (WESTAR)TRD-100

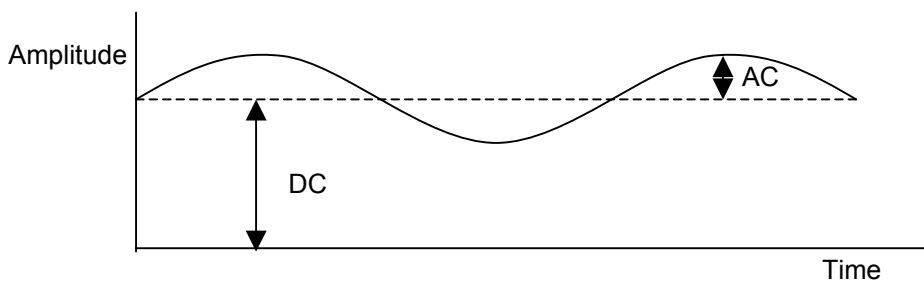

$$\text{Flicker (dB)} = 20 \log \frac{\text{AC Level(at 30 Hz)}}{\text{DC Level}}$$

3. Functional Block Diagram

The following diagram shows the functional block of the 17.0 inches Color TFT-LCD Module:

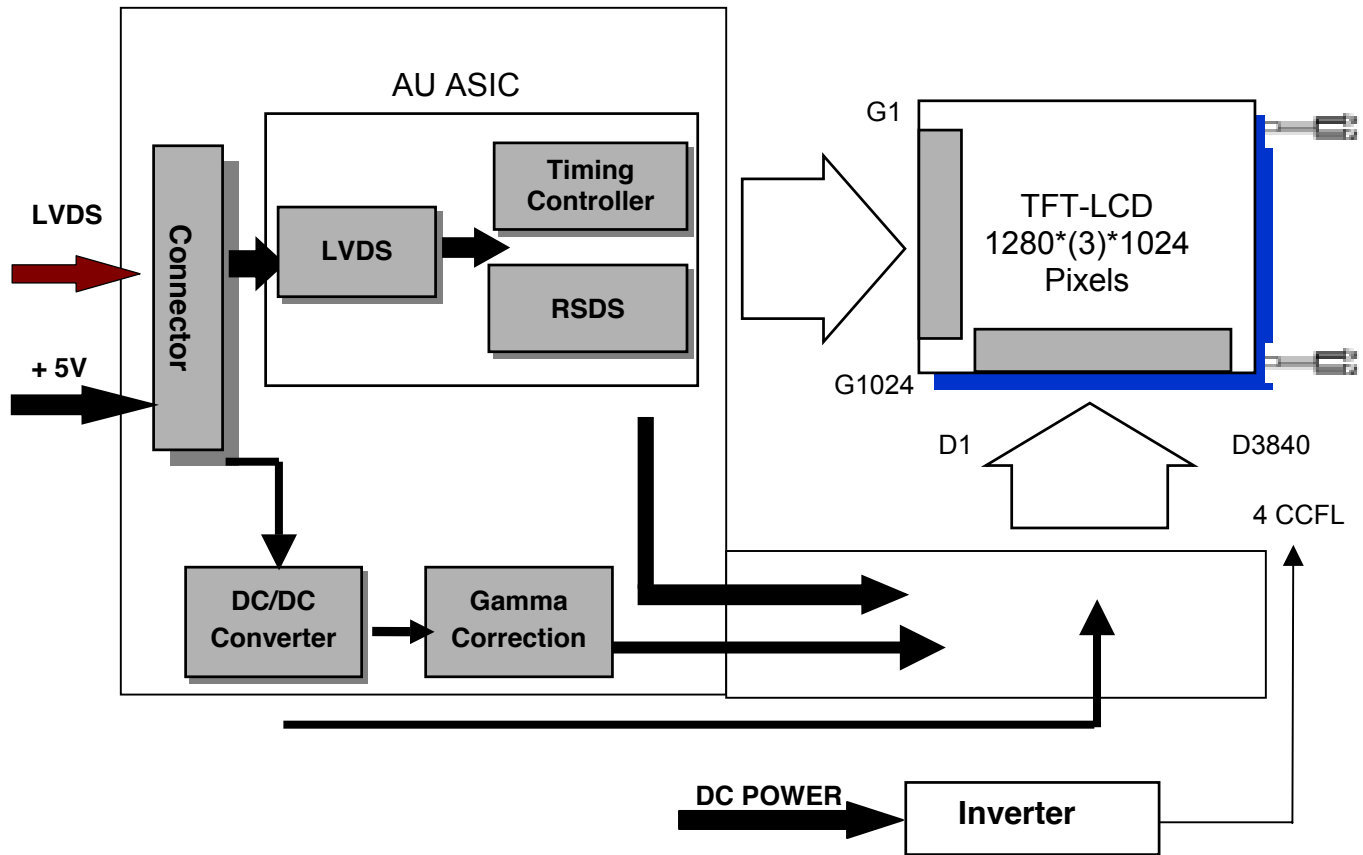



4. Absolute Maximum Ratings

Absolute maximum ratings of the module is as following:

4.1 Absolute Ratings of TFT LCD Module

| Item | Symbol | Min. | Max. | Unit | Conditions |
|-------------------------|--------|------|------|--------|------------|
| Logic/LCD Drive Voltage | VDD | -0.3 | +6 | [Volt] | Note 1, 2 |

4.2 Absolute Ratings of Backlight Unit

| Item | Symbol | Min. | Max. | Unit | Conditions |
|--------------|--------|------|------|----------|------------|
| CCFL Current | ICFL | - | 8.5 | [mA] rms | Note 1, 2 |

4.3 Absolute Ratings of Environment

| Item | Symbol | Min. | Max. | Unit | Conditions |
|-----------------------|--------|------|------|-------|------------|
| Operating Temperature | TOP | 0 | +50 | [°C] | Note 3 |
| Operation Humidity | HOP | 5 | 90 | [%RH] | |
| Storage Temperature | TST | -20 | +60 | [°C] | |
| Storage Humidity | HST | 5 | 90 | [%RH] | |

Note 1: With in $T_a = 25^\circ\text{C}$

Note 2: Permanent damage to the device may occur if exceed maximum values

Note 3: For quality performance, please refer to AUO IIS (Incoming Inspection Standard).

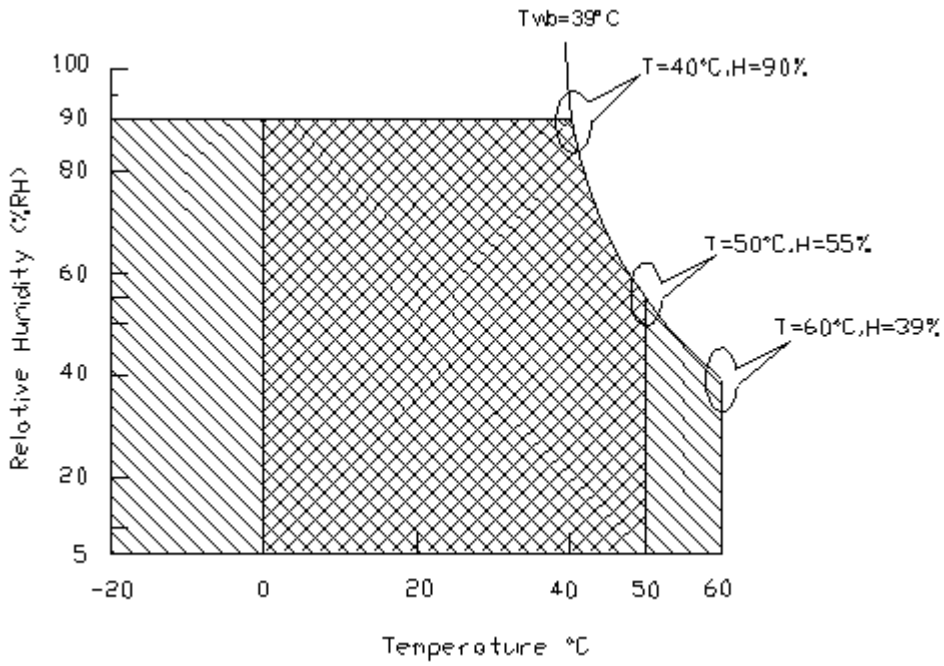

Operating Range



Storage Range

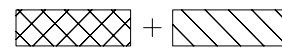

5. Electrical characteristics

5.1 TFT LCD Module

5.1.1 Power Specification

Input power specifications are as follows:

| Symbol | Parameter | Min. | Typ. | Max. | Unit | Condition |
|--------|--|------|------|------|-------------|---|
| VDD | Logic/LCD Drive Voltage | 4.5 | 5.0 | 5.5 | [Volt] | Load Capacitance 20uF |
| IDD | Input Current | - | 1.2 | 1.56 | [A] | VDD= 5.0V, All Black Pattern At 75Hz |
| PDD | VDD Power | - | 6 | 7.8 | [Watt] | VDD= 5.0V, All Black Pattern At 75Hz , Note 1 |
| IRush | Inrush Current | - | - | 3.0 | [A] | Note 2 |
| VDDrp | Allowable Logic/LCD Drive Ripple Voltage | - | - | 100 | [mV] p-p | VDD= 5.0V, All Black Pattern At 75Hz |

Note 1: The variance of VDD power consumption is $\pm 10\%$.

Note 2: Measurement conditions:

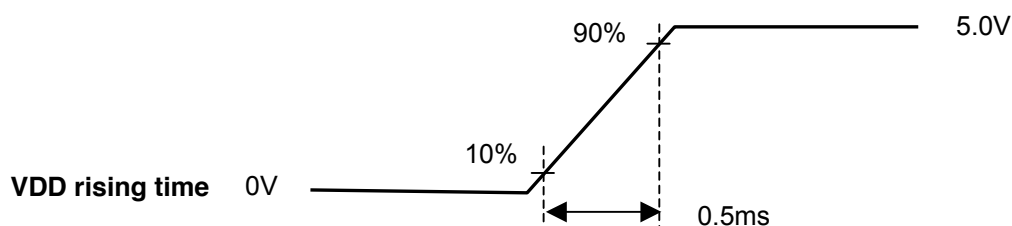
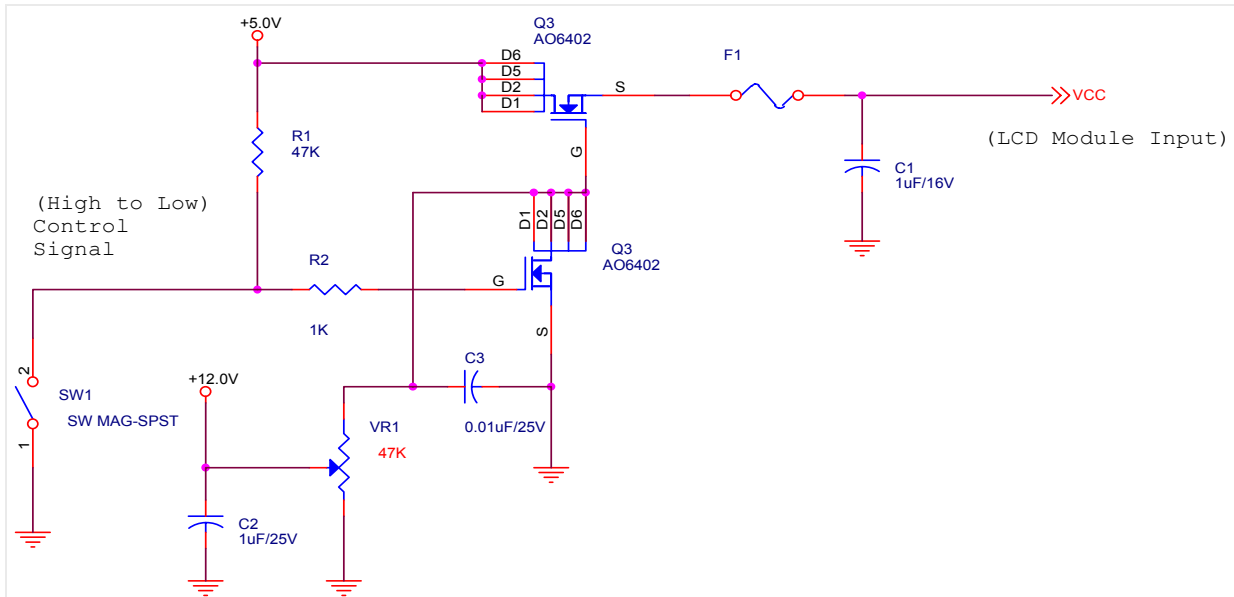

5.2 Backlight Unit

Parameter guideline for CCFL Inverter is under stable conditions at 25°C (Room Temperature):

| Parameter | Min. | Typ. | Max. | Unit | Condition |
|---------------------------------------|--------|------------------|------------------|------------|-----------|
| CCFL Standard Current(ISCFL) | 7.0 | 7.5 | 8.0 | [mA] rms | Note 2 |
| CCFL Operation Current(IRCFL) | 3.0 | 7.5 | 8.0 | [mA] rms | Note 2 |
| CCFL Frequency(FCFL) | 40 | 60 | 80 | [KHz] | Note 3,4 |
| CCFL Ignition Voltage(ViCFL, Ta= 0°C) | 1500 | - | - | [Volt] rms | Note 5 |
| CCFL Ignition Voltage(ViCF, Ta= 25°C) | 1150 | - | - | [Volt] rms | |
| CCFL Operation Voltage (VCFL) | - | 660 (@ 7.5mA) | 700 (@ 3.0mA) | [Volt] rms | Note 6 |
| CCFL Power Consumption(PCFL) | - | 19.8 | 21.8 | [Watt] | Note 6 |
| CCFL Life Time(LTCFL) | 40,000 | 50,000 | - | [Hour] | |

Note 1: Typ. are AUO recommended design points.

- *1 All of characteristics listed are measured under the condition using the AUO test inverter.
- *2 In case of using an inverter other than listed, it is recommended to check the inverter carefully. Sometimes, interfering noise stripes appear on the screen, and substandard luminance or flicker at low power may happen.
- *3 In designing an inverter, it is suggested to check safety circuit very carefully. Impedance of CCFL, for instance, becomes more than 1 [M ohm] when CCFL is damaged.
- *4 Generally, CCFL has some amount of delay time after applying kick-off voltage. It is recommended to keep on applying kick-off voltage for 1 [Sec] until discharge.
- *5 Reducing CCFL current increases CCFL discharge voltage and generally increases CCFL discharge frequency. So all the parameters of an inverter should be carefully designed so as not to produce too much leakage current from high-voltage output of the inverter.

Note 2: It should be employed the inverter which has "Duty Dimming", if IRCFL is less than 4mA.

Note 3: CCFL discharge frequency should be carefully determined to avoid interference between inverter and TFT LCD.

Note 4: The frequency range will not affect to lamp life and reliability characteristics.

Note 5: CCFL inverter should be able to give out a power that has a generating capacity of over 1,500 voltage. Lamp units need 1,500 voltage minimum for ignition.

Note 6: The variance of CCFL power consumption is ±10%. Calculator value for reference (ISCFL × VCFL × 4 = PCFL)

6. Signal Characteristic

6.1 Pixel Format Image

Following figure shows the relationship of the input signals and LCD pixel format.

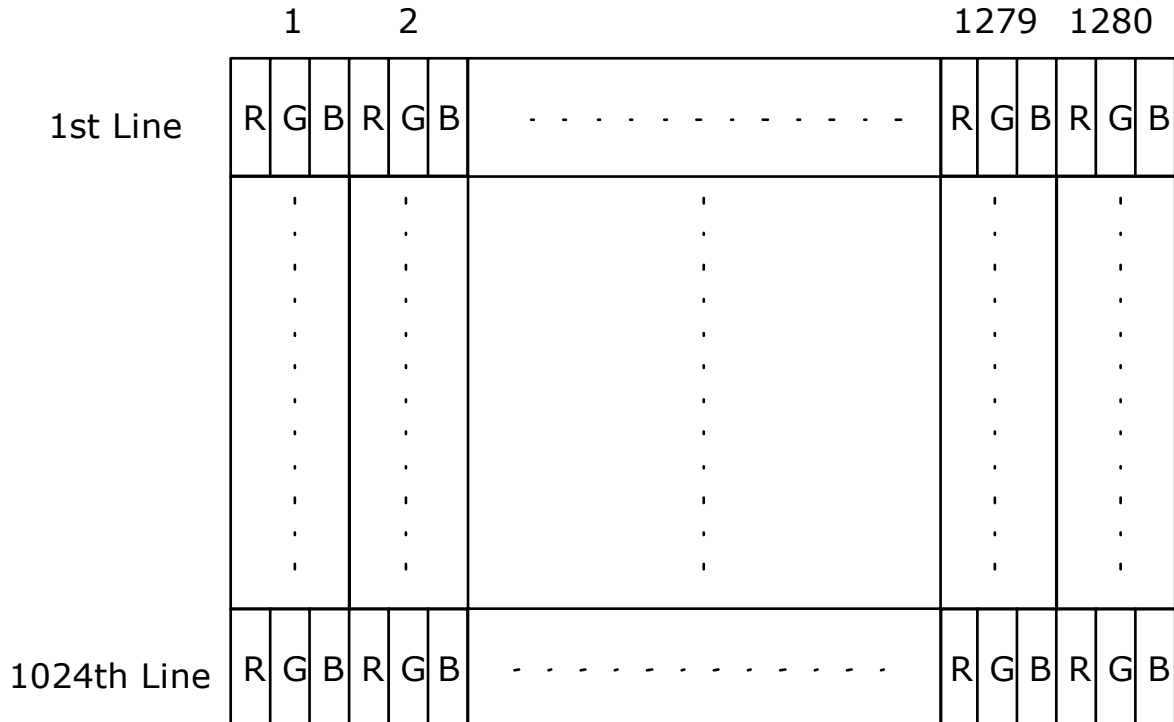

6.2 The Input Data Format

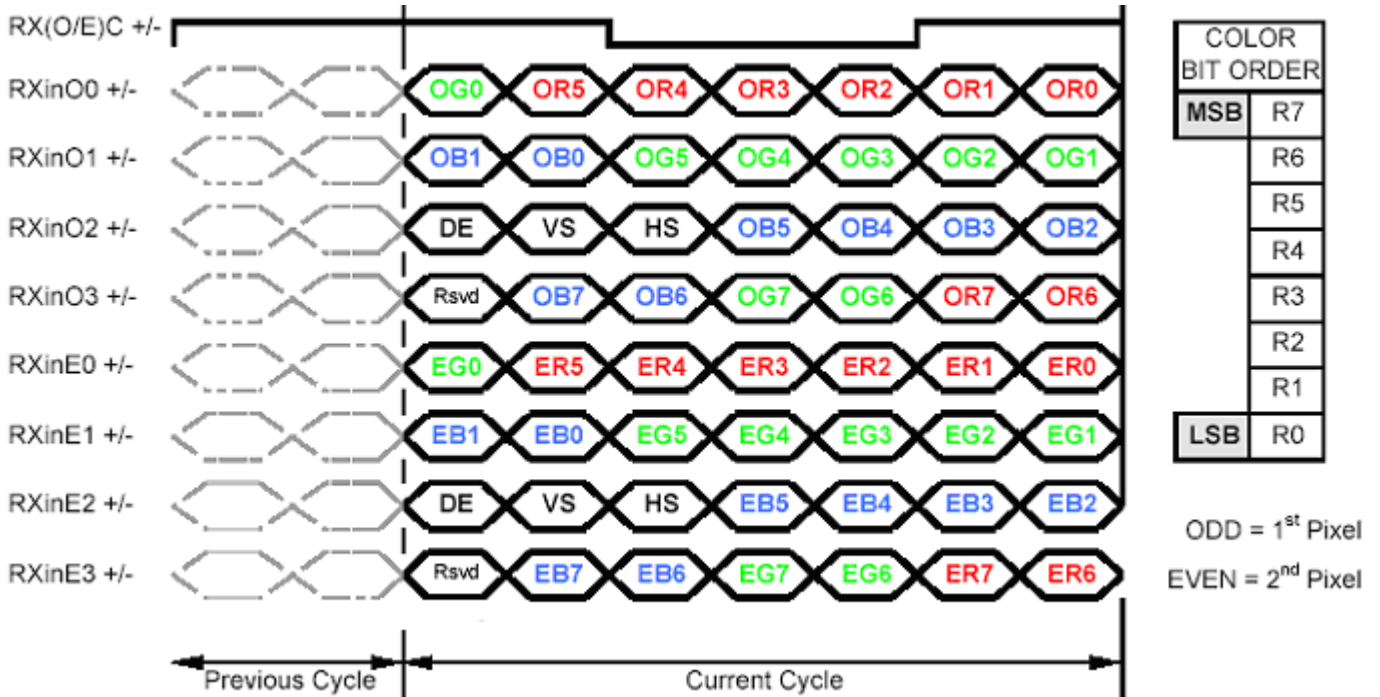

Note1: Normally, DE, VS, HS on EVEN channel are not used.

Note2: Please follow PSWG.

Note3: 8-bit in

6.3 Signal Description

The module using a pair of LVDS receiver SN75LVDS82(Texas Instruments) or compatible. LVDS is a differential signal technology for LCD interface and high speed data transfer device. Transmitter shall be SN75LVDS83(negative edge sampling) or compatible. The first LVDS port(RxOxxx) transmits odd pixels while the second LVDS port(RxExxx) transmits even pixels.

| PIN # | SIGNAL NAME | DESCRIPTION |
|-------|-------------|--|
| 1 | RxOIN0- | Negative LVDS differential data input (Odd data) |
| 2 | RxOIN0+ | Positive LVDS differential data input (Odd data) |
| 3 | RxOIN1- | Negative LVDS differential data input (Odd data) |
| 4 | RxOIN1+ | Positive LVDS differential data input (Odd data) |
| 5 | RxOIN2- | Negative LVDS differential data input (Odd data, H-Sync,V-Sync,DSPTMG) |
| 6 | RxOIN2+ | Positive LVDS differential data input (Odd data, H-Sync,V-Sync,DSPTMG) |
| 7 | VSS | Power Ground |
| 8 | RxOCLKIN- | Negative LVDS differential clock input (Odd clock) |
| 9 | RxOCLKIN+ | Positive LVDS differential clock input (Odd clock) |
| 10 | RxOIN3- | Negative LVDS differential data input (Odd data) |
| 11 | RxOIN3+ | Positive LVDS differential data input (Odd data) |
| 12 | RxEIN0- | Negative LVDS differential data input (Even data) |
| 13 | RxEIN0+ | Positive LVDS differential data input (Even data) |
| 14 | VSS | Power Ground |
| 15 | RxEIN1- | Positive LVDS differential data input (Even data) |
| 16 | RxEIN1+ | Negative LVDS differential data input (Even data) |
| 17 | VSS | Power Ground |
| 18 | RxEIN2- | Negative LVDS differential data input (Even data) |
| 19 | RxEIN2+ | Positive LVDS differential data input (Even data) |
| 20 | RxECLKIN- | Negative LVDS differential clock input (Even clock) |
| 21 | RxECLKIN+ | Positive LVDS differential clock input (Even clock) |
| 22 | RxEIN3- | Negative LVDS differential data input (Even data) |
| 23 | RxEIN3+ | Positive LVDS differential data input (Even data) |
| 24 | VSS | Power Ground |
| 25 | VSS | Power Ground |
| 26 | NC | No Connection (for AUO test) |
| 27 | VSS | Power Ground |
| 28 | VCC | +5.0V Power Supply |
| 29 | VCC | +5.0V Power Supply |
| 30 | VCC | +5.0V Power Supply |

Note1: Start from left side

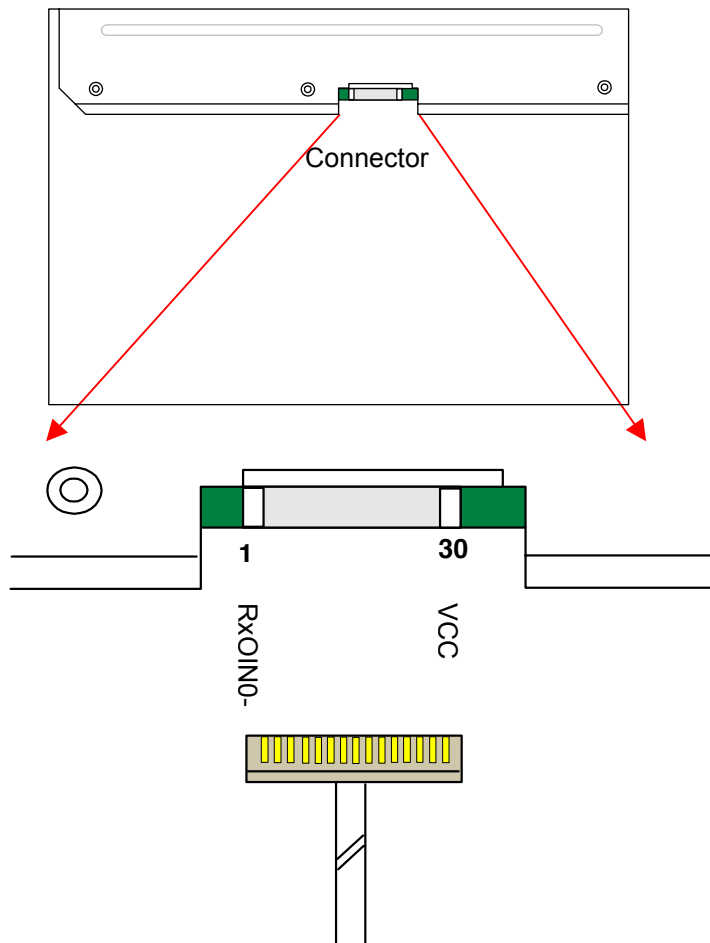

Note2: Input signals of odd and even clock shall be the same timing.

Note3: Please follow PSWG.

6.4 Interface Timing

6.4.1 Timing Characteristics

Basically, interface timings described here is not actual input timing of LCD module but output timing of SN75LVDS82DGG (Texas Instruments) or equivalent.

| Item | Symbol | Min | Typ | Max | Unit | |
|------------|--------------|----------|------|------|------|------|
| Data CLK | Tclk | 40 | 54 | 70 | MHz | |
| H-section | Period | Th | 685 | 844 | 1024 | Tclk |
| | Display Area | Tdisp(h) | 640 | 640 | 640 | Tclk |
| V-section | Period | Tv | 1036 | 1066 | 2048 | Th |
| | Display Area | Tdisp(v) | 1024 | 1024 | 1024 | Th |
| Frame Rate | F | 49 | 60 | 76 | Hz | |

Note : DE mode only

6.4.2 Timing Diagram

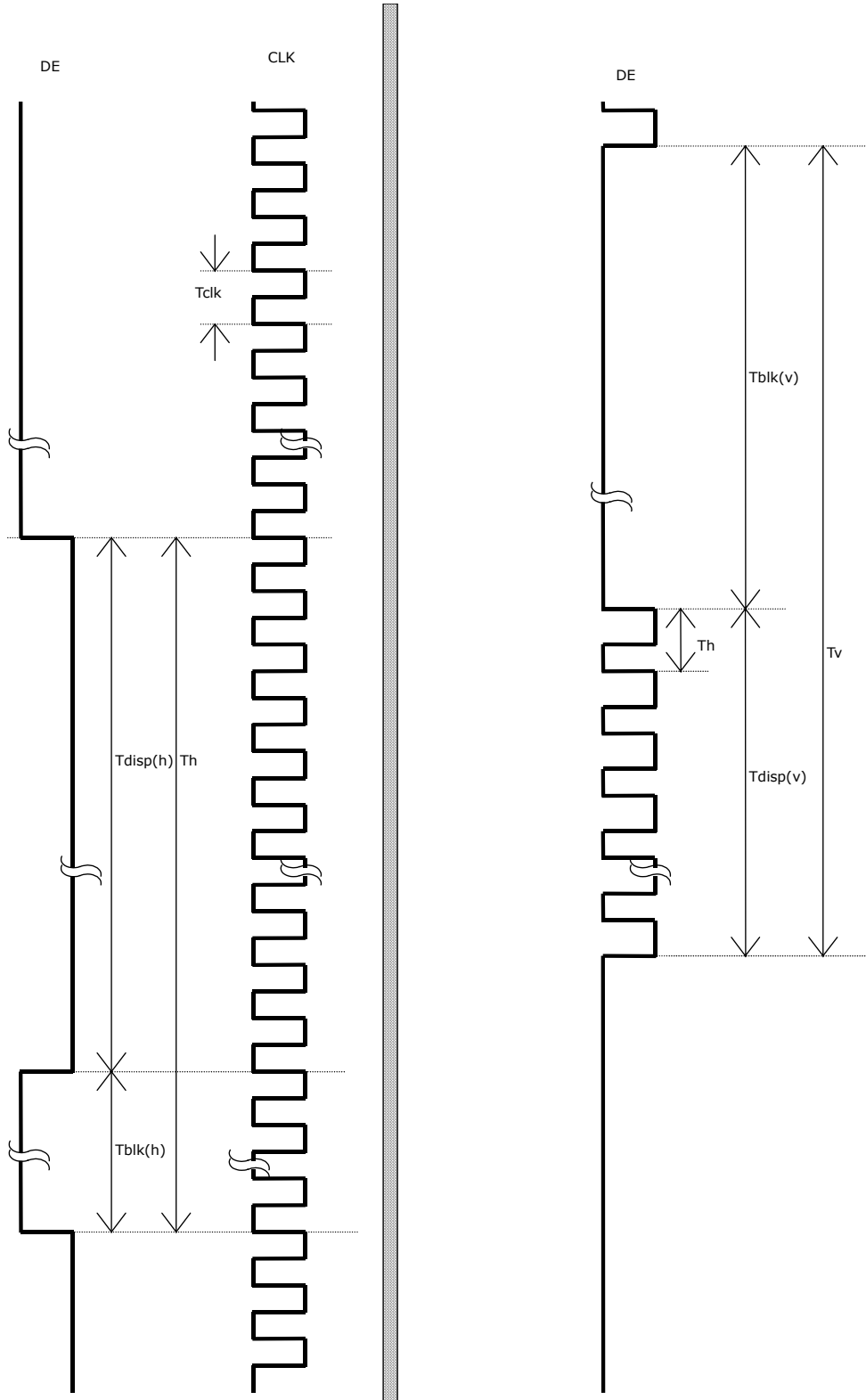

6.5 Power ON/OFF Sequence

VDD power and lamp on/off sequence is as follows. Interface signals are also shown in the chart. Signals from any system shall be Hi-Z state or low level when VDD is off.

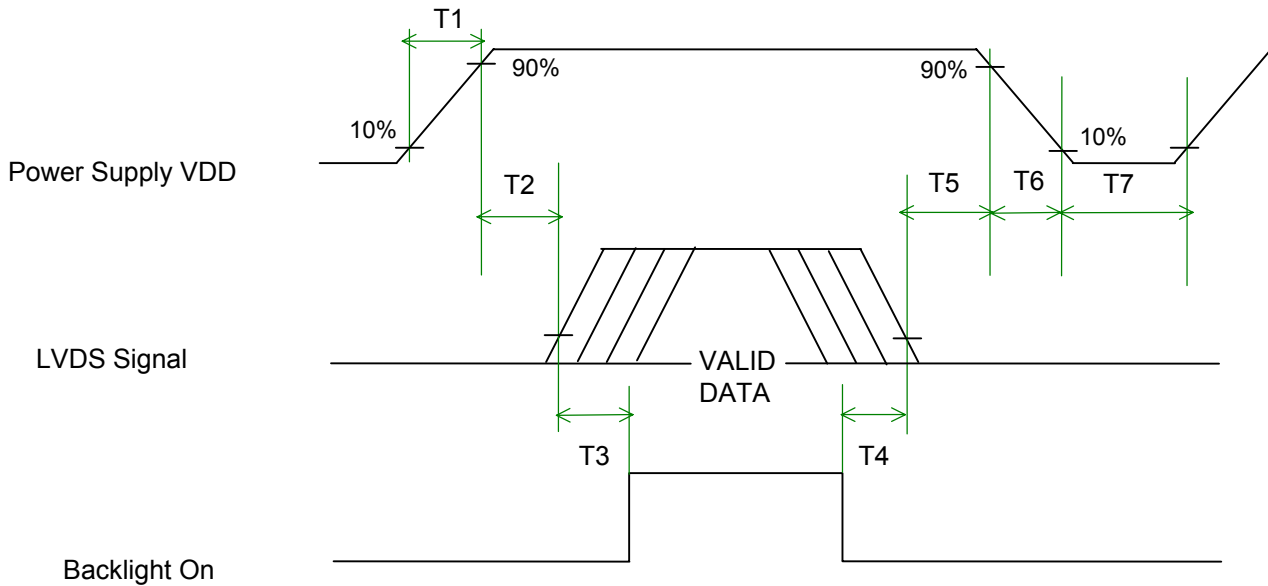

Power Sequence Timing

| Parameter | Value | | | Unit |
|-----------|-------|------|------|------|
| | Min. | Typ. | Max. | |
| T1 | 0.5 | - | 10 | [ms] |
| T2 | 0 | - | 10 | [ms] |
| T3 | 200 | - | - | [ms] |
| T4 | 100 | - | - | [ms] |
| T5 | 0 | 16 | 50 | [ms] |
| T6 | - | - | 10 | [ms] |
| T7 | 1000 | - | - | [ms] |

Note: The values of the table are follow PSWG.

7. Connector & Pin Assignment

Physical interface is described as for the connector on module. These connectors are capable of accommodating the following signals and will be following components.

7.1 TFT LCD Module

7.1.1 Connector

| | |
|------------------------------|--------------------------------------|
| Connector Name / Designation | Interface Connector / Interface card |
| Manufacturer | P2 / JAE or compatible |
| Type Part Number | AL2307-A0G1D-P / FI-XB30SSRL-HF16 |
| Mating Housing Part Number | JAE FI-X30HL |

7.1.2 Pin Assignment

| Pin# | Signal Name | Pin# | Signal Name |
|------|-------------|------|-------------|
| 1 | RxOIN0- | 2 | RxOIN0+ |
| 3 | RxOIN1- | 4 | RxOIN1+ |
| 5 | RxOIN2- | 6 | RxOIN2+ |
| 7 | VSS | 8 | RxOCLKIN- |
| 9 | RxOCLKIN+ | 10 | RxOIN3- |
| 11 | RxOIN3+ | 12 | RxEIN0- |
| 13 | RxEIN0+ | 14 | VSS |
| 15 | RxEIN1- | 16 | RxEIN1+ |
| 17 | VSS | 18 | RxEIN2- |
| 19 | RxEIN2+ | 20 | RxECLKIN- |
| 21 | RxECLKIN+ | 22 | RxEIN3- |
| 23 | RxEIN3+ | 24 | VSS |
| 25 | VSS | 26 | NC |
| 27 | VSS | 28 | VCC |
| 29 | VCC | 30 | VCC |

7.2 Backlight Unit

Physical interface is described as for the connector on module. These connectors are capable of accommodating the following signals and will be following components.

| | |
|------------------------------|---------------------------------|
| Connector Name / Designation | Lamp Connector / Backlight lamp |
| Manufacturer | JST |
| Type Part Number | BHSR-02VS-1 |
| Mating Type Part Number | SM02B-BHSS-1-TB |

7.2.1 Signal for Lamp connector

| | Connector No. | Pin No. | Input | Color | Function |
|-------|---------------|---------|-------|-------|--------------|
| Upper | CN1 | 1 | Hot1 | Pink | High Voltage |
| | | 2 | Cold1 | White | Low Voltage |
| | CN2 | 1 | Hot2 | Blue | High Voltage |
| | | 2 | Cold2 | Black | Low Voltage |

| | Connector No. | Pin No. | Input | Color | Function |
|-------|---------------|---------|-------|-------|--------------|
| Lower | CN3 | 1 | Hot1 | Pink | High Voltage |
| | | 2 | Cold1 | White | Low Voltage |
| | CN4 | 1 | Hot2 | Blue | High Voltage |
| | | 2 | Cold2 | Black | Low Voltage |



8. Reliability Test

Environment test conditions are listed as following table.

| Items | Required Condition | Note |
|-----------------------------------|--|------|
| Temperature Humidity Bias (THB) | Ta= 50°C, 80%RH, 300hours | |
| High Temperature Operation (HTO) | Ta= 50°C, 50%RH, 300hours | |
| Low Temperature Operation (LTO) | Ta= 0°C, 300hours | |
| High Temperature Storage (HTS) | Ta= 60°C, 300hours | |
| Low Temperature Storage (LTS) | Ta= -20°C, 300hours | |
| Vibration Test (Non-operation) | Acceleration: 1.5 G Wave: Random Frequency: 10 - 200 - 10 Hz Sweep: 30 Minutes each Axis (X, Y, Z) | |
| Shock Test (Non-operation) | Acceleration: 50 G Wave: Half-sine Active Time: 20 ms Direction: $\pm X$, $\pm Y$, $\pm Z$ (one time for each Axis) | |
| Drop Test | Height: 60 cm, package test | |
| Thermal Shock Test (TST) | -20°C/30min, 60°C/30min, 100 cycles | 1 |
| On/Off Test | On/10sec, Off/10sec, 30,000 cycles | |
| ESD (ElectroStatic Discharge) | Contact Discharge: $\pm 8KV$, 150pF(330 Ω) 1sec, 8 points, 25 times/ point. | 2 |
| | Air Discharge: $\pm 15KV$, 150pF(330 Ω) 1sec 8 points, 25 times/ point. | |
| Altitude Test | Operation:10,000 ft Non-Operation:30,000 ft | |

Note 1: The TFT-LCD module will not sustain damage after being subjected to 100 cycles of rapid temperature change. A cycle of rapid temperature change consists of varying the temperature from -20°C to 60°C, and back again. Power is not applied during the test. After temperature cycling, the unit is placed in normal room ambient for at least 4 hours before power on.

Note 2: According to EN61000-4-2 , ESD class B: Some performance degradation allowed. No data lost. Self-recoverable. No hardware failures.



9. Shipping Label

The shipping label format is shown as below.



10. Mechanical Characteristics

