

Product Description: T216XW01 TFT-LCD PANEL with RoHS guarantee			
AUO Model Name: T216XW01 V2			
Customer Part No/Project Name:			
Customer Signature	Date	AUO	2009/03/02
		Approved By: PM Director / Frank Hsu	
		Reviewed By: RD Director / Eugene CC Chen	
		Reviewed By: Project Leader / Sarah Ke	
		Prepared By: PM / Marcus Lai	



Product Specifications

**21.6" WXGA Color TFT-LCD Module
Model Name: T216XW01 V2**

**(*) Preliminary Specifications
() Final Specifications**

Contents

No	ITEM
	COVER
	CONTENTS
	RECORD OF REVISIONS
1	GENERAL DESCRIPTION
2	ABSOLUTE MAXIMUM RATINGS
3	ELECTRICAL SPECIFICATIONS
3-1	ELECTRICAL CHARACTERISTICS
3-2	INTERFACE CONNECTIONS
3-3	SIGNAL TIMING SPECIFICATIONS
3-4	SIGNAL TIMING WAVEFORMS
3-5	COLOR INPUT DATA REFERENCE
3-6	POWER SEQUENCE for LCD
4	OPTICAL SPECIFICATIONS
5	MECHANICAL CHARACTERISTICS
5-1	FRONT VIEW
5-2	REAR VIEW
6	RELIABILITY
7	INTERNATIONAL STANDARDS
7-1	SAFETY
7-2	EMC
7-3	GREEN
8	PACKING
8-1	PACKING INSTRUCTION
8-2	SHIPPING LABEL
8-3	CARTON LABEL
9	PRECAUTIONS
9-1	MOUNTING PRECAUTIONS
9-2	OPERATING PRECAUTIONS
9-3	ELECTROSTATIC DISCHARGE CONTROL
9-4	PRECAUTIONS FOR STRONG LIGHT EXPOSURE
9-5	STORAGE
9-6	HANDLING PRECAUTIONS FOR PROTECTION FILM

Record Revision



Version	Date	No	Old Description	New Description	Remark
0.0	2009/03/02			First Draft	

1. General Description

This specification applies to the 21.6 inch Color TFT-LCD Module T216XW01. This LCD module has a TFT active matrix type liquid crystal panel with 1,366x768 pixels, and the diagonal size is 21.6 inches. This module supports 1,366x768 XGA-WIDE mode (Non-interlace).

Each pixel is divided into Red, Green and Blue sub-pixels or dots which are arranged in vertical stripes. Gray scale or the brightness of the sub-pixel color is determined with an 8-bit gray scale signal for each dot.

The T216XW01 has been designed to apply to 8-bit and 1 channel LVDS interface method. It is intended to support displays where high brightness, wide viewing angle, high color saturation, and high color depth are very important.

This module is not equipped with inverter board for backlight.

* General Information

Item	Specification	Unit	Note
Active Screen Size	21.6	Inch	
Display Area	477.417 (H) x 268.416 (V)	mm	
Outline Dimension	523 (H) x 315 (V) x 29 (D)	mm	w/o Inverter
Resolution	1,366 x 768	pixel	
Pixel Pitch	0.3495	mm	
Pixel Arrangement	RGB vertical stripe		
Display mode	Normally Black		
Display Colors	16.7M (8-bit for R,G,B)	color	
Typical White Luminance	350 @ 9.5 mA	[cd/m ²]	
Surface Treatment	AG, Haze=11%, 3H		
Green	RoHS compliance		

2. Absolute Maximum Ratings

The following are maximum values which, if exceeded, may cause faulty operation or damage to the unit.

Item	Symbol	Min	Max	Unit	Note
Logic/LCD Drive Voltage	Vdd	-0.3	6	[Volt]	1
Input Voltage of Signal	Vin	-0.3	3.6	[Volt]	1
Operating Temperature	TOP	0	+50	[°C]	2
Operating Humidity	HOP	10	90	[%RH]	2
Storage Temperature	TST	-20	+60	[°C]	2
Storage Humidity	HST	10	90	[%RH]	2

Note

1, Duration = 50 msec

2, Maximum Wet-Bulb should be 39°C and no condensation. The relative humidity must not exceed 90% non-condensing at temperatures of 40°C or less. At temperatures greater than 40°C, the wet bulb temperature must not exceed 39°C.

3, Surface temperature is measured at 50°C Dry condition

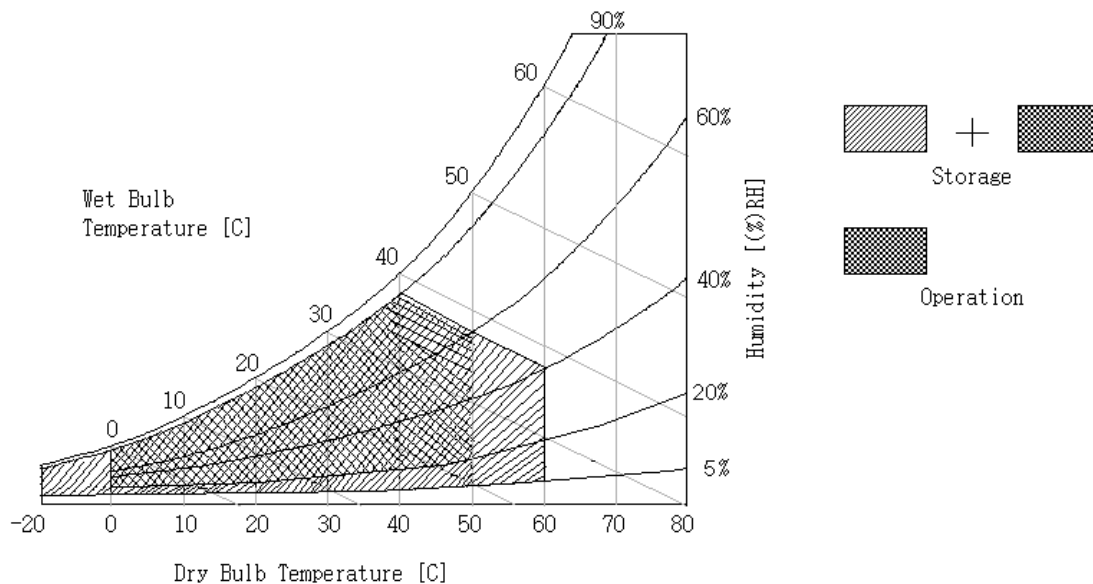

3. Electrical Specification

The T216XW01 requires two power inputs. One is employed to power the LCD electronics and to drive the TFT array and liquid crystal. An inverter typically generates the second input, which powers the CCFL.

3-1 Electrical Characteristics

Parameter		Symbol	Values			Unit	Notes
			Min	Typ	Max		
LCD	Power Supply Input Voltage	V _{CC}	4.5	5.0	5.5	V _{dc}	1
	Power Supply Input Current	I _{CC}	-	0.8	1.0	A	2
	Power Consumption	P _c	-	4.0	5.0	Watt	2
	Inrush Current	I _{RUSH}	-	-	3	A _{peak}	3
LVDS Interface	Differential Input High Threshold Voltage	V _{TH}	-	-	100	mV	4
	Differential Input Low Threshold Voltage	V _{Tl}	-100	-	-	mV	4
	Common Input Voltage	V _{CIM}	0.6	1.25	1.8	V	4
CMOS Interface	Input High Threshold Voltage	V _{IH} (High)	2.0	3.3	3.6	V _{dc}	
	Input Low Threshold Voltage	V _{IL} (Low)	0	-	0.8	V _{dc}	
Life Time			50,000	-	-		5,6,7,8

Note :

1. The ripple voltage should be controlled under 10% of V_{CC}
2. V_{CC}=5.0V, $f_v = 60\text{Hz}$, f_{CLK}=81.5Mhz , 25°C , Test Pattern : White Pattern
3. Measurement condition:

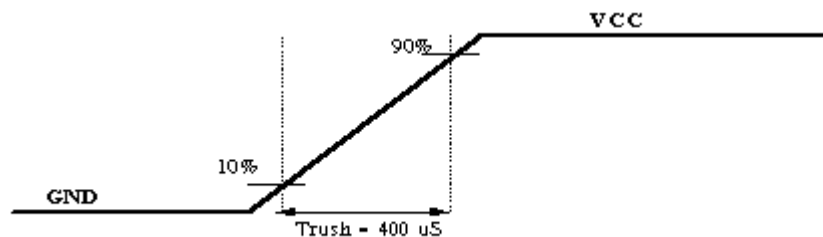

4. $V_{CIM} = 1.25V$

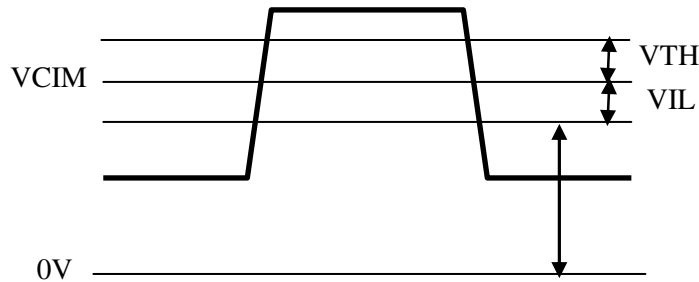

5. Take the life time and brightness for example, the performance of the lamp in LCD panel is extremely influenced by the characteristics of the DC-AC Inverter. All the parameters of the inverter should be carefully designed to avoid producing too much leakage current from high-voltage output of the inverter. Please make sure unwanted lighting caused by the mismatch of the lamp and the inverter (no lighting, flicker, etc) never occurs. After confirmation, the LCD panel should be operated in the same condition as installed in your instrument.
6. Do not attach a conducting tape to lamp connecting wire. If the lamp wire attach to conducting tape, the TFT-LCD Module has a low luminance and the inverter has abnormal action because leakage current occurs between lamp wire and conducting tape.
7. The relative humidity must not exceed 80% non-condensing at temperatures of $40^{\circ}C$ or less. At temperatures greater than $40^{\circ}C$, the wet bulb temperature must not exceed $39^{\circ}C$. When operate at low temperatures, the brightness of CCFL will drop and the life time of CCFL will be reduced.
8. Specified values are for a single lamp only which is aligned horizontally. The lifetime is defined as the time which luminance of the lamp is 50% compared to its original value.

[Operating condition: Continuous operating at $T_a = 25 \pm 2^{\circ}C$]

3-2 Interface Connections

3-2-1 LCD connector (CN1): Starconn 093G30-B0001A-1

Pin No	Symbol	Description	Note
1	Reserved	Open	AUO internal test pin
2	Reserved	Open	AUO internal test pin
3	Reserved	Open	AUO internal test pin
4	GND	Ground	
5	Rx0-	LVDS Channel 0 [Polarity: Negative]	
6	Rx0+	LVDS Channel 0 [Polarity: Positive]	
7	GND	Ground	
8	Rx1-	LVDS Channel 1 [Polarity: Negative]	
9	Rx1+	LVDS Channel 1 [Polarity: Positive]	
10	GND	Ground	
11	Rx2-	LVDS Channel 2 [Polarity: Negative]	
12	Rx2+	LVDS Channel 2 [Polarity: Positive]	
13	GND	Ground	
14	RXCLK-	LVDS Clock [Polarity: Negative]	
15	RXCLK+	LVDS Clock [Polarity: Positive]	
16	GND	Ground	
17	Rx3-	LVDS Channel 3 [Polarity: Negative]	
18	Rx3+	LVDS Channel 3 [Polarity: Positive]	
19	GND	Ground	
20	Reserved	Open	AUO internal test pin
21	LVDS Option*	Low for JEIDA, High/Open for NS	
22	Reserved	Open	
23	GND	Ground	
24	GND	Ground	
25	GND	Ground	
26	Vdd (+5V)	5V, DC, Regulated	
27	Vdd (+5V)	5V, DC, Regulated	
28	Vdd (+5V)	5V, DC, Regulated	
29	Vdd (+5V)	5V, DC, Regulated	
30	Vdd (+5V)	5V, DC, Regulated	

Note :

- 1, All GND (ground) pins should be connected together and should also be connected to the LCD's metal frame.
- 2, All Vcc (power input) pins should be connected together.

* LVDS Option = L (GND) → JETDA Format

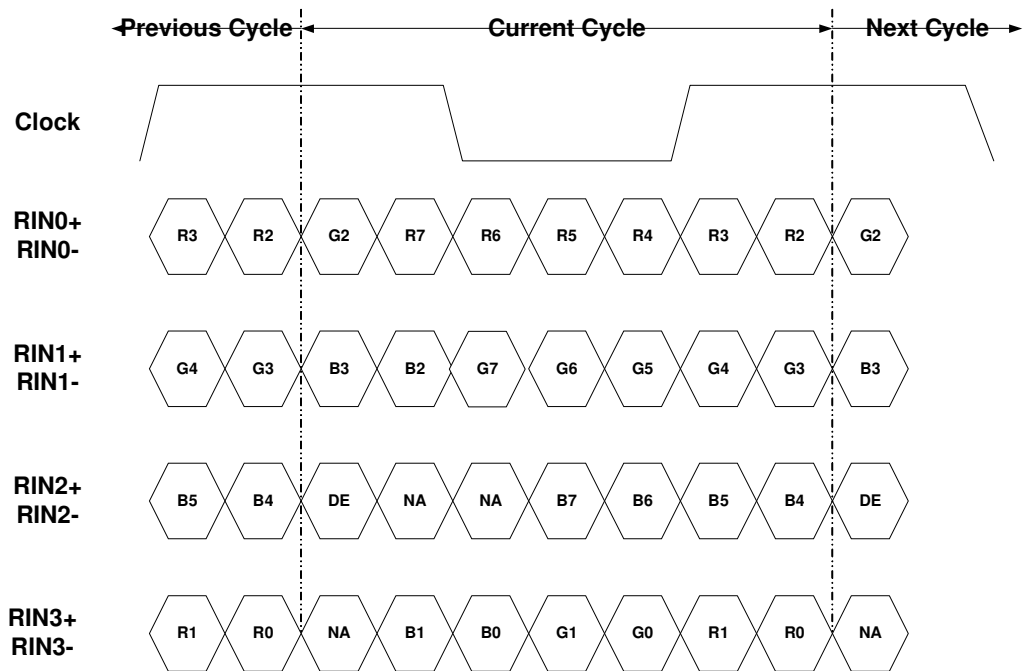

* LVDS Option = H (3.3V) or N.C. → NS Format

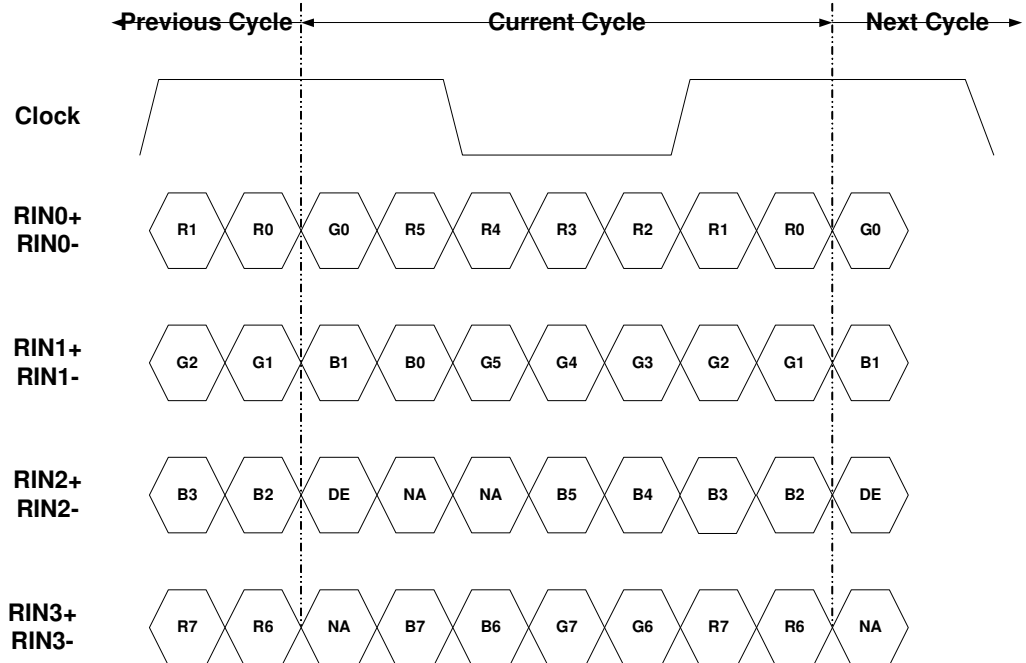

3-2-2 Backlight Electrical Specification

Description		Min	Typ	Max	Unit	Condition/Note	
1	Operating Voltage Vo	1060.2	1178	1295.8	Vrms	1. Dimming range is set 100% 2. Base on lamp specification, for each lamp need to be applied at least minimum operating voltage to ensure each lamp can be normally worked!	
2	Operating Current Io	8.0	9.5	10	mArms	1. Dimming range is set 100% 2. Base on lamp specification, for each lamp need to be applied at least minimum operating current to ensure each lamp can be normally worked!	
3	BL Total Power Dissipation PBL		30	36	Watt	1. Dimming range is set 100%. 2. In order to get typical light out, the backlight need to be applied typical power. 3. Input power of JIG BD is about 75 W (typ.) by AUO's measurement!	
4	Striking Voltage	At 0°C	1860	2060	-	Vrms	1. Base on lamp specification, to ensure each lamp can be normally ignited, need to apply at least minimum striking voltage to each lamp
		At 25°C	1550	1750	-		
5	Striking Time Ts	1000	-	1500	msec	1. To ensure each lamp can be normally ignited, each lamp need to be applied at least minimum striking voltage during minimum striking time.	
6	Operating Frequency fo	-	58	-	kHz	1. Operating frequency is set by customers. 2. Need to double confirm display quality.(*)	
.7	PWM Operating Frequency F_PWM	140	180	240	Hz	1. PWM frequency is set by customers. 2. Need to double confirm display quality.(*)	
8	PWM Dimming Duty Ratio D_PWM	10	-	100	%	Note 2. Note 3. Duty ratio definition.	
9	Lamp Type	U type					
10	Number of Lamps	3			pcs		

Note :

1, Ta=25±5°C, Turn on for 45minutes

2, When PWM dimming ratio is operated within recommend value, backlight can be ensured that there is no flicker and uniformity issue and display quality of panel can be normally display! When PWM dimming ration is operated less than recommend value, backlight need to be double confirmed display quality. LIPS need to be double confirmed feedback signal and all protection function!

3, Duty ratio definition:

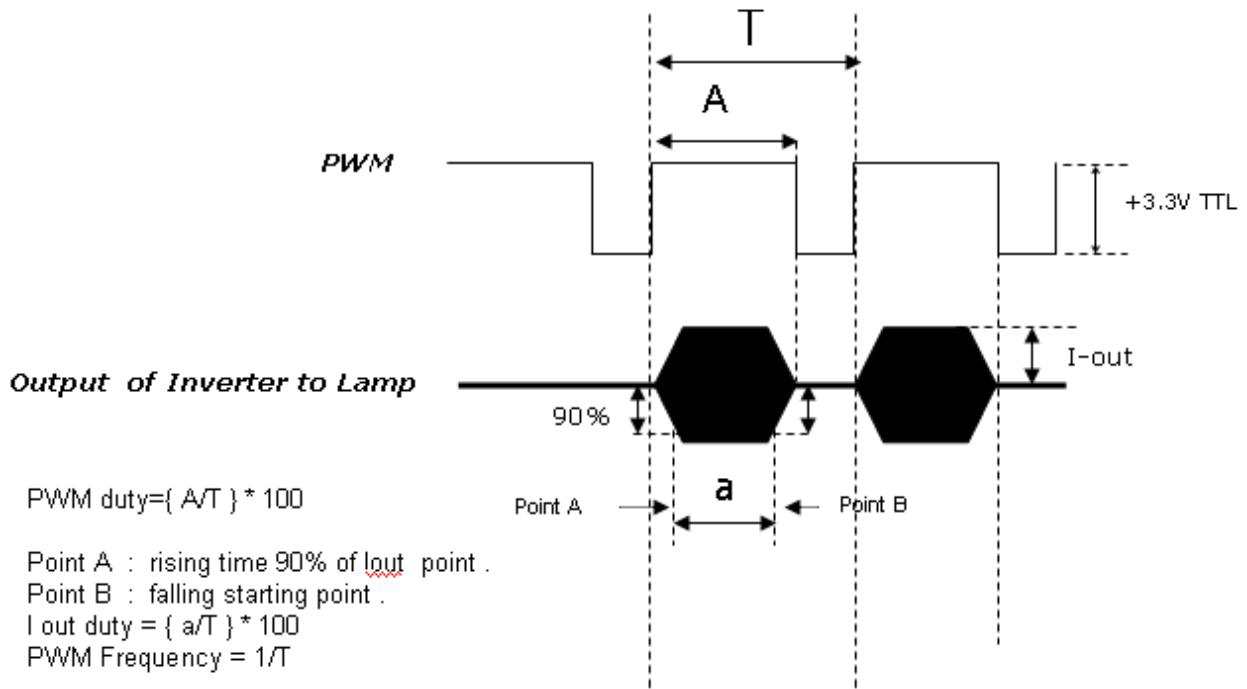

3-2-3 Lamp specification

	Description		Min	Typ	Max	Unit	Note
1	Lamp voltage	V_{lamp}	1060.2	1178	1295.8	Vrms	At $I_{lamp}=12.5mA$
2	Lamp current	I_{lamp}	8.0	9.5	10	mArms	
3	Lamp frequency	f_{lamp}	40	55	80	kHz	
4	Striking voltage	At 25°C	-	-	1550	Vrms	
		At 0°C	-	-	1860	Vrms	
5	Delayed discharge time	T_{delay}	-	-	1000	msec	
6	Life time		50K	50K	-	hour	
7	Unsymmetrical ratio		-	-	10%	-	Note 2
8	Crest factor (C.F)		$\sqrt{2} - 10\%$	$\sqrt{2}$	$\sqrt{2} + 10\%$	-	

Note

1, The above characteristics are measured under the conditions:

Ambient temperature: 25±2°C ,

Relative Humidity: 65±20%RH.

2. Please light on the lamp with symmetrical voltage and current waveform (unsymmetrical ratio is less than 10%, crest factor within $\sqrt{2} \pm 10\%$).

3-2-4 Input Interface for LIPS board

CN1: EL7H001ZZ2 (Manufactured by JAE)

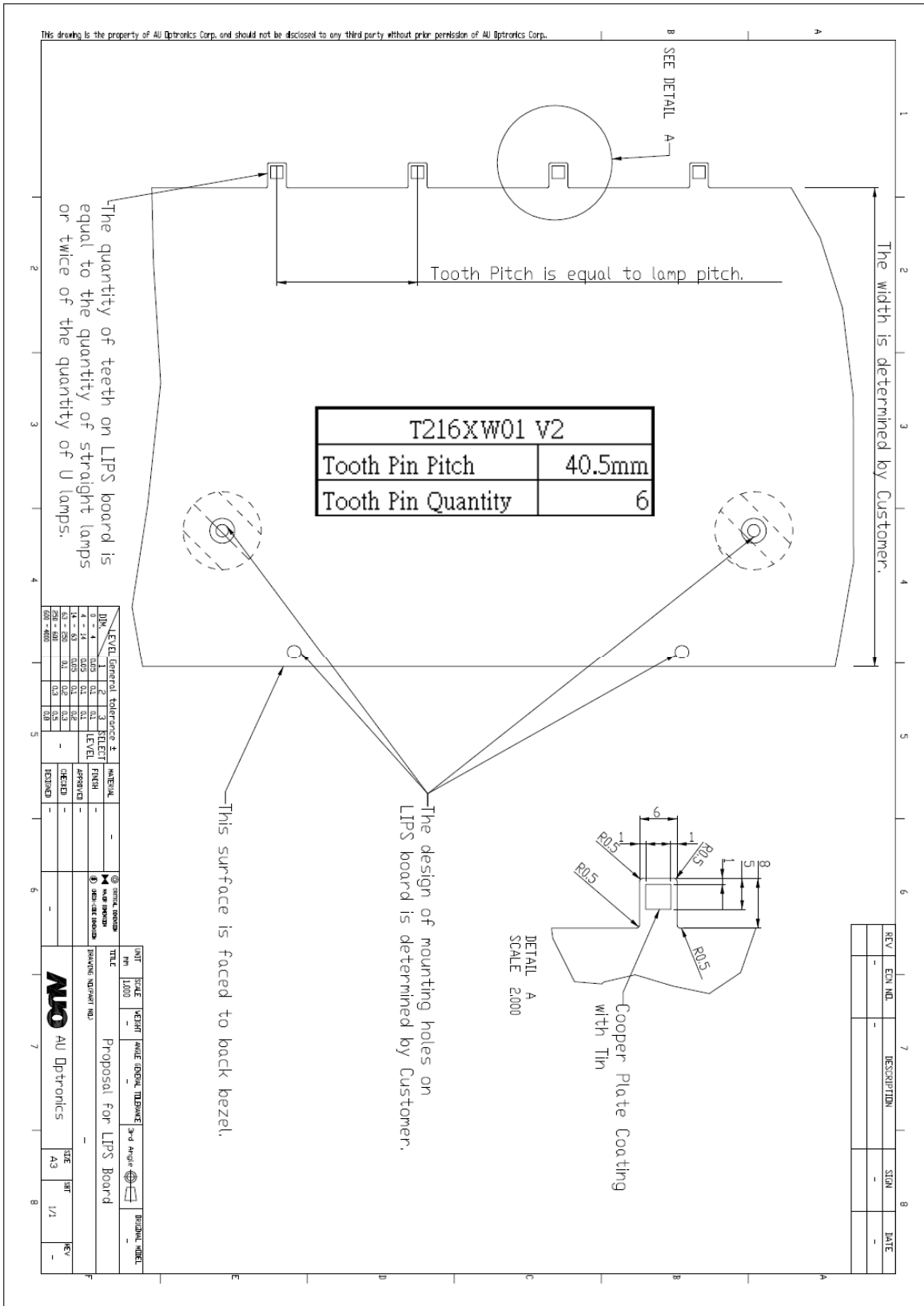

3-3 Signal Timing Specifications

This is the signal timing required at the input of the User connector. All of the interface signal timings should be satisfied with the following specifications for the proper operation.

*** Timing Table**

Signal	Item	Symbol	Min.	Typ.	Max.	Unit
Vertical Section	Period	Tv	776	810	1,015	Th
	Active	Tdisp(v)	768			Th
	Blanking	Tblk (v)	8	42	247	Th
Horizontal Section	Period	Th	1,414	1,648	2,000	Tclk
	Active	Tdisp(h)	1,366			Tclk
	Blanking	Tblk (h)	48	282	634	Tclk
LVDS Clock	Frequency	Fclk (1/Tclk)	50	80	86	MHz
Vertical Frequency	Frequency	Fv	47	60	63	Hz
Horizontal Frequency	Frequency	Fh	43	48	53	kHz

Note :

- 1, CLK signal input must be valid while power supply is applied.
- 2, Display position is specific by the rise of DE signal only. Horizontal display position is specified by the falling edge of 1st CLK right after the rise of DE, is displayed on the left edge of the screen. Vertical display position is specified by the rise of DE after a “Low” level period equivalent to eight times of horizontal period. The 1st data corresponding to one horizontal line after the rise of DE is displayed at the top line of screen.
- 3, If a period of DE “High” is less than 1,366 CLK or less than 768 lines, the rest of the screen displays black.
- 4, The display position does not fit to the screen if a period of DE “High” and the effective data period do not synchronize with each other.

3-4 Signal Timing Waveforms

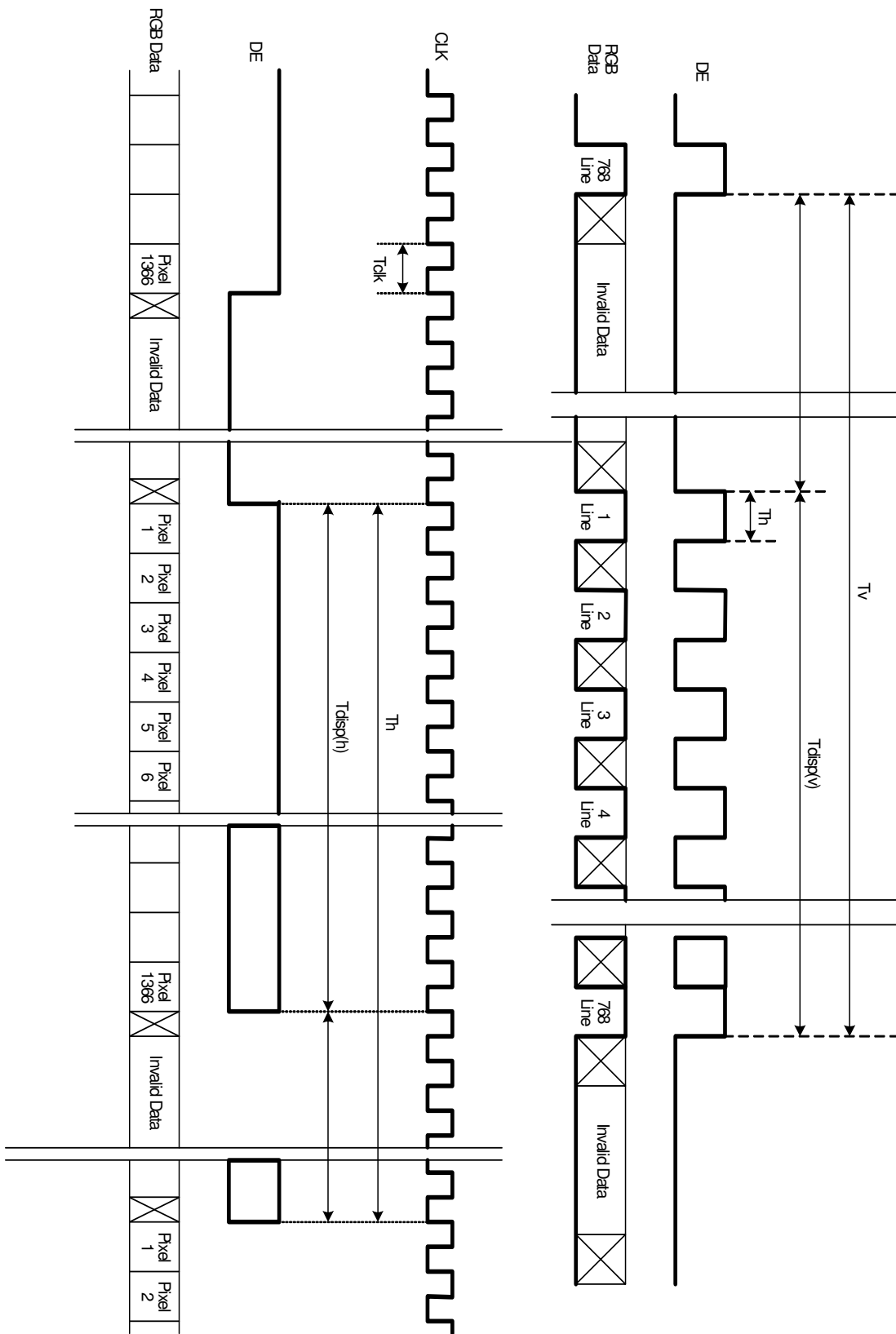



3-5 Color Input Data Reference

The brightness of each primary color (red, green and blue) is based on the 8 bit gray scale data input for the color. The higher the binary input, the brighter the color. The table below provides a reference for color versus data input.

*** COLOR DATA REFERENCE**

Color		Input Color Data																							
		RED								GREEN								BLUE							
		MSB				LSB				MSB				LSB				MSB				LSB			
		R7	R6	R5	R4	R3	R2	R1	R0	G7	G6	G5	G4	G3	G2	G1	G0	B7	B6	B5	B4	B3	B2	B1	B0
Basic Color	Black(L0)	0	0	0	0	0	0	0	0	0	0	0	0	0	0	0	0	0	0	0	0	0	0	0	0
	Red(255)	1	1	1	1	1	1	1	1	0	0	0	0	0	0	0	0	0	0	0	0	0	0	0	0
	Green(255)	0	0	0	0	0	0	0	0	1	1	1	1	1	1	1	1	0	0	0	0	0	0	0	0
	Blue(255)	0	0	0	0	0	0	0	0	0	0	0	0	0	0	0	0	1	1	1	1	1	1	1	1
	Cyan	0	0	0	0	0	0	0	0	1	1	1	1	1	1	1	1	1	1	1	1	1	1	1	1
	Magenta	1	1	1	1	1	1	1	1	0	0	0	0	0	0	0	0	1	1	1	1	1	1	1	1
	Yellow	1	1	1	1	1	1	1	1	1	1	1	1	1	1	1	1	0	0	0	0	0	0	0	0
	White(L255)	1	1	1	1	1	1	1	1	1	1	1	1	1	1	1	1	1	1	1	1	1	1	1	1
RED	RED(000)	0	0	0	0	0	0	0	0	0	0	0	0	0	0	0	0	0	0	0	0	0	0	0	0
	RED(001)	0	0	0	0	0	0	0	1	0	0	0	0	0	0	0	0	0	0	0	0	0	0	0	0

	RED(254)	1	1	1	1	1	1	1	0	0	0	0	0	0	0	0	0	0	0	0	0	0	0	0	0
	RED(255)	1	1	1	1	1	1	1	1	0	0	0	0	0	0	0	0	0	0	0	0	0	0	0	0
GREEN	GREEN(000)	0	0	0	0	0	0	0	0	0	0	0	0	0	0	0	0	0	0	0	0	0	0	0	0
	GREEN(001)	0	0	0	0	0	0	0	0	0	0	0	0	0	0	1	0	0	0	0	0	0	0	0	

	GREEN(254)	0	0	0	0	0	0	0	0	1	1	1	1	1	1	1	0	0	0	0	0	0	0	0	
	GREEN(255)	0	0	0	0	0	0	0	0	1	1	1	1	1	1	1	0	0	0	0	0	0	0	0	
BLUE	BLUE(000)	0	0	0	0	0	0	0	0	0	0	0	0	0	0	0	0	0	0	0	0	0	0	0	0
	BLUE(001)	0	0	0	0	0	0	0	0	0	0	0	0	0	0	0	0	0	0	0	0	0	0	1	

	BLUE(254)	0	0	0	0	0	0	0	0	0	0	0	0	0	0	0	1	1	1	1	1	1	1	0	
	BLUE(255)	0	0	0	0	0	0	0	0	0	0	0	0	0	0	0	1	1	1	1	1	1	1	1	

3-6 Power Sequence

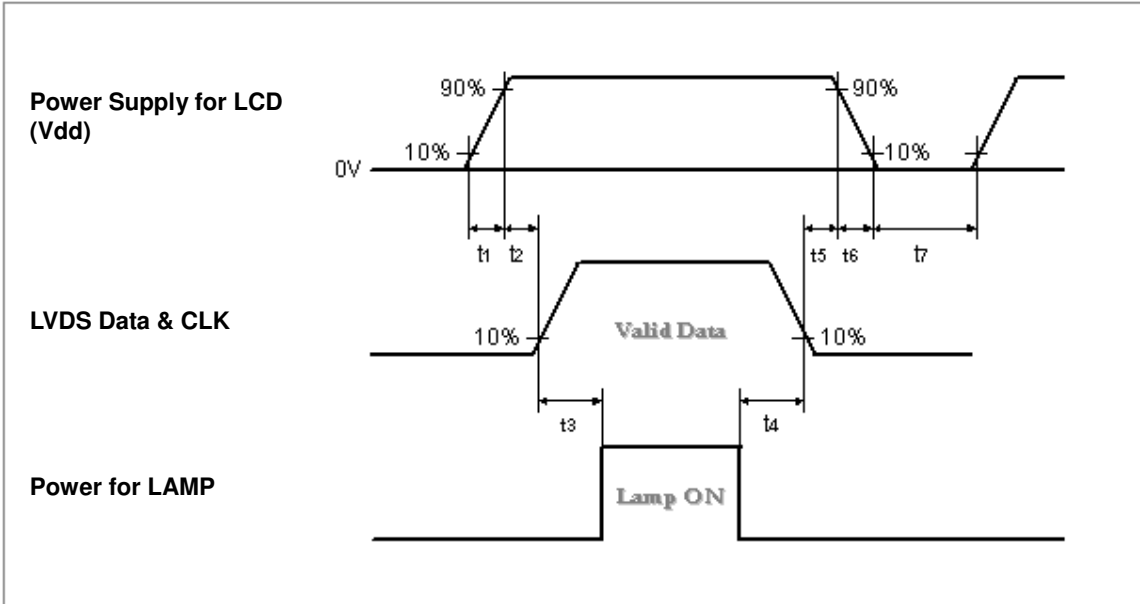

Parameter	Values			Unit
	Min.	Typ.	Max.	
t1	0.4	-	30	ms
t2	0.1	-	50	ms
t3	200	-	-	ms
t4	10	-	-	ms
t5	0.1	-	50	ms
t6	-	-	300	ms
t7	500	-	-	ms

Apply the lamp voltage within the LCD operating range. When the backlight turns on before the LCD operation or the LCD turns off before the backlight turns off, the display may momentarily become abnormal.

Caution :

The above on/off sequence should be applied to avoid abnormal function in the display. In case of handling, make sure to turn off the power when you plug the cable into the input connector or pull the cable out of the connector.

4. Optical Specification

Optical characteristics are determined after the unit has been 'ON' and stable for approximately 30 minutes in a dark environment at 25°C. The values specified are at an approximate distance 50cm from the LCD surface at a viewing angle of Φ and θ equal to 0°.

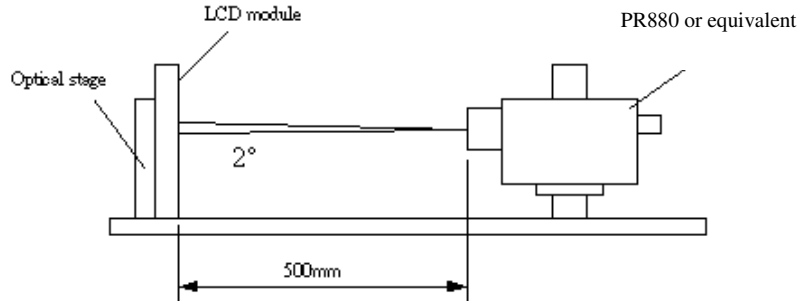

Fig.4-1 Optical measurement equipment and method

Parameter	Symbol	Value			Unit	Note	
		Min.	Typ.	Max.			
Contrast Ratio	CR	2,000	2,500			1	
Surface Luminance, white	LWH	300	350		cd/m ²	2	
Luminance Variation	δ_{WHITE} 9 p			1.3		3	
Response Time	T_{γ}		6.5		ms	4	
Color Gamut			72		%		
Color Coordinates	RED	R_x	Typ.-0.03	0.640	Typ.+0.03		
		R_y		0.330			
	GREEN	G_x		0.290			
		G_y		0.600			
	BLUE	B_x		0.150			
		B_y		0.060			
	WHITE	W_x		0.285			
		W_y		0.293			
Viewing Angle by ELDIM	x axis, right ($\varphi=0^\circ$)	θ_r	65	88		Degree	5
	x axis, left ($\varphi=180^\circ$)	θ_l	65	88		Degree	5
	y axis, up ($\varphi=90^\circ$)	θ_u	55	88		Degree	5
	y axis, down ($\varphi=0^\circ$)	θ_d	55	88		Degree	5

Note :

1, Contrast Ratio (CR) is defined mathematically as:

$$\text{Contrast Ratio} = \frac{\text{Surface Luminance of } L_{on1}}{\text{Surface Luminance of } L_{off1}}$$

2, Surface luminance is luminance value at point 1 across the LCD surface 50cm from the surface with all pixels displaying white. From more information see FIG 4-2. When $I_{BL} = 57\text{mA}$, $L_{WH} = 350\text{cd/m}^2$ (typ.) $L_{WH} = L_{on1}$, Where L_{on1} is the luminance with all pixels displaying white at center 1 location.

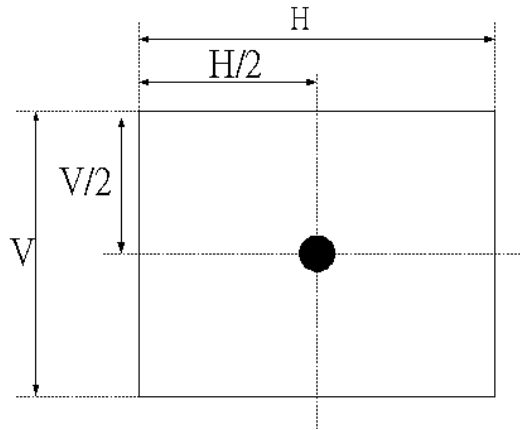

Fig.4-2 Luminance

3, The variation in surface luminance, δ WHITE is defined (center of Screen) as:

$$\delta_{\text{WHITE}(9P)} = \frac{\text{Maximum}(L_{on1}, L_{on2}, \dots, L_{on9})}{\text{Minimum}(L_{on1}, L_{on2}, \dots, L_{on9})}$$

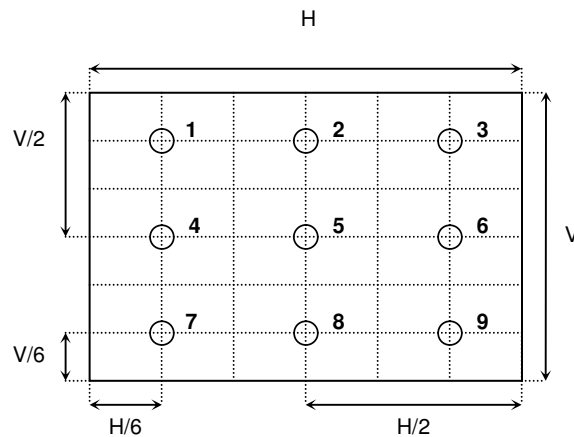

Fig.4-3 Luminance Variation

4, Response time T_{γ} is the average time required for display transition by switching the input signal for five luminance ratio (0%,25%,50%,75%,100% brightness matrix) and is based on $f_v=60\text{Hz}$ to optimize.

	0%	25%	50%	75%	100%
0%		t 0%-25%	t 0%-50%	t 0%-75%	t 0%-100%
25%	t 25%-0%		t 25%-50%	t 25%-75%	t 25%-100%
50%	t 50%-0%	t 50%-25%		t 50%-75%	t 50%-100%
75%	t 75%-0%	t 75%-25%	t 75%-50%		t 75%-100%
100%	t 100%-0%	t 100%-25%	t 100%-50%	t 100%-75%	

5, Viewing angle is the angle at which the contrast ratio is greater than 10. The angles are determined for the horizontal or x axis and the vertical or y axis with respect to the z axis which is normal to the LCD surface. For more information see FIG 4-5.

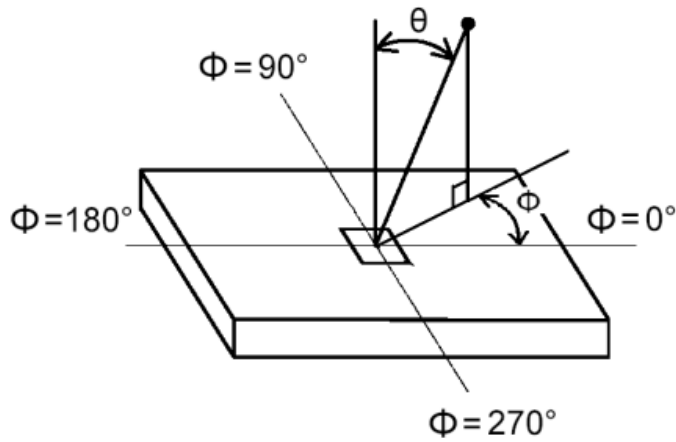

Fig.4-4 Viewing Angle Definition

5. Mechanical Characteristics

The contents provide general mechanical characteristics for the model T216XW01. In addition the figures in the next page are detailed mechanical drawing of the LCD.

Outline Dimension	Horizontal (typ.)	523 mm
	Vertical (typ.)	315 mm
	Depth (typ.)	29 mm (37.5 mm)
Bezel Area	Horizontal (typ.)	481 mm
	Vertical (typ.)	273 mm
Active Display Area	Horizontal	477.417 mm
	Vertical	268.416 mm
Weight	TBD (typ.)	
Surface Treatment	HC, 3H	

5-1 Front View (2D drawing)

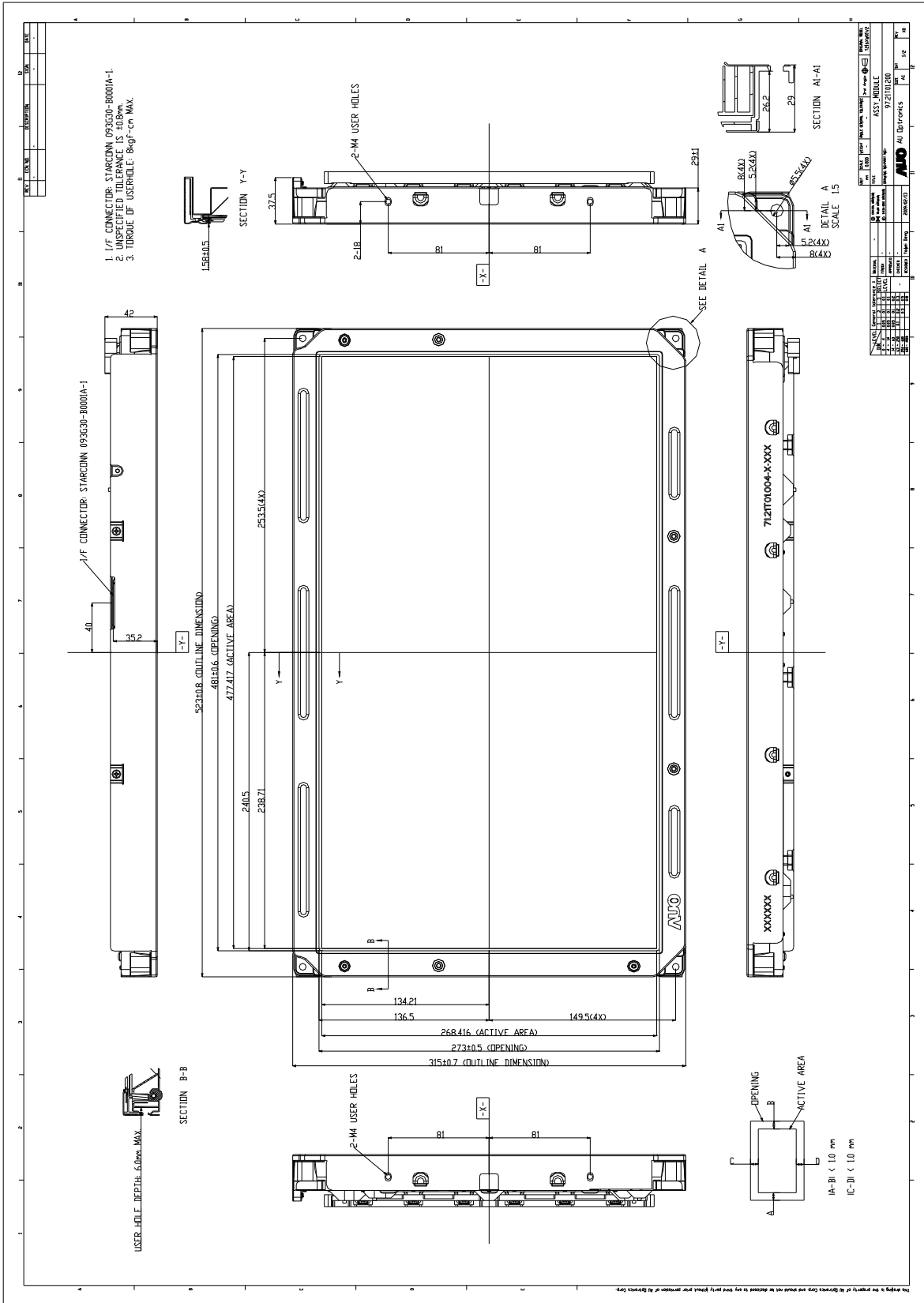

5-2 Rear View (2D drawing)

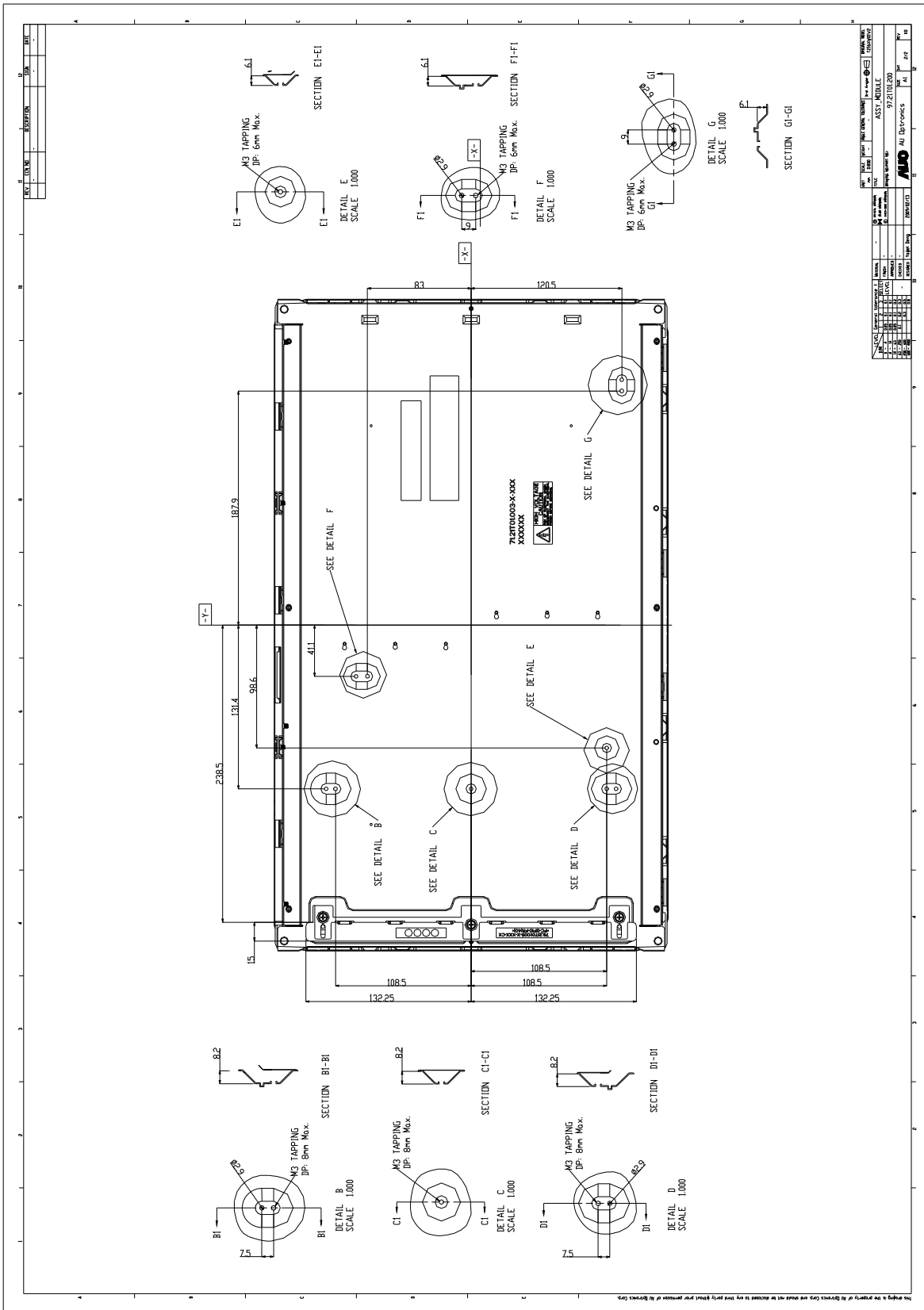

Part Name	ASSY_MOBILE
Part No.	972100300
Rev.	1
DATE	2007/03/23
Drawn By	...
Checked By	...
Approved By	...
Company	AU Optronics

Note :

- 1, Assembly lamp connector type : YEONHO 35001HS-02L

6. Reliability

— Environment test condition

	Test Items	Q'ty	Conditions
1	High Temperature Storage	3	60°C 300 hrs
2	Low Temperature Storage	3	-20°C, 300 hrs
3	High Temperature Operation	3	50°C, 300 hrs
4	Low Temperature Operation	3	-5°C, 300 hrs
5	Vibration (non-operation)	3	(10 ~ 300Hz/1.5G/11min SR, XYZ 30min/axis) Vibration level : 1.5G RMS, Bandwidth : 10-300Hz Duration: X, Y, Z 30min,
6	Shock (non-operation)	3	Shock level: 50G Waveform: have sine wave, 11ms Direction: ±X,±Y, ±Z One time each direction
7	Vibration (With carton)	3	Random wave (1.5 Grms 10~200Hz) 30mins / Per each X.Y.Z axes
8	Drop (With carton)	3	Height: 45.7cm 1 corner, 3 edges, 6 surfaces (ASTMD4169-I)

7. International Standard

7-1 Safety

1, UL6500, Underwriters Laboratories, Inc. (AUO file number : E204356)

Standard for Safety of Information Technology Equipment Including electrical Business Equipment.

2, CAN/CSA C22.2 No. 950-95 Third Edition, Canadian Standards Association, Jan. 28, 1995

Standard for Safety of Information Technology Equipment Including Electrical Business Equipment.

3, EN60950 : 1992+A2: 1993+A2: 1993+C3: 1995+A4: 1997+A11: 1997

IEC 950: 1991+A1: 1992+A2: 1993+C3: 1995+A4:1996

IEC 60065

European Committee for Electro technical Standardization (CENELEC)

EUROPEAN STANDARD for Safety of Information Technology Equipment Including Electrical Business Equipment.

7-2. EMC

1, ANSI C63.4 “Methods of Measurement of Radio-Noise Emissions from Low-Voltage Electrical and Electrical Equipment in the Range of 9kHz to 40GHz. “American National standards Institute(ANSI), 1992

2, C.I.S.P.R “Limits and Methods of Measurement of Radio Interface Characteristics of Information Technology Equipment.” International Special committee on Radio Interference.

3, EN 55022 “Limits and Methods of Measurement of Radio Interface Characteristics of Information Technology Equipment.” European Committee for Electrotechnical Standardization. (CENELEC), 1998

7-3 Green

Green Mark Description:

1, For Pb Free products, AUO will add  for identification.

2, For RoHS compatible products, AUO will add  for identification.

Note :

The Green Mark will be present only when the green documents have been ready by AUO Internal Green Team. (The definition of green design follows the AUO green design checklist.)

8. Packing

8-1 Packing Instruction

By air & by sea : 4pcs/carton, (4*2)*2 layers, 16 boxes in a pallet, total 64 pcs of module in a pallet, 20 pallets/40"DC

Pallet Dimension : 1,150 * 1180 * 132 mm

Dimension : 1,150 * 1180 * 1,944 mm

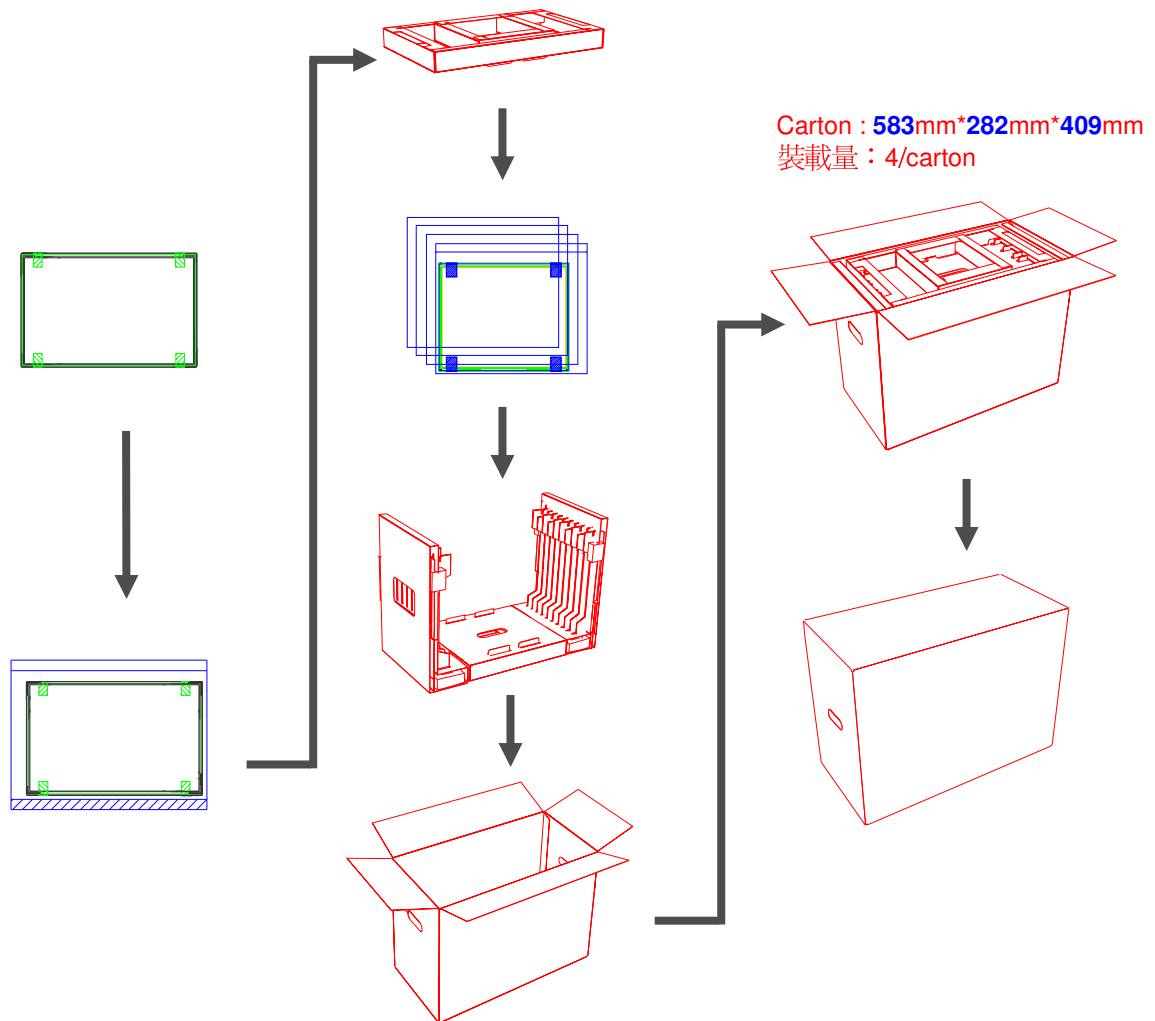

8-2 Shipping Label

Shipping Label : 100 mm * 23 mm

	Manufactured: XX/XX Model No : T216XW01 V2 AU Optronics XXXXG Made in XXX			
XXXXXXXXXXXX-XXXX				
XXXXXXXXXXXXXXXXXXXXXXXX				

8-3 Carton Label

Carton Label : 80 mm * 40 mm

QTY:6		
MODEL NO: T216XW01 V2 PART NO: 97.21T01.200 CUSTOMER NO:		
CARTON NO:		
Made in XXXXXX	*XXXXX-XXXXXXXXXX*	

9. PRECAUTIONS

Please pay attention to the followings when you use this TFT LCD module.

9-1 MOUNTING PRECAUTIONS

- 1, You must mount a module using holes arranged in four corners or four sides.
- 2, You should consider the mounting structure so that uneven force (ex. Twisted stress) is not applied to module. And the case on which a module is mounted should have sufficient strength so that external force is not transmitted directly to the module.
- 3, Please attach the surface transparent protective plate to the surface in order to protect the polarizer. Transparent protective plate should have sufficient strength in order to resist external force.
- 4, You should adopt radiation structure to satisfy the temperature specification.
- 5, Acetic acid type and chlorine type materials for the cover case are not desirable because the former generates corrosive gas of attacking the polarizer at high temperature and the latter causes circuit break by electro-chemical reaction.
- 6, Do not touch, push or rub the exposed polarizers with glass, tweezers or anything harder than HB pencil lead. And please do not rub with dust clothes with chemical treatment. Do not touch the surface of polarizer for bare hand or greasy cloth. (Some cosmetics are detrimental to the polarizer.)
- 7, When the surface becomes dusty, please wipe gently with absorbent cotton or other soft materials like chamois soaks with petroleum benzene. Normal-hexane is recommended for cleaning the adhesives used to attach front/ rear polarizers. Do not use acetone, toluene and alcohol because they cause chemical damage to the polarizer.
- 8, Wipe off saliva or water drops as soon as possible. Their long time contact with polarizer causes deformations and color fading.
- 9, Do not open the case because inside circuits do not have sufficient strength.

9-2 OPERATING PRECAUTIONS

- 1, The device listed in the product specification sheets was designed and manufactured for TV application
- 2, The spike noise causes the mis-operation of circuits. It should be lower than following voltage:
 $V = \pm 200\text{mV}$ (Over and under shoot voltage)
- 3, Response time depends on the temperature. (In lower temperature, it becomes longer..)
- 4, Brightness depends on the temperature. (In lower temperature, it becomes lower.) And in lower temperature, response time (required time that brightness is stable after turned on) becomes longer.
- 5, Be careful for condensation at sudden temperature change. Condensation makes damage to polarizer or electrical contacted parts. And after fading condensation, smear or spot will occur.
- 6, When fixed patterns are displayed for a long time, remnant image is likely to occur.

7, Module has high frequency circuits. Sufficient suppression to the electromagnetic interference shall be done by system manufacturers. Grounding and shielding methods may be important to minimize the interface.

9-3 ELECTROSTATIC DISCHARGE CONTROL

Since a module is composed of electronic circuits, it is not strong to electrostatic discharge. Make certain that treatment persons are connected to ground through wrist band etc. And don't touch interface pin directly.

9-4 PRECAUTIONS FOR STRONG LIGHT EXPOSURE

Strong light exposure causes degradation of polarizer and color filter.

9-5 STORAGE

When storing modules as spares for a long time, the following precautions are necessary.

- 1, Store them in a dark place. Do not expose the module to sunlight or fluorescent light. Keep the temperature between 5°C and 35°C at normal humidity.
- 2, The polarizer surface should not come in contact with any other object. It is recommended that they be stored in the container in which they were shipped.

9-6 HANDLING PRECAUTIONS FOR PROTECTION FILM

- 1, The protection film is attached to the bezel with a small masking tape. When the protection film is peeled off, static electricity is generated between the film and polarizer. This should be peeled off slowly and carefully by people who are electrically grounded and with well ion-blown equipment or in such a condition, etc.
- 2, When the module with protection film attached is stored for a long time, sometimes there remains a very small amount of glue still on the Bezel after the protection film is peeled off.
- 3, You can remove the glue easily. When the glue remains on the Bezel or its vestige is recognized, please wipe them off with absorbent cotton waste or other soft material like chamois soaked with normal-hexane.