



Product Description: 23" WXGA Color TFT-LCD Module	
.....	
AUO Model Name: T230XW01 V1	
Customer Part No/Project Name:	
Customer Signature	AUO 2007/01/02
	Approved By: <b>Hong Jye Hong</b>
	Reviewed By: <b>Ming Ku</b>
	Prepared By: <b>Jerry Lee</b>

Please return one copy with your signature and comments for our confirmation.

\* No Reproduction and Redistribution Allowed



## **Product Specifications**

**23" WXGA Color TFT-LCD Module  
Model Name: T230XW01**

**( ) Preliminary Specifications  
(\* ) Final Specifications**



## Contents

No	ITEM
	COVER
	CONTENTS
	RECORD OF REVISIONS
1	GENERAL DESCRIPTION
2	ABSOLUTE MAXIMUM RATINGS
3	ELECTRICAL SPECIFICATIONS
3-1	ELECTRICAL CHARACTERISTICS
3-2	INTERFACE CONNECTIONS
3-3	SIGNAL TIMING SPECIFICATIONS
3-4	SIGNAL TIMING WAVEFORMS
3-5	COLOR INPUT DATA REFERENCE
3-6	POWER SEQUENCE
4	OPTICAL SPECIFICATIONS
5	MECHANICAL CHARACTERISTICS
6	INTERNATIONAL STANDARDS
6-1	SAFETY
6-2	EMC
7	PACKING (Green Mark Description)
8	PRECAUTIONS



## Record of Revision

Version	Date	Page	Old Description	New Description	Remark
1.1	06/08/22	-	-	First Draft	
1.2	06/10/30	8	Inrush current	Update from 1.2mA to 3mA	
1.3	07/01/02	8	Power supply input voltage	Update TBD data	
			Power supply input current	Update TBD data	
			Power consumption	Update TBD data	



## 1. General Description

This specification applies to the 23.0 inch Color TFT-LCD Module T230XW01.

This module supports the WXGA (1366(H) x 768(V)) screen format and 16.7M colors (6-bits + FRC).

All input signals are 1 channel LVDS interface compatible.

This module includes inverter card for backlight.

## Features

- WXGA 1366(H) x 768(V) resolution
- Fast response Time (8ms)
- 50,000 hours lamp life
- 8 CCFL Direct Type Backlight Design (Cold Cathode Fluorescent Lamp)
- High brightness, High contrast ratio
- Wide viewing angle
- Low power consumption
- Green Design (ROHS Compliance)
- HDTV Ready Module

## Application

Personal TV

Bedroom TV or 2<sup>nd</sup> TV Application

Multi-function media



## \* General Information

The following items are characteristics summary on the table 25 °C condition:

Items	Specification	Unit	Note
Active Screen Size	22.95 inches		58.296cm diagonal
Display Area	508.152(H) x 285.696(V)	mm	
Outline Dimension	546.0(H) x 318.3(V) x 46.0(D) (Max.)	mm	
Resolution	1366(R,G,Bx3) x 768	Pixels	
Pixel Pitch	0.372 x 0.372	mm	
Pixel Arrangement	RGB vertical stripe		
Display mode	TN mode, Normally White		
Display Colors	16.7M (6-bit + FRC for R,G,B)	Colors	
Typical White Luminance	450 nit (typ.)	[cd/m <sup>2</sup> ]	
Contrast Ratio	700:1 (typ.)		
Color Gamut	72% (typ.) of NTSC		
Response Time	8ms(typ.) (Tr+Tf)	ms	
Viewing Angle (H/V)	160/160		CR>10
Power Consumption	54.03 (typ.)	W	
Electronic Interface	1ch LVDS		
Frame rate	60Hz (typ.), 75Hz (max.)	Hz	
Weight(g)	3300(typ.)	g	
Surface Treatment	Hard-Coating 3H, AG		
ROHS	ROHS compliance		



## 2. Absolute Maximum Ratings

The following are maximum values which, if exceeded, may cause faulty operation or damage to the unit.

Item	Symbol	Min	Max	Unit	Note
Logic/LCD Drive Voltage	V <sub>dd</sub>	-0.3	14.0	[Volt]	1
Input Voltage of Signal	V <sub>in</sub>	-0.3	3.6	[Volt]	1
Operating Temperature	T <sub>OP</sub>	0	+50	[°C]	2
Operating Humidity	H <sub>OP</sub>	10	90	[%RH]	2
Storage Temperature	T <sub>ST</sub>	-20	+60	[°C]	2
Storage Humidity	H <sub>ST</sub>	10	90	[%RH]	2

Note 1 : Duration = 50msec

Note 2 : Maximum Wet-Bulb should be 39°C and No condensation.

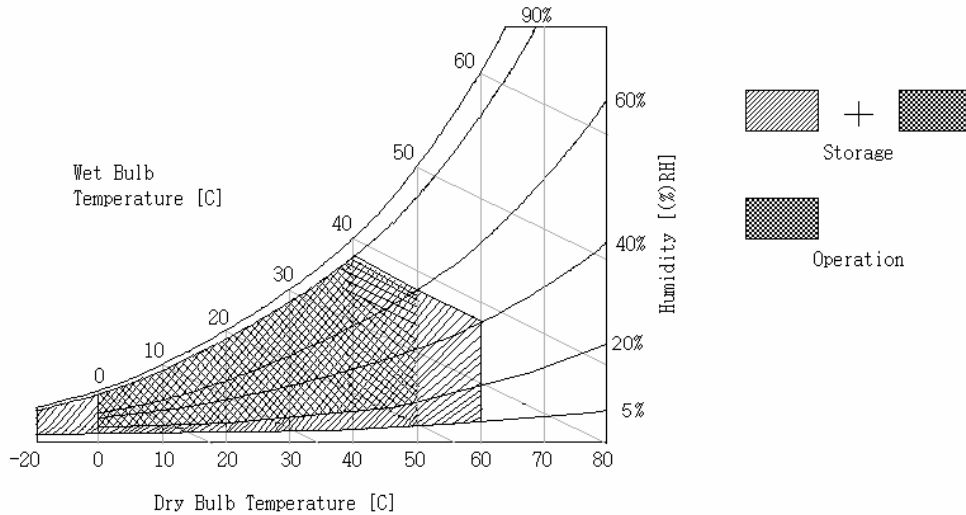



### 3. Electrical Specification

The T230XW01 requires two power inputs. One is employed to power the LCD electronics and to drive the TFT array and liquid crystal. An inverter typically generates the second input, which powers the CCFL.

#### 3-1 Electrical Characteristics

Parameter	Symbol	Values			Unit	Notes
		Min	Typ	Max		
LCD:						
Power Supply Input Voltage	Vdd	4.1	5.0	5.9	Vdc	
Power Supply Input Current	I <sub>dd</sub>	-	590	840	A	1
Power Consumption	P <sub>c</sub>	-	2.95	4.7	Watt	1
Inrush Current	I <sub>RUSH</sub>			3	A	1
Backlight Power Consumption		45.6	50.4	55.2	Watt	2
Total Power Consumption		-	54.03	59.52	Watt	2
Life Time		50,000		-	Hours	3

The performance of the Lamp in LCM, for example lifetime or brightness, is extremely influenced by the characteristics of the DC-AC Inverter. So all the parameters of an inverter should be carefully designed so as not to produce too much leakage current from high-voltage output of the inverter. When you design or order the inverter, please make sure unwanted lighting caused by the mismatch of the lamp and the inverter (no lighting, flicker, etc) never occurs. When you confirm it, the LCD Assembly should be operated in the same condition as installed in your instrument.

Do not attach a conducting tape to lamp connecting wire. If the lamp wire attach to conducting tape, TFT-LCD Module have a low luminance and the inverter has abnormal action because leakage current occurs between lamp wire and conducting tape.

The relative humidity must not exceed 80% non-condensing at temperatures of 40 °C or less. At temperatures greater than 40 °C, the wet bulb temperature must not exceed 39 °C. When operate at low temperatures, the brightness of CCFL will drop and the lifetime of CCFL will be reduced.

**Note :**

1. V<sub>dd</sub>=12.0V, F<sub>v</sub>=62Hz, f<sub>CLK</sub>= 88MHz , 25 °C, V<sub>dd</sub> Duration time= 470 μs

The Power supply input check pattern definition and dissipation reference as below :

Dot pattern : 373mA (Max.)



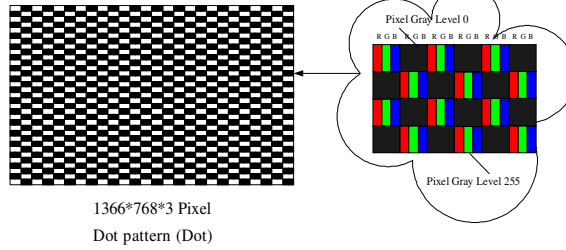

White pattern : 290m A

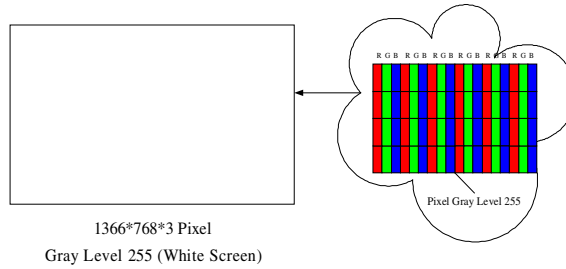

Black pattern : 345m A

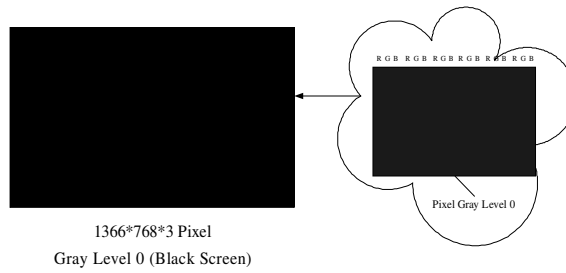

Vertical gray scale pattern : 311m A(Typ.)

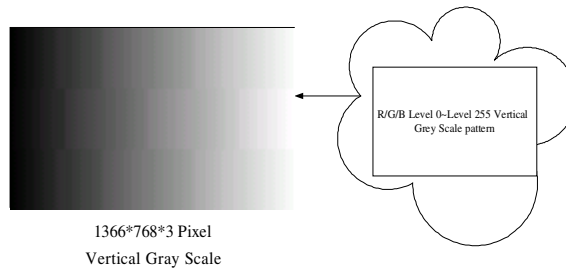

2. The lamp power consumption shown above does include loss of external inverter at 25 °C..
3. The life is determined as the time at which luminance of the lamp is 50% compared to that of initial value at the typical lamp current on condition of continuous operating at 25 ±2°C.



### 3-2 Interface Connections

- LCD connector (CN1): JAE FI-E30S or equivalent
- LVDS Transmitter: DS90C385 (NS) or equivalent

**Note:**

1. All GND (ground) pins should be connected together and should also be connected to the LCD's metal frame. All Vdd (power input) pins should be connected together.

Pin No	Symbol	Description	Note
1	N.C.	No Connection ( Auo internal Test Pin)	
2	N.C.	No Connection ( Auo internal Test Pin)	
3	N.C.	No Connection ( Auo internal Test Pin)	
4	GND	Ground	
5	Rx0-	LVDS Channel 0 [Polarity: Negative]	
6	Rx0+	LVDS Channel 0 [Polarity: Positive]	
7	GND	Ground	
8	Rx1-	LVDS Channel 1 [Polarity: Negative]	
9	Rx1+	LVDS Channel 1 [Polarity: Positive]	
10	GND	Ground	
11	Rx2-	LVDS Channel 2 [Polarity: Negative]	
12	Rx2+	LVDS Channel 2 [Polarity: Positive]	
13	GND	Ground	
14	RXCLK-	LVDS Clock [Polarity: Negative]	
15	RXCLK+	LVDS Clock [Polarity: Positive]	
16	GND	Ground	
17	Rx3-	LVDS Channel 3 [Polarity: Negative]	
18	Rx3+	LVDS Channel 3 [Polarity: Positive]	
19	GND	Ground	
20	N.C.	No Connection ( Auo internal Test Pin)	
21	LVDS Option*	Low for JEIDA, High/Open for NS	
22	N.C.	No Connection ( Auo internal Test Pin)	
23	GND	Ground	
24	GND	Ground	
25	GND	Ground	
26	Vdd (+5V)	5V, DC, Regulated	
27	Vdd (+5V)	5V, DC, Regulated	
28	Vdd (+5V)	5V, DC, Regulated	
29	Vdd (+5V)	5V, DC, Regulated	
30	Vdd (+5V)	5V, DC, Regulated	



**LVDS Option = L (GND)**

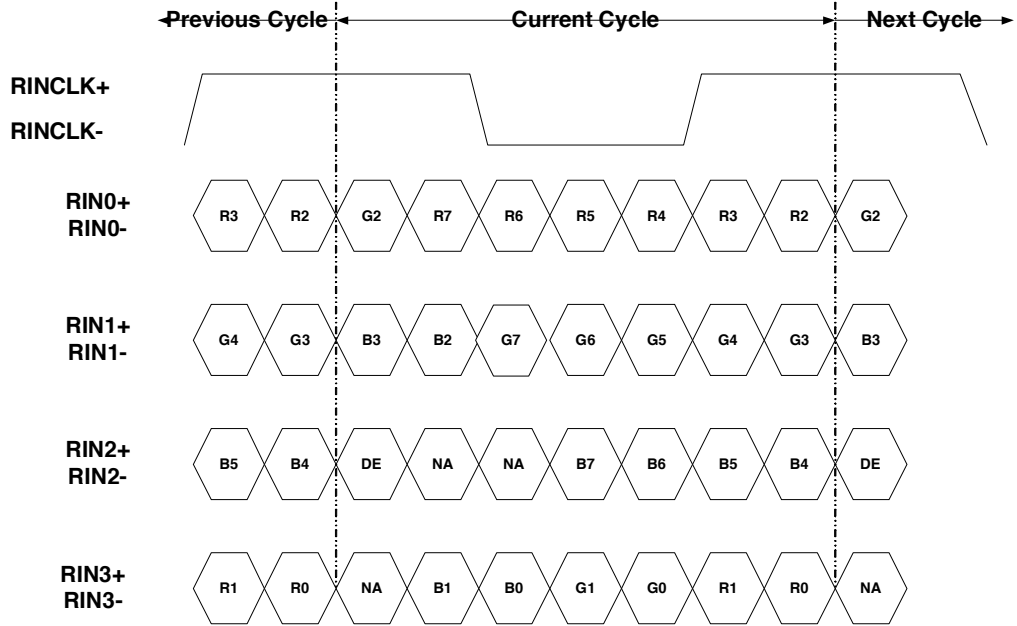

**LVDS Option = H (3.3V) / Open**

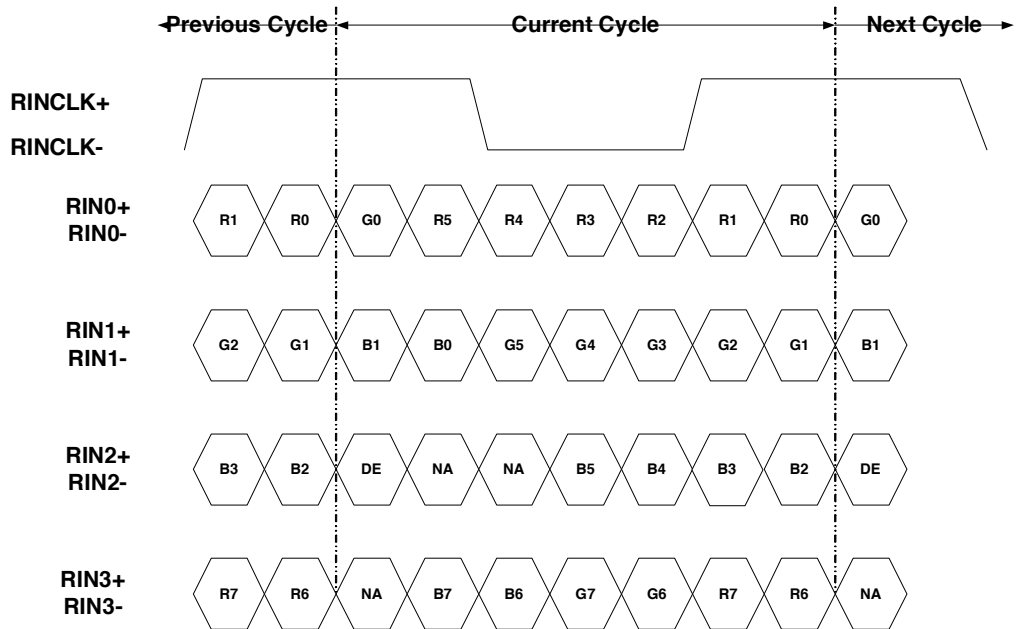



## Backlight Connector Pin Configuration

### 1. Electrical specification

Item	Symb.	Condition	Spec			Units	Note.	
			Min	Typ	Max			
Input Voltage	VDDB	-	21.6	24	26.4	VDC		
Input Current	IDDB	VDDB=24V	1.9	2.1	2.3	ADC	1	
Input Power	PDDB	VDDB=24V	45.6	50.4	55.2	W	1	
Inrush Current	IRUSH	VDDB=24V	-	-	3.15	ADC	1,2	
On/Off Control Voltage	VBLON	ON	VDDB=24V	2	-	5.25	VDC	
		OFF	VDDB=24V	0	-	0.8		
On/Off Control Current	IBLON	VDDB=24V	0	-	1.5	mADC		
Dimming Control Voltage	VDIM	MAX	VDDB=24V	-	3.3	-	VDC	1
		MIN	VDDB=24V	-	0	-		

Note1. VDIM = 3.3V (Ta = 25+-5°C, Turn on for 45 minutes)

Note2. Measurement condition rising time = 20ms (VDD: 10%~90%)

### 2. Inverter Pin Assignment

Connector (CN1) : JST\_S14B-PH-SM3-TB or equivalent

Pin No.	Symbol	Description	Default
1	VDDB	Operation Voltage Supply, +24V DC regulated	24V
2	VDDB	Operation Voltage Supply, +24V DC regulated	24V
3	VDDB	Operation Voltage Supply, +24V DC regulated	24V
4	VDDB	Operation Voltage Supply, +24V DC regulated	24V
5	VDDB	Operation Voltage Supply, +24V DC regulated	24V
6	GND	Ground and Current Return	GND
7	GND	Ground and Current Return	GND
8	GND	Ground and Current Return	GND
9	GND	Ground and Current Return	GND
10	GND	Ground and Current Return	GND
11	N.C	This pin is floating inside ;	N.C
12	VBLON	BL On-Off: Open/High (3.3V) for BL On as default	On
13	PDIM	Internal PWM ; 0V (GND) min Lum / 3.3V (open)Max Lum	100%
14	N.C	This pin is floating inside ;	N.C



### 3-3 Signal Timing Specifications

This is the signal timing required at the input of the User connector. All of the interface signal timing should be satisfied with the following specifications for it's proper operation.

**\* Timing Table**

Signal	Item	Symbol	Min	Type	Max	Unit
Vertical Section	Period	Tv	784	806	1063	Th
	Active	Tdisp (v)	—	768	—	Th
	Blanking	Tblk (v)	16	38	295	Th
Horizontal Section	Period	Th	1434	1560	2000	Tclk
	Active	Tdisp (h)	—	1366	—	Tclk
	Blanking	Tblk (h)	68	194	634	Tclk
Clock	Period	Tclk	11.36	13.16	18.19	ns
	Frequency	Freq	55	76	85	MHz
Vertical Frequency	Frequency	Vs	48	60	75	Hz
Horizontal Frequency	Frequency	Hs	39.45		61.65	KHz

- 1.) Display position is specific by the rise of DE signal only.  
Horizontal display position is specified by the rising edge of 1<sup>st</sup> DCLK after the rise of 1<sup>st</sup> DE, is displayed on the left edge of the screen.  
Vertical display position is specified by the rise of DE after a “Low” level period equivalent to eight times of horizontal period. The 1<sup>st</sup> data corresponding to one horizontal line after the rise the of 1<sup>st</sup> DE is displayed at the top line of screen.
- 3.) If a period of DE “High” is less than 1366 DCLK or less than 768 lines, the rest of the screen displays black.
- 4.) The display position does not fit to the screen if a period of DE “High” and the effective data period do not synchronize with each other.

### 3-4 Signal Timing Waveforms

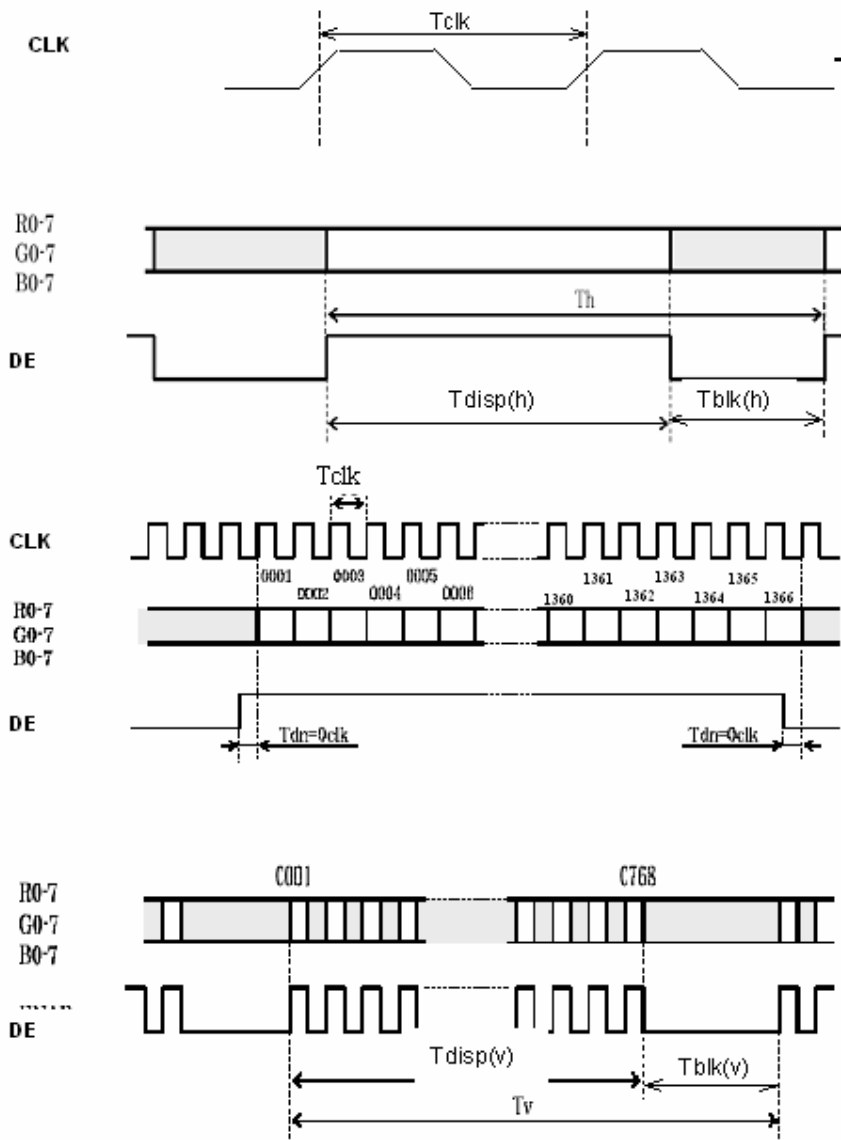



### 3-5 Color Input Data Reference

The brightness of each primary color (red, green and blue) is based on the 8 bit gray scale data input for the color; the higher the binary input, the brighter the color. The table below provides a reference for color versus data input.

#### COLOR DATA REFERENCE

Color		Input Color Data																						
		RED								GREEN								BLUE						
		MSB				LSB				MSB				LSB				MSB		LSB				
		R7	R6	R5	R4	R3	R2	R1	R0	G7	G6	G5	G4	G3	G2	G1	G0	B7	B6	B5	B4	B3	B2	B1
Basic Color	Black(L0)	0	0	0	0	0	0	0	0	0	0	0	0	0	0	0	0	0	0	0	0	0	0	0
	Red	1	1	1	1	1	1	1	1	0	0	0	0	0	0	0	0	0	0	0	0	0	0	0
	Green	0	0	0	0	0	0	0	0	1	1	1	1	1	1	1	0	0	0	0	0	0	0	0
	Blue	0	0	0	0	0	0	0	0	0	0	0	0	0	0	0	1	1	1	1	1	1	1	1
	Cyan	0	0	0	0	0	0	0	0	1	1	1	1	1	1	1	1	1	1	1	1	1	1	1
	Magenta	1	1	1	1	1	1	1	1	0	0	0	0	0	0	0	1	1	1	1	1	1	1	1
	Yellow	1	1	1	1	1	1	1	1	1	1	1	1	1	1	1	0	0	0	0	0	0	0	0
	White(L255)	1	1	1	1	1	1	1	1	1	1	1	1	1	1	1	1	1	1	1	1	1	1	
RED	RED	0	0	0	0	0	0	0	0	0	0	0	0	0	0	0	0	0	0	0	0	0	0	
	RED	0	0	0	0	0	0	0	1	0	0	0	0	0	0	0	0	0	0	0	0	0	0	
	----																							
	RED	1	1	1	1	1	1	1	0	0	0	0	0	0	0	0	0	0	0	0	0	0	0	
	RED	1	1	1	1	1	1	1	1	0	0	0	0	0	0	0	0	0	0	0	0	0	0	
GREEN	GREEN	0	0	0	0	0	0	0	0	0	0	0	0	0	0	0	0	0	0	0	0	0	0	
	GREEN	0	0	0	0	0	0	0	0	0	0	0	0	0	0	1	0	0	0	0	0	0	0	
	----																							
	GREEN	0	0	0	0	0	0	0	0	1	1	1	1	1	1	0	0	0	0	0	0	0	0	
	GREEN)	0	0	0	0	0	0	0	0	1	1	1	1	1	1	0	0	0	0	0	0	0	0	
BLUE	BLUE	0	0	0	0	0	0	0	0	0	0	0	0	0	0	0	0	0	0	0	0	0	0	
	BLUE	0	0	0	0	0	0	0	0	0	0	0	0	0	0	0	0	0	0	0	0	0	1	
	-----																							
	BLUE	0	0	0	0	0	0	0	0	0	0	0	0	0	0	0	1	1	1	1	1	1	1	0
	BLUE	0	0	0	0	0	0	0	0	0	0	0	0	0	0	0	1	1	1	1	1	1	1	1

### 3-6 Power Sequence

#### 3.6.1 Power Sequence for LCD

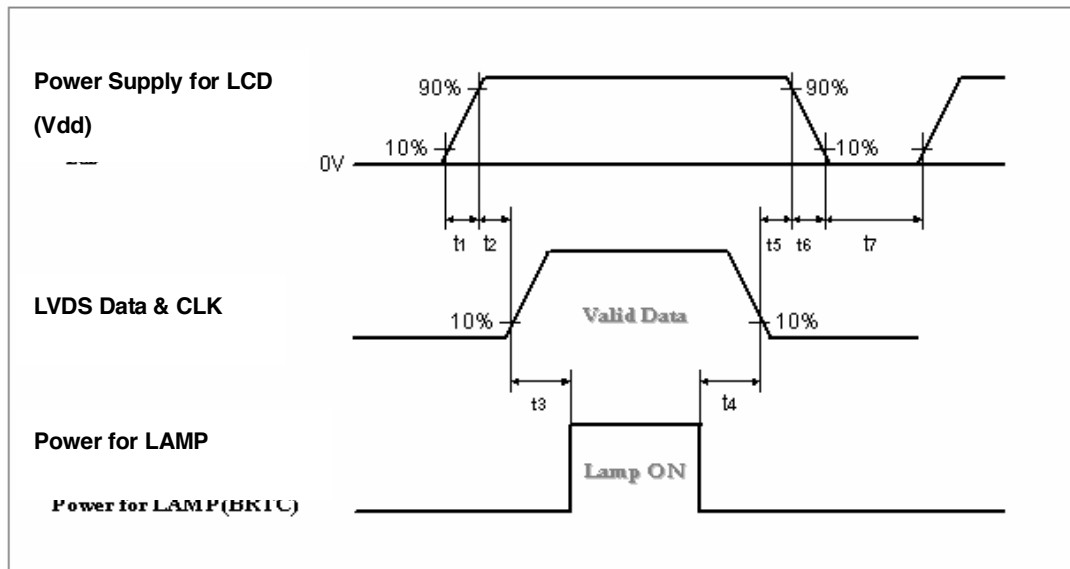

Parameter	Values			Units
	Min.	Typ.	Max.	
t1	0.47	-	20	ms
t2	20	-	50	ms
t3	200	-	-	ms
t4	10	-	-	ms
t5	1	-	50	ms
t6	-	-	300	ms
t7	1000	-	-	ms

Apply the lamp voltage within the LCD operating range. When the backlight turns on before the LCD operation or the LCD turns off before the backlight turns off, the display may momentarily become abnormal.

**Caution :** The above on/off sequence should be applied to avoid abnormal function in the display. In case of handling, make sure to turn off the power when you plug the cable into the input connector or pull the cable out of the connector.



### 3.6.2 Power Sequence for Inverter

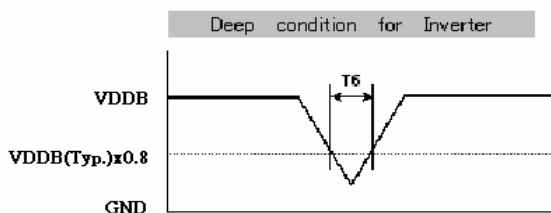
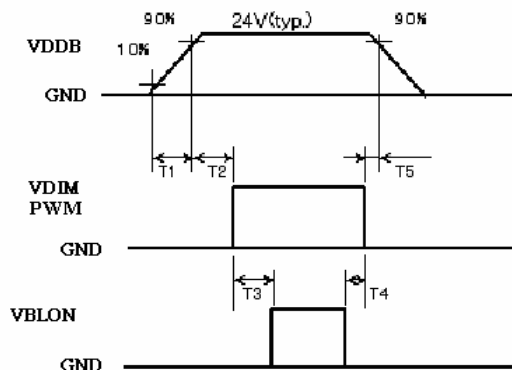

Parameter	Values			Units
	Min.	Typ.	Max.	
T1	20	-	-	ms
T2	50	-	-	ms
T3	50	-	-	ms
T4	50	-	-	ms
T5	0	-	-	ms
T6	-	-	10	ms

## 4. Optical Specification

Optical characteristics are determined after the unit has been 'ON' and stable for approximately 30 minutes in a dark environment at 25°C. The values specified are at an approximate distance 50cm from the LCD surface at a viewing angle of  $\Phi$  and  $\theta$  equal to 0°.

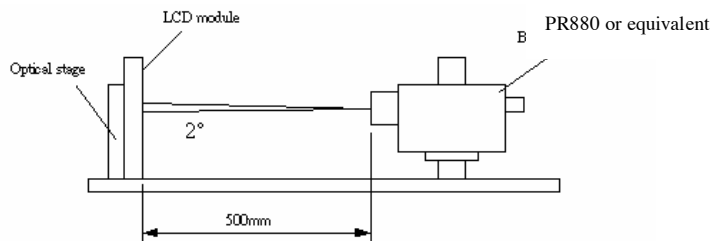

Fig.4-1 Optical measurement equipment and method

Parameter	Symbol	Values			Units	Notes	
		Min.	Typ.	Max.			
Contrast Ratio	CR	550	700			1	
Surface Luminance, white	LWH	360	450		cd/m <sup>2</sup>	2	
Luminance Variation	$\delta_{\text{WHITE}}$ } 9 p			1.25		3	
Response Time	$T_{\gamma}$		8	16	ms	4,5 (Tr+Tf)	
	Rise Time		Tr	7	13	ms	
	Decay Time		Tf	1	3	ms	
<b>Color Coordinates</b>							
	RED	R <sub>X</sub>		0.638			
		R <sub>Y</sub>		0.337			
	GREEN	G <sub>X</sub>		0.299			
		G <sub>Y</sub>	Typ.-0.03	0.604	Typ.+0.03		
	BLUE	B <sub>X</sub>		0.145			
		B <sub>Y</sub>		0.059			
	WHITE	W <sub>X</sub>		0.280			
		W <sub>Y</sub>		0.292			
<b>Viewing Angle by ELDIM</b>							
<b>Contrast Ratio &gt;10</b>							
x axis, right( $\varphi = 0^\circ$ )		$\theta_r$	65	80	Degree	6	
x axis, left( $\varphi = 180^\circ$ )		$\theta_l$	65	80			
y axis, up( $\varphi = 90^\circ$ )		$\theta_u$	65	80			
y axis, down ( $\varphi = 0^\circ$ )		$\theta_d$	65	80			

Note:

1. Contrast Ratio (CR) is defined mathematically as:

$$\text{Contrast ratio (CR)} = \frac{\text{Brightness on the white (L255) state}}{\text{Brightness on the black (L0) state}}$$

2. Surface luminance is luminance value at point 1 across the LCD surface 50cm from the surface with all pixels displaying white. From more information see FIG 4-2. When  $I_{BL} = 6.5\text{mA}$ ,  $L_{WH} = 450\text{cd/m}^2$  (typ.)  $L_{WH} = L_{on1}$ , Where  $L_{on1}$  is the luminance with all pixels displaying white at center 1 location.

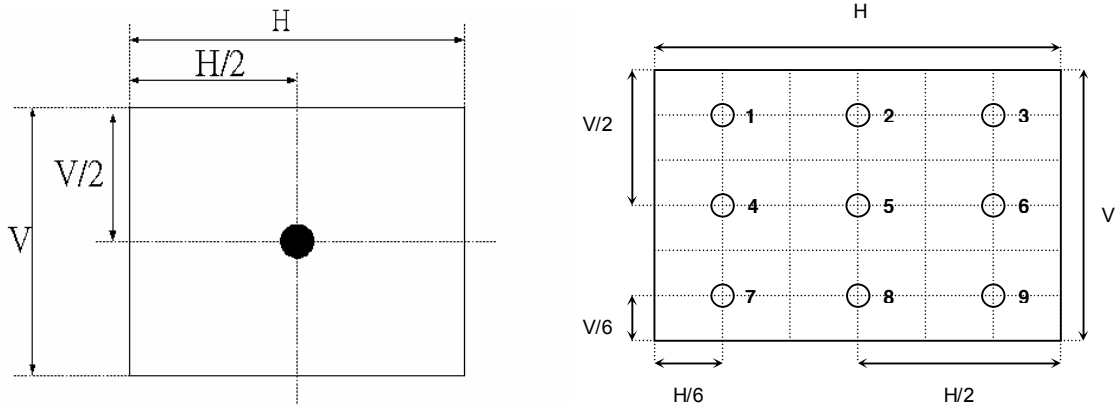
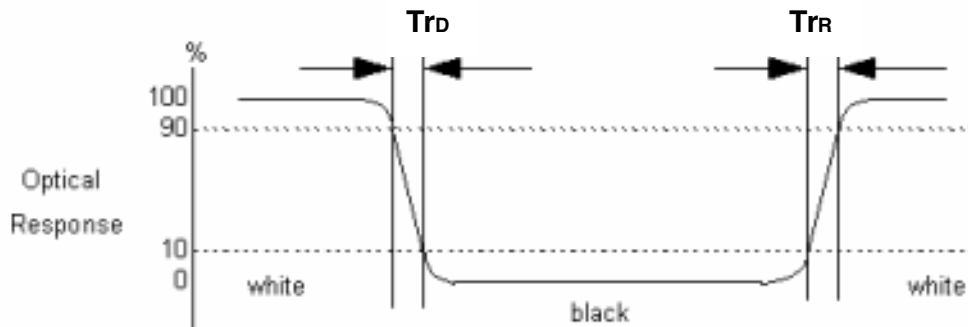

**Fig.4-2 Optical measurement point**

3. The variation in surface luminance,  $\delta$  WHITE is defined (center of Screen) as:

$$\delta \text{ WHITE(9P)} = \text{Maximum}(L_{on1}, L_{on2}, \dots, L_{on9}) / \text{Minimum}(L_{on1}, L_{on2}, \dots, L_{on9})$$

4. Response time is the time required for the display to transition from white(L255) to black(L0) (Decay Time,  $T_{rD} = T_f$ ) and from black(L0) to white(L255) (Rise Time,  $T_{rR} = T_r$ ). The response time interval is between the 10% and 90% of 1<sup>st</sup> frame amplitudes. For additional information see FIG 4-3.



**Fig.4-3 Response time**

5. Viewing angle is the angle at which the contrast ratio is greater than 10. The angles are determined for the horizontal or x axis and the vertical or y axis with respect to the z axis which is normal to the LCD surface. For more information see FIG 4-5.
6. To be measured with a viewing cone of  $1^\circ$  by Topcon luminance meter ELDIM EZ Contrast 160D.

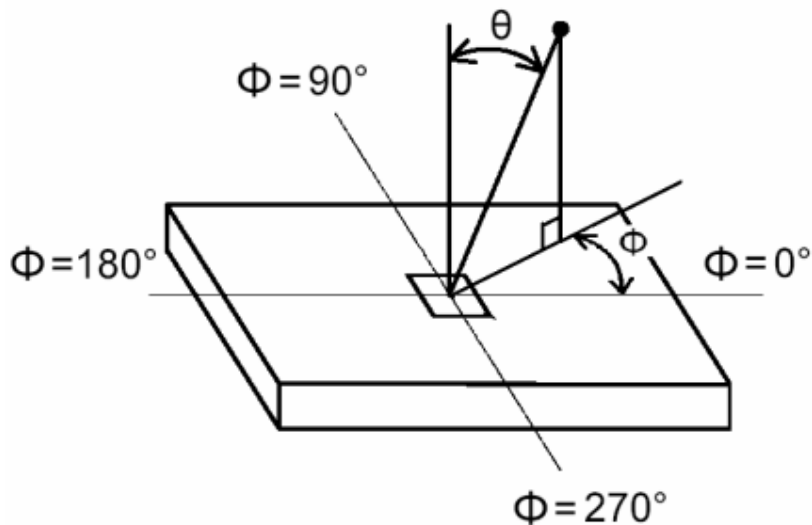

**Fig.4-5 Viewing Angle Definition**



## 5. Mechanical Characteristics

The contents provide general mechanical characteristics for the model T230XW01. In addition the figures in the next page are detailed mechanical drawing of the LCD.

Outline Dimension	Horizontal (typ.)	546.0mm
	Vertical (typ.)	318.3mm
	Depth (typ.)	46.0mm(Max.)
Bezel Area	Horizontal (typ.)	512.2mm
	Vertical (typ.)	289.8mm
Active Display Area	Horizontal	508.152mm
	Vertical	285.696mm
Weight	3300g (typ.)	
Surface Treatment	HC, 3H	



Front View:

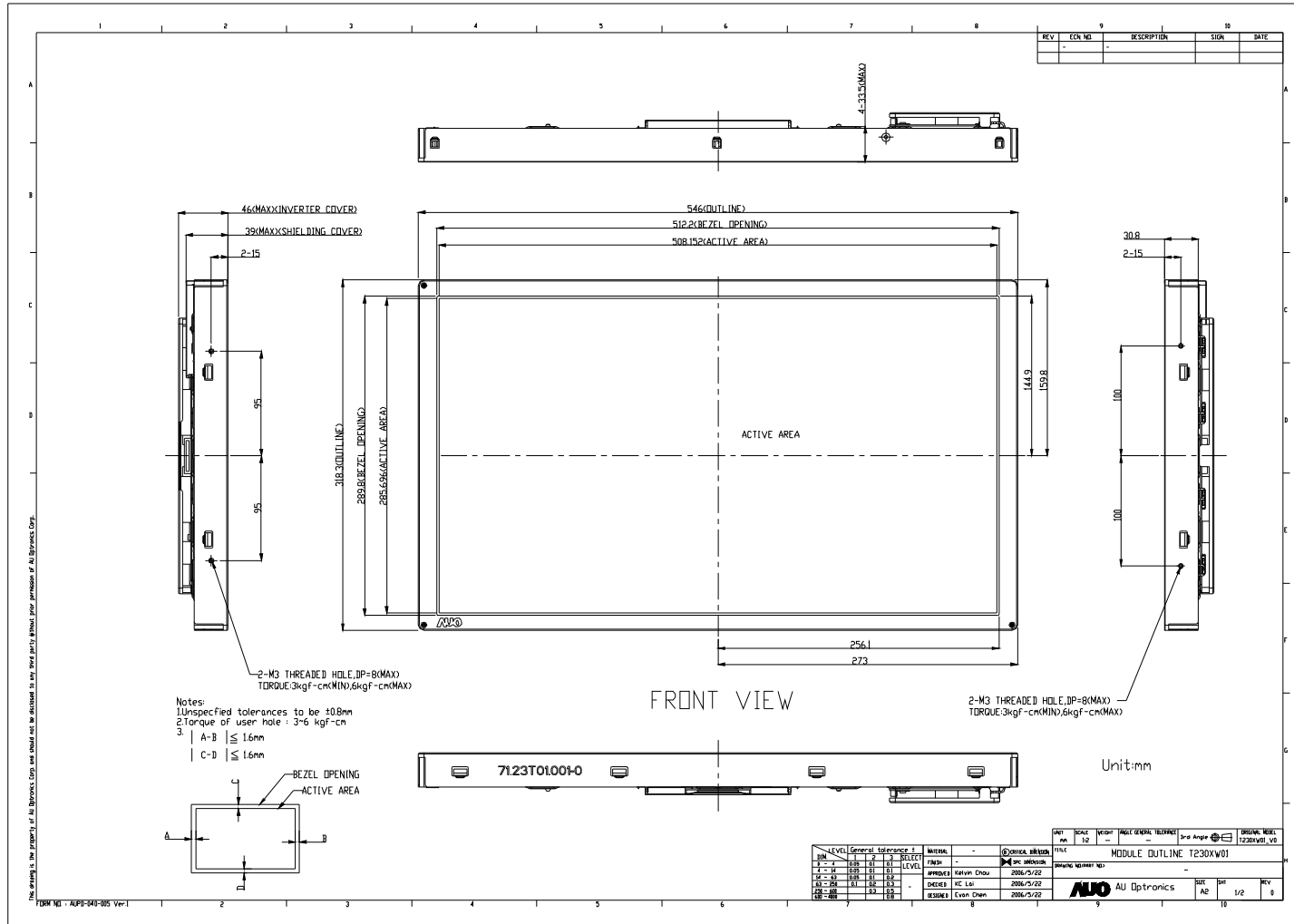



Rear View:

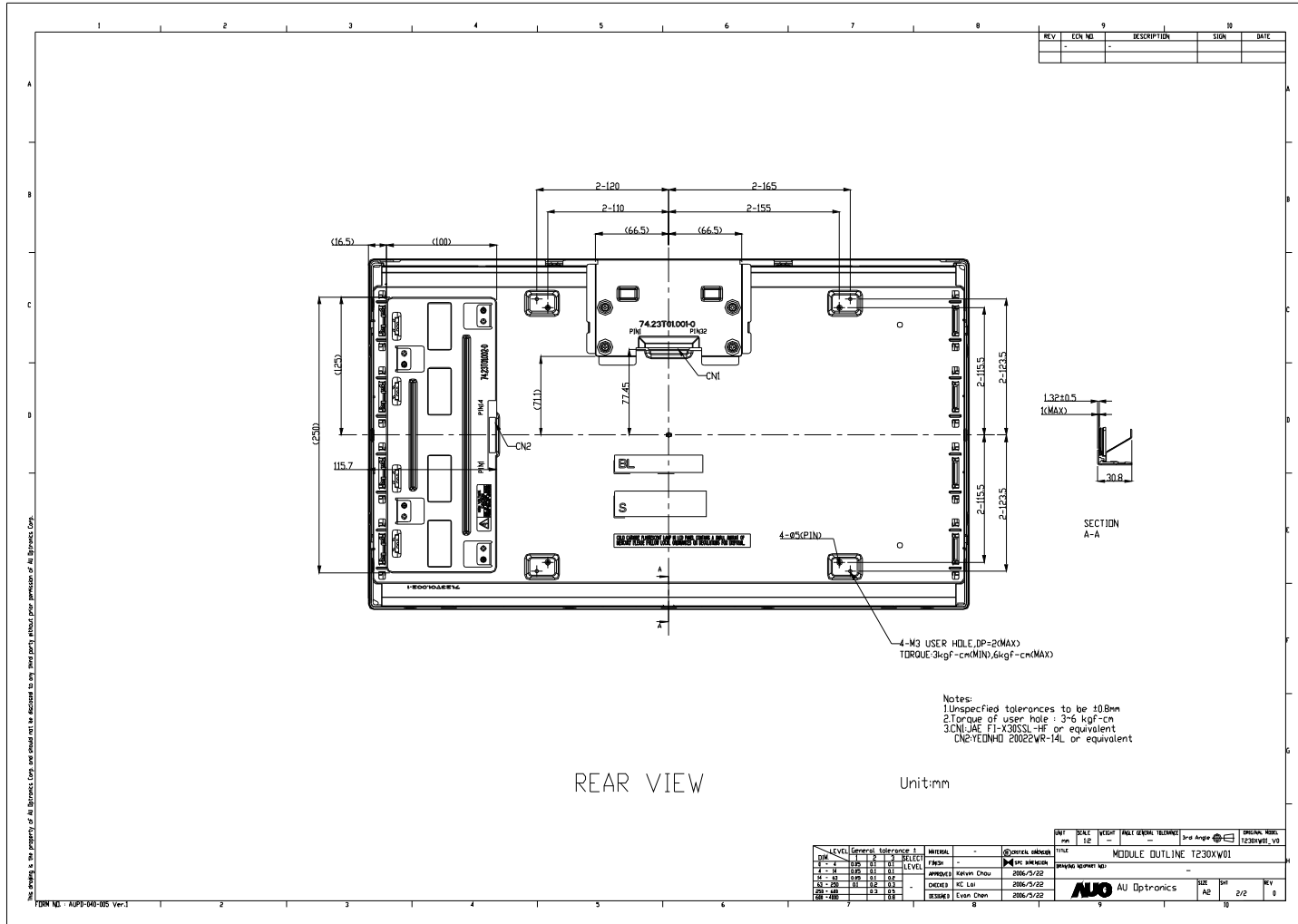



## 6. International Standard

### 6-1. Safety

- (1) UL6500, Underwriters Laboratories, Inc. (AUO file number : E204356)  
Standard for Safety of Information Technology Equipment Including electrical Business Equipment.
- (2) CAN/CSA C22.2 No. 950-95 Third Edition, Canadian Standards Association, Jan. 28, 1995  
Standard for Safety of Information Technology Equipment Including Electrical Business Equipment.
- (3) EN60950 : 1992+A2: 1993+A2: 1993+C3: 1995+A4: 1997+A11: 1997  
IEC 950: 1991+A1: 1992+A2: 1993+C3: 1995+A4:1996  
IEC 60065  
European Committee for Electro technical Standardization (CENELEC)  
EUROPEAN STANDARD for Safety of Information Technology Equipment Including Electrical Business Equipment.

### 6-2. EMC

- a) ANSI C63.4 "Methods of Measurement of Radio-Noise Emissions from Low-Voltage Electrical and Electrical Equipment in the Range of 9kHz to 40GHz. "American National standards Institute(ANSI), 1992
- b) C.I.S.P.R "Limits and Methods of Measurement of Radio Interface Characteristics of Information Technology Equipment." International Special committee on Radio Interference.
- c) EN 55022 "Limits and Methods of Measurement of Radio Interface Characteristics of Information Technology Equipment." European Committee for Electrotechnical Standardization. (CENELEC), 1998





## 7. Packing

### Label Sample

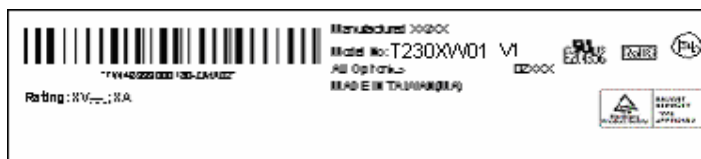

### Green Mark Description:

For Pb Free products, AUO will add  for identification.

For RoHS compatible products, AUO will add  for identification.

**Note.** The Green Mark will be present only when the green documents have been ready by AUO Internal Green Team. (The definition of green design follows the AUO green design checklist.)

### Carton Label

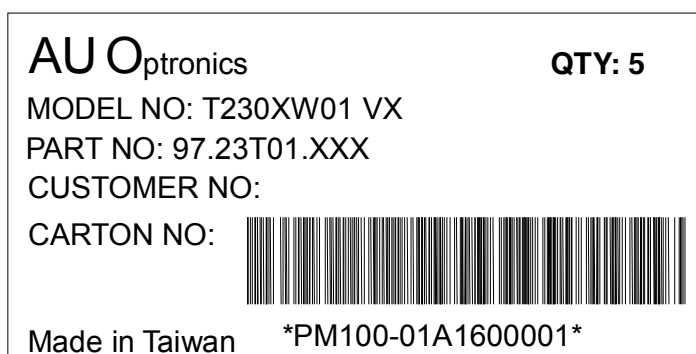

### Packing size:

Carton Box: 370mm(W)x400mm(L)x655mm(H)

Pallet Size: 1140mm(W)\*820mm(L)\*123mm(H)

### Shipping volume per pallet:

**By Air:** (3\*2)\*2 layers,  
one pallet put 12 boxes,  
total 60ps module.

**By Sea:** (3\*2)\*3 layers,  
one pallet put 18 boxes,  
total 90ps module.

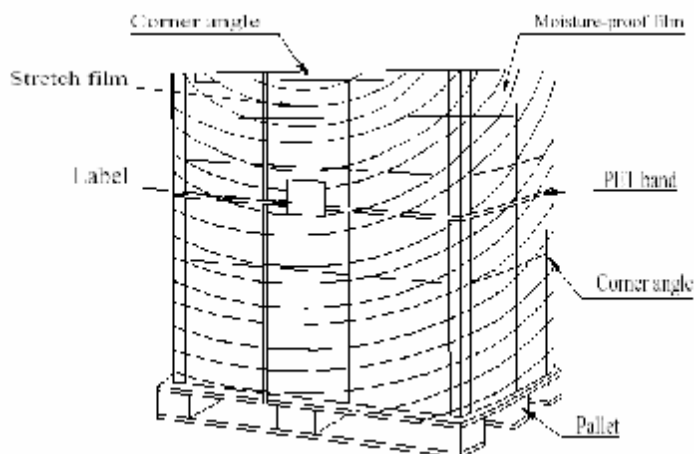



# Packing process

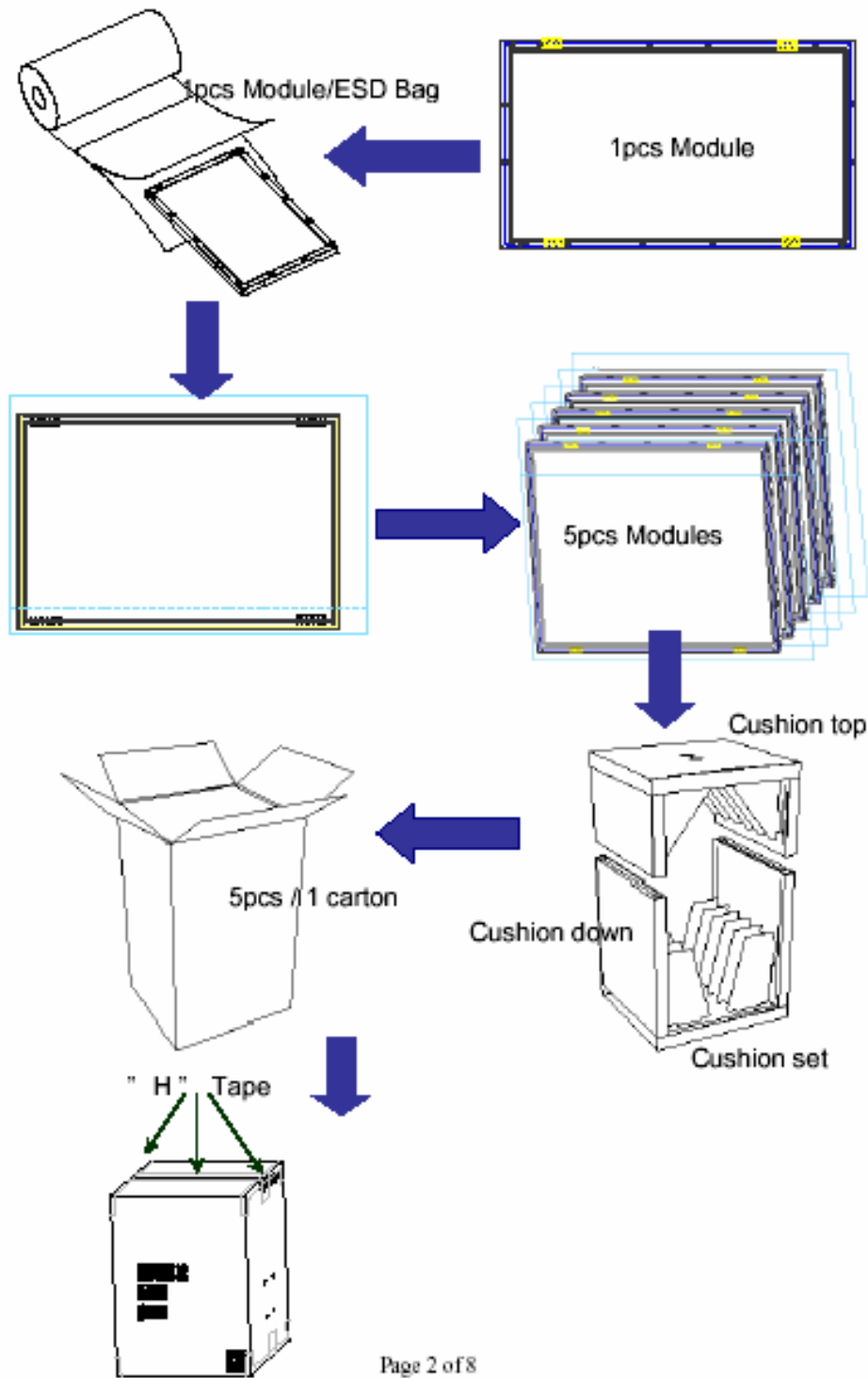



## 8. PRECAUTIONS

Please pay attention to the followings when you use this TFT LCD module.

### 8-1 MOUNTING PRECAUTIONS

- (1) You must mount a module using holes arranged in four corners or four sides.
- (2) You should consider the mounting structure so that uneven force (ex. Twisted stress) is not applied to module. And the case on which a module is mounted should have sufficient strength so that external force is not transmitted directly to the module.
- (3) Please attach the surface transparent protective plate to the surface in order to protect the polarizer. Transparent protective plate should have sufficient strength in order to resist external force.
- (4) You should adopt radiation structure to satisfy the temperature specification.
- (5) Acetic acid type and chlorine type materials for the cover case are not desirable because the former generates corrosive gas of attacking the polarizer at high temperature and the latter causes circuit break by electro-chemical reaction.
- (6) Do not touch, push or rub the exposed polarizers with glass, tweezers or anything harder than HB pencil lead. And please do not rub with dust clothes with chemical treatment. Do not touch the surface of polarizer for bare hand or greasy cloth. (Some cosmetics are detrimental to the polarizer.)
- (7) When the surface becomes dusty, please wipe gently with absorbent cotton or other soft materials like chamois soaks with petroleum benzene. Normal-hexane is recommended for cleaning the adhesives used to attach front/ rear polarizers. Do not use acetone, toluene and alcohol because they cause chemical damage to the polarizer.
- (8) Wipe off saliva or water drops as soon as possible. Their long time contact with polarizer causes deformations and color fading.
- (9) Do not open the case because inside circuits do not have sufficient strength.

### 8-2 OPERATING PRECAUTIONS

- (1) The spike noise causes the mis-operation of circuits. It should be lower than following voltage:  $V = \pm 200\text{mV}$  (Over and under shoot voltage)
- (2) Response time depends on the temperature. (In lower temperature, it becomes longer..)
- (3) Brightness depends on the temperature. (In lower temperature, it becomes lower.) And in lower temperature, response time (required time that brightness is stable after turned on) becomes longer.



- (4) Be careful for condensation at sudden temperature change. Condensation makes damage to polarizer or electrical contacted parts. And after fading condensation, smear or spot will occur.
- (5) When fixed patterns are displayed for a long time, remnant image is likely to occur.
- (6) Module has high frequency circuits. Sufficient suppression to the electromagnetic interference shall be done by system manufacturers. Grounding and shielding methods may be important to minimize the interface.

### **8-3 ELECTROSTATIC DISCHARGE CONTROL**

Since a module is composed of electronic circuits, it is not strong to electrostatic discharge. Make certain that treatment persons are connected to ground through wrist band etc. And don't touch interface pin directly.

### **8-4 PRECAUTIONS FOR STRONG LIGHT EXPOSURE**

Strong light exposure causes degradation of polarizer and color filter.

### **8-5 STORAGE**

When storing modules as spares for a long time, the following precautions are necessary.

- (1) Store them in a dark place. Do not expose the module to sunlight or fluorescent light. Keep the temperature between 5°C and 35°C at normal humidity.
- (2) The polarizer surface should not come in contact with any other object. It is recommended that they be stored in the container in which they were shipped.

### **8-6 HANDLING PRECAUTIONS FOR PROTECTION FILM**

- (1) The protection film is attached to the bezel with a small masking tape. When the protection film is peeled off, static electricity is generated between the film and polarizer. This should be peeled off slowly and carefully by people who are electrically grounded and with well ion-blown equipment or in such a condition, etc.
- (2) When the module with protection film attached is stored for a long time, sometimes there remains a very small amount of glue still on the Bezel after the protection film is peeled off.
- (3) You can remove the glue easily. When the glue remains on the Bezel or its vestige is recognized, please wipe them off with absorbent cotton waste or other soft material like chamois soaked with normal-hexane.