



Document Version: 1.3

Date:2006/3/15

Product Functional Specification

**42" WXGA Color TFT-LCD Module
Model Name: T420XW01 V0**

**(*) Preliminary Specification
() Final Specification**

Note : This specification is subject to change without notice.



Contents

No	ITEM
	COVER
	CONTENTS
	RECORD OF REVISIONS
1	GENERAL DESCRIPTION
2	ABSOLUTE MAXIMUM RATINGS
3	ELECTRICAL SPECIFICATIONS
3-1	ELECTRICAL CHARACTERISTICS
3-2	INTERFACE CONNECTIONS
3-3	SIGNAL TIMING SPECIFICATIONS
3-4	SIGNAL TIMING WAVEFORMS
3-5	COLOR INPUT DATA REFERENCE
3-6	POWER SEQUENCE
4	OPTICAL SPECIFICATIONS
5	MECHANICAL CHARACTERISTICS
6	INTERNATIONAL STANDARDS
6-1	SAFETY
6-2	EMC
7	PACKING
8	PRECAUTIONS



Record of Revision

Version	Date	No	Old Description	New Description	Remark
1.0	2005 12/23		First release		
1.1	2006 1/12		V _{ddB}	V _{DDB}	p.5
			V _{ICM}	V _{CIM}	p.6/p.7
			RIN1+/RIN1- : G6	RIN1+/RIN1- : G7	p.9
			Input current condition : Max. Brightness	Input current condition : DimmingMax.	p.10
			External PWM Control Min. Current condition : PWM=100%	External PWM Control Min. Current condition : PWM=30%	p.10
1.2	2006 2/15		BLU Brightness Control Voltage : 6.0V (Max)	BLU Brightness Control Voltage : 5.5V (Max)	p. 6
			Power Supply Input Voltage : 10.8V (min), 13.2V (max)	Power Supply Input Voltage : 11.4V (min), 12.6V (max)	p. 7
			Power Supply Input Current : TBD	Power Supply Input Current : 0.75A	p. 7
			Power Consumption : TBD	Power Consumption : 9W	p. 7
			Backlight Power Consumption : (170W)	Backlight Power Consumption : (174W)	p. 7
			Input Current : TBD	Input Current : 6.935(min), 7.3(typ), 7.66(max)	p. 11
			Input Power : TBD	Input Power : (174W)	p. 11
			ON/OFF Control Voltage : 0.7V (max)	ON/OFF Control Voltage : 0.8V (max)	p. 11
			ON/OFF Control Current : TBD	ON/OFF Control Current : 150mA (min)	
			External PWM Control Voltage : 0.7V (max)	External PWM Control Voltage : 0.8V (max)	p. 11
			External PWM Control Current (PWM 100%) : TBD	External PWM Control Current (PWM 100%) : 150mA (min)	p. 11
			External PWM Control Current (PWM 30%) : TBD	External PWM Control Current (PWM 30%) : 150mA (min)	p. 11
			Pin 12 : V _{DIM} (A _{DIM}) : High (3.3V) 120%	Pin 12 : V _{DIM} (A _{DIM}) : High (3.3V) 110%	p. 12



							Vertical Frequency Range A							p. 14					
			Signal	Item	Symbol	Min	Type	Max	Unit	Signal	Item	Symbol	Min	Type	Max	Unit			
		Vertical Section	Period	Tv	789			822	Th	Vertical Section	Period	Tv	789		822	Th			
				Active	Tdisp (v)	—	768	—	Th			Active	Tdisp (v)	—	768	—	Th		
					Blanking	Tblk (v)	21		54				Th	Blanking	Tblk (v)	21		54	Th
		Horizontal Section	Period	Th		1414			1722	Tclk	Horizontal Section	Period	Th		1414		1722	Tclk	
				Active	Tdisp (h)	—	1366	—	Tclk	Active			Tdisp (h)	—	1366	—	Tclk		
					Blanking	Tblk (h)	48		356				Tclk	Blanking	Tblk (h)	48		356	Tclk
		Clock	Period	CLK		—	—	18.18	ns	Clock	Period	CLK	11.36		—	15.38	ns		
				Frequency	Freq	55		88	MHz			Frequency	Freq	65		88	MHz		
		Vertical Frequency	Frequency		Vs	58	60	62	Hz	Vertical Frequency	Frequency		Vs	58	60	62	Hz		
			Horizontal Frequency	Frequency	Hs	45.76		50.96	KHz	Horizontal Frequency	Frequency	Hs	45.76		50.96	KHz			
										Vertical Frequency Range B									
		Vertical Frequency	Frequency	Hs	58	60	62	Hz	Vertical Section	Period	Tv	789		822	Th				
				Horizontal Frequency	Frequency	Hs	47.34				49.32	KHz	Active	Tdisp (v)	—	768	—	Th	
						Vertical Frequency	Frequency	Vs			48	50		52	Hz	Blanking	Tblk (v)	21	
		Horizontal Frequency	Frequency	Hs	39.45				41.1	KHz	Period	Th	1414		1722		Tclk		
				Vertical Frequency	Frequency	Vs	48	50	52	Hz		Active	Tdisp (h)	—	1366	—	Tclk		
		Horizontal Frequency	Frequency			Hs	37.87		42.74	KHz	Blanking		Tblk (h)	48		356	Tclk		
				Clock	Period	CLK	13.51	—	18.52	ns		Period	CLK	13.51	—	18.52	ns		
		Frequency	Frequency			Freq	54		74	MHz	Frequency		Freq	54		74	MHz		
				Vertical Frequency	Frequency	Vs	48	50	52	Hz		Vertical Frequency	Frequency	Vs	48	50	52	Hz	
			Horizontal Frequency	Frequency	Hs	37.87		42.74	KHz	Horizontal Frequency	Frequency	Hs	37.87		42.74	KHz			
		2D drawing : Old rear mount dimension 44.1mm	2D drawing : New rear mount dimension 40.5mm							p. 23									
			Add packing description							p. 25									
1.3	2006/3/15	Outline Dimension : 983.0(H) x 576.0(V) x 54.2(D)	Outline Dimension : 983.0(H) x 576.0(V) x 52.7(D)							p. 6									
		Inrush current : TBD (Max)	Inrush current : 5A (Max)							p. 8									
		Backlight Power Consumption : (174)W	Backlight Power Consumption : 175W(typ), 182W(max)							p. 8									
		Input Power (P _{DDB}) : (174)W	Input Power (P _{DDB}) : 175W							p. 12									
		Input inrush current (I _{RUSH}) : (1	Input inrush current (I _{RUSH}) : 12A(max)							p. 12									



		2)A(max)		
		ON/OFF Control Current (I_{BLON}) : 150mA(min)	ON/OFF Control Current (I_{BLON}) : 0mA(min), 2mA(max)	p. 12
		External PWM Control Current (I_{PWM}) : 150mA(min)	External PWM Control Current (I_{PWM}) : 0mA(min), 2mA(max)	p. 12
		External PWM Frequency (E_{PWM}) : 120Hz(min)	External PWM Frequency (E_{PWM}) : 150Hz(min)	p. 12
		Contrast Ratio : (1200)typ	Contrast Ratio : 1000(min), 1200(typ)	p. 20
		Response Time (T_r) : (15)ms	Response Time (T_r) : 15ms(typ)	p. 20
		Response Time (T_f) : (5)ms	Response Time (T_f) : 5ms(typ)	p. 20
		Outline Dimension Depth : 54.2mm (with inverter)	Outline Dimension Depth : 52.7mm (with inverter)	p. 23
		Bezel Area, Horizontal (typ.) : 938.3mm	Bezel Area, Horizontal (typ.) : 939.0mm	p. 23
			Update 2D drawing	p. 24
			Add Shipping label green mark description	p. 26
			Add pallet information	p. 26



1. General Description

This specification applies to the 42 inch Color TFT-LCD Module T420XW01 V0. This LCD module has a TFT active matrix type liquid crystal panel 1366x768 pixels, and diagonal size of 42 inch. This module supports 1366x768 WXGA mode (Non-interlace).

Each pixel is divided into Red, Green and Blue sub-pixels or dots which are arranged in vertical stripes. Gray scale or the brightness of the sub-pixel color is determined with a 8-bit gray scale signal for each dot.

The T420XW01 V0 has been designed to apply the 8-bit 1 channel LVDS interface method. It is intended to support displays where high brightness, wide viewing angle, high color saturation, and high color depth are very important.

* General Information

Items	Specification	Unit	Note
Active Screen Size	42.02	inches	
Display Area	930.25(H) x 523.01(V)	mm	
Outline Dimension	983.0(H) x 576.0(V) x 52.7(D)	mm	With inverter
Driver Element	a-Si TFT active matrix		
Display Colors	16.7M	Colors	
Number of Pixels	1366 x 768	Pixel	
Pixel Arrangement	RGB vertical stripe		
Display Mode	Normally Black		
Surface Treatment	AG, 3H		



2. Absolute Maximum Ratings

The following are maximum values which, if exceeded, may cause faulty operation or damage to the unit.

Item	Symbol	Min	Max	Unit	Note
Logic/LCD Drive Voltage	V _{DD}	-0.3	14.0	[Volt]	1
Input Voltage of Signal	V _{in}	-0.3	3.6	[Volt]	1
BLU Input Voltage	V _{DDB}	-0.3	27.0	[Volt]	1
BLU Brightness Control Voltage	BLON	-0.3	5.5	[Volt]	1
Operating Temperature	T _{OP}	0	+50	[°C]	2
Operating Humidity	H _{OP}	10	90	[%RH]	2
Storage Temperature	T _{ST}	-20	+60	[°C]	2
Storage Humidity	H _{ST}	10	90	[%RH]	2
Shock (non-operation)		-	50	G	3
Vibration (non-operation)		-	1.5	G	4
Thermal shock		-20	60	C	5
Altitude test	50000feet (12Kpa)				

Note 1 : Duration = 50msec

Note 2 : Maximum Wet-Bulb should be 39 °C and No condensation.

Note 3 : Half sine wave, shock level : 50G(11ms), direction : ±x, ±y, ±z (one time each direction)

Note 4 : Wave form : random, vibration level : 1.5G RMS, Bandwidth : 10--300Hz

Duration : X,Y,Z 30min (one time each direction)

Note 5 : -20C/0.5hr ~ 60C/0.5hr, 10 cycles

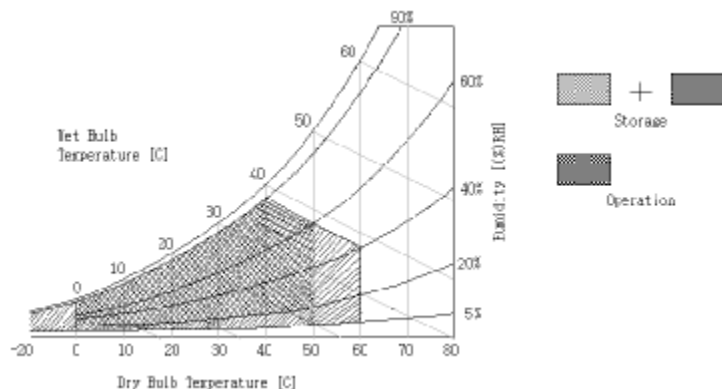



3. Electrical Specification

The T420XW01 requires two power inputs. One is employed to power the LCD electronics and to drive the TFT array and liquid crystal. The second input, which powers the CCFL, is typically generated by an inverter.

3-1 Electrical Characteristics

Parameter		Symbol	Values			Unit	Notes
			Min	Typ	Max		
LCD:							
Power Supply Input Voltage		Vdd	11.4	12	12.6	Vdc	
Power Supply Input Current		Idd	-	0.75	-	A	1
Power Consumption		Pc	-	9	-	Watt	1
Inrush Current		I _{RUSH}	-	-	5	A	5
LVDS Interface	Differential Input High Threshold Voltage	V _{TH}			+100	mV	4
	Differential Input Low Threshold Voltage	V _{TL}	-100			mV	4
	Common Input Voltage	V _{CIM}	1.10	1.25	1.40	V	
CMOS Interface	Input High Threshold Voltage	V _{IH} (High)	2.4		3.3	Vdc	
	Input Low Threshold Voltage	V _{IL} (Low)	0		0.7	Vdc	
Backlight Power Consumption			-	174	182	Watt	2
Life Time			50000	60000		Hours	3

The performance of the Lamp in LCM, for example life time or brightness, is extremely influenced by the characteristics of the DC-AC Inverter. So all the parameters of an inverter should be carefully designed so as not to produce too much leakage current from high-voltage output of the inverter. When you design or order the inverter, please make sure unwanted lighting caused by the mismatch of the lamp and the inverter (no lighting, flicker, etc) never occurs. When you

confirm it, the LCD Assembly should be operated in the same condition as installed in your instrument.

Do not attach a conducting tape to lamp connecting wire. If the lamp wire attach to conducting tape, TFT-LCD Module have a low luminance and the inverter has abnormal action because leakage current occurs between lamp wire and conducting tape.

The relative humidity must not exceed 80% non-condensing at temperatures of 40 °C or less. At temperatures greater than 40 °C, the wet bulb temperature must not exceed 39 °C. When operate at low temperatures, the brightness of CCFL will drop and the lifetime of CCFL will be reduced.

Note :

1. Vdd=12.0V, fv=60Hz, f_{CLK}=81.5 Mhz , 25°C, Vdd Duration time= 400 μs , Test pattern : white pattern
2. The Backlight power consumption shown above does include loss of external inverter at 25 °C. The used lamp current is the lamp typical current
3. The life is determined as the time at which luminance of the lamp is 50% compared to that of initial value at the typical lamp current on condition of continuous operating at 25 ±2°C.
4. VCIM = 1.2V

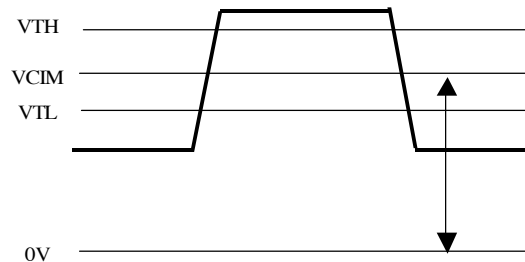
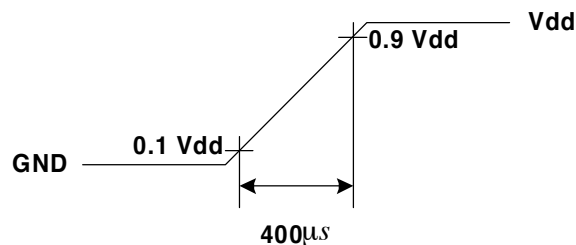

Figure : LVDS Differential Voltage

5. Measurement Condition: Rising time = 400 μs





3-2 Interface Connections

- LCD connector: FI-X30SSL-HF (JAE) or equivalent
- Mating connector: FI-30C2L (JAE) or equivalent

Pin No	Symbol	Description	Note
1	VCC	+12V, DC, Regulated	
2	VCC	+12V, DC, Regulated	
3	VCC	+12V, DC, Regulated	
4	VCC	+12V, DC, Regulated	
5	GND	Ground and Signal Return	
6	GND	Ground and Signal Return	
7	GND	Ground and Signal Return	
8	GND	Ground and Signal Return	
9	LVDS Option	Low/Open for Normal (NS), High for JEIDA	Default : NS mode
10	Reserved	Open or High	AUO internal test
11	GND	Ground and Signal Return for LVDS	
12	RXIN0-	LVDS Channel 0 negative	
13	RXIN0+	LVDS Channel 0 positive	
14	GND	Ground and Signal Return for LVDS	
15	RXIN1-	LVDS Channel 1 negative	
16	RXIN1+	LVDS Channel 1 positive	
17	GND	Ground and Signal Return for LVDS	
18	RXIN2-	LVDS Channel 2 negative	
19	RXIN2+	LVDS Channel 2 positive	
20	GND	Ground and Signal Return for LVDS	
21	RXCLKIN-	LVDS Clock negative	
22	RXCLKIN+	LVDS Clock positive	
23	GND	Ground and Signal Return for LVDS	
24	RXIN3-	LVDS Channel 3 negative	
25	RXIN3+	LVDS Channel 3 positive	
26	GND	Ground and Signal Return for LVDS	
27	Reserved	Open or High	AUO internal test
28	Reserved	Open or High	AUO internal test
29	GND	Ground and Signal Return	
30	GND	Ground and Signal Return	



LVDS Option = High & JEIDA

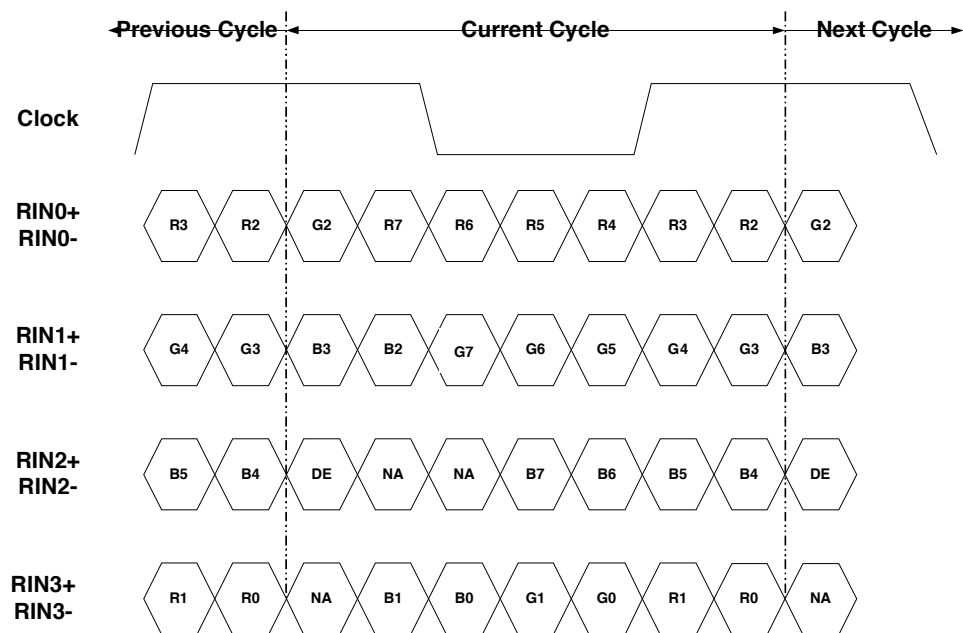

LVDS Option = Low/OPEN & NS

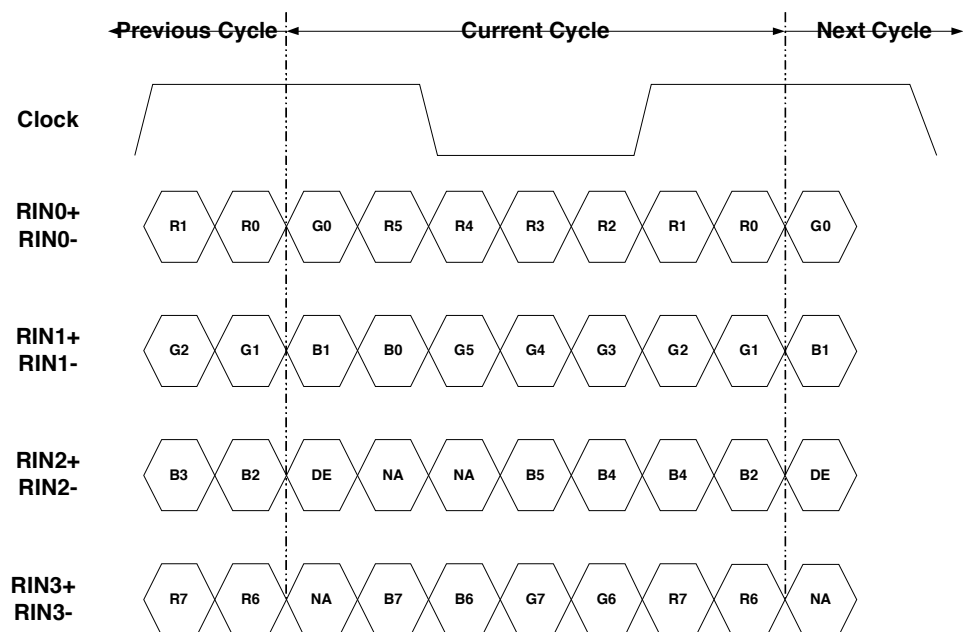



Backlight Connector Pin Configuration

1. Electrical specification

No	ITEM	SYMBOL	CONDITION	MIN	TYP	MAX	UNIT	Note	
1	Input Voltage	V_{DDB}	---	22.8	24.0	26.4	V_{DC}		
2	Input Current	I_{DDB}	$V_{DDB}=24V$ 100% Brightness	6.935	7.3	7.66	A_{DC}	1	
3	Input Power	P_{DDB}	$V_{DDB}=24V$ 100% Brightness	---	175	---	W	1	
4	Input inrush current	I_{RUSH}	$V_{DDB}=24V$ 100% Brightness	---	---	12	A_{DC}	2	
5	Output Frequency	F_{BL}	$V_{DDB}=24V$	---	58	---	kHz		
6	ON/OFF Control Voltage	V_{BLON}	ON	$V_{DDB}=24V$	2.0	---	3.3	V_{DC}	
			OFF	$V_{DDB}=24V$	0.0	---	0.8	V_{DC}	
7	ON/OFF Control Current	I_{BLON}	$V_{DDB}=24V$	0	---	2	mA_{DC}		
8	External PWM Control Voltage	E_{PWM}	MAX	---	2.0	---	3.3	V_{DC}	
			MIN	---	0	---	0.8	V_{DC}	
9	External PWM Control Current	E_{IPWM}	MAX	PWM=100%	0	---	2	mA_{DC}	
			MIN	PWM=30%	0	---	2	mA_{DC}	
10	External PWM Duty Ratio	E_{DPWM}	---	30	---	100	%		
11	External PWM Frequency	E_{FPWM}	---	150	180	300	Hz		

($T_a=25\pm 5^{\circ}C$, Turn on for 45minutes)

Note 1 : $V_{DIM}/Open = 1.6V$; $P_{DIM} = Open/High$

Note 2 : Duration = 20 ms



2. Input specification

Master Board:

Connector 1: S14B-PH-SM3-TB(JST) or equivalent

Pin No	Symbol	Description
1	VDDB	Operating Voltage Supply, +24V DC regulated
2	VDDB	Operating Voltage Supply, +24V DC regulated
3	VDDB	Operating Voltage Supply, +24V DC regulated
4	VDDB	Operating Voltage Supply, +24V DC regulated
5	VDDB	Operating Voltage Supply, +24V DC regulated
6	BLGND	Ground and Current Return
7	BLGND	Ground and Current Return
8	BLGND	Ground and Current Return
9	BLGND	Ground and Current Return
10	BLGND	Ground and Current Return
11	VDIM (ADIM) ⁽¹⁾	GND: 80%; Open/1.6V: 100%; High (3.3V) 110%, Luminance
12	VBLON	BL On-Off: Open/High (3.3V) for BL On as default
13	PDIM ⁽²⁾	External PWM/Analog Dimming Control input; Open/High (3.3V, 100% Duty) for 100%
14	PDIM Selection ⁽³⁾	GND: External PWM dimming; Open/High: Analog dimming.

Note (1) VDIM is control signal for Inverter's output Power to Back Light Lamp Bulb. Input Signal should be able to control Amplitude of Inverter Output voltage. From 0V to 3.3V, Inverter Output Voltage should be able to vary to control Brightness of Lamp from 80% to 110% Luminescence variation. Approx. 1.6V might be 100% Luminance control point.

Note (2) PDIM is PWM duty control Input for +3.3V TTL Level Signal. This Input Signal is Continuous Pulse Signal with +3.3V, TTL Level Signal Spec. If this is Open or +3.3V, 100% Duty (i.e. +3.3V, DC level), Back Light should perform 100% Luminance. Duty Ratio of this Input signal should be proportional relationship in certain range of control without any kind of inherent side effect like Waterfall effect on Screen. Guaranteed Duty Range and Dimming Ratio should be specified with supplementary measurement result.

Note (3) 14 Pin is selection pin for PWM control method; if this pin is connected to GND, P DIM input of 13th Pin should have Logic Level Duty Signal for PWM control. If this is set to High or Open, 13th Pin should have DC level signal therefore the Inverter should have Saw Tooth Wave Generator to generate internal PWM signal. Default setting is "Analog", means when it is "Not Connected", 13th pin of PWM control should be have DC Level signal for PWM.



Slave Board:

Connector 2: S12B-PH-SM3-TB(JST) or equivalent

Pin No	Symbol	Description
1	VDDB	Operating Voltage Supply, +24V DC regulated
2	VDDB	Operating Voltage Supply, +24V DC regulated
3	VDDB	Operating Voltage Supply, +24V DC regulated
4	VDDB	Operating Voltage Supply, +24V DC regulated
5	VDDB	Operating Voltage Supply, +24V DC regulated
6	BLGND	Ground and Current Return
7	BLGND	Ground and Current Return
8	BLGND	Ground and Current Return
9	BLGND	Ground and Current Return
10	BLGND	Ground and Current Return
11	NC	
12	NC	



3-3 Signal Timing Specifications

This is the signal timing required at the input of the User connector. All of the interface signal timing should be satisfied with the following specifications for it's proper operation.

Timing Table (DE only Mode)

Vertical Frequency Range A (60Hz)

Signal	Item	Symbol	Min	Type	Max	Unit
Vertical Section	Period	Tv	789		822	Th
	Active	Tdisp (v)	—	768	—	Th
	Blanking	Tblk (v)	21		54	Th
Horizontal Section	Period	Th	1414		1722	Tclk
	Active	Tdisp (h)	—	1366	—	Tclk
	Blanking	Tblk (h)	48		356	Tclk
Clock	Period	CLK	11.36	—	15.38	ns
	Frequency	Freq	65		88	MHz
Vertical Frequency	Frequency	Vs	58	60	62	Hz
Horizontal Frequency	Frequency	Hs	45.76		50.96	KHz

Vertical Frequency Range B (50Hz)

Signal	Item	Symbol	Min	Type	Max	Unit
Vertical Section	Period	Tv	789		822	Th
	Active	Tdisp (v)	—	768	—	Th
	Blanking	Tblk (v)	21		54	Th
Horizontal Section	Period	Th	1414		1722	Tclk
	Active	Tdisp (h)	—	1366	—	Tclk
	Blanking	Tblk (h)	48		356	Tclk
Clock	Period	CLK	13.51	—	18.52	ns
	Frequency	Freq	54		74	MHz
Vertical Frequency	Frequency	Vs	48	50	52	Hz
Horizontal Frequency	Frequency	Hs	37.87		42.74	KHz



3-4 Signal Timing Waveforms

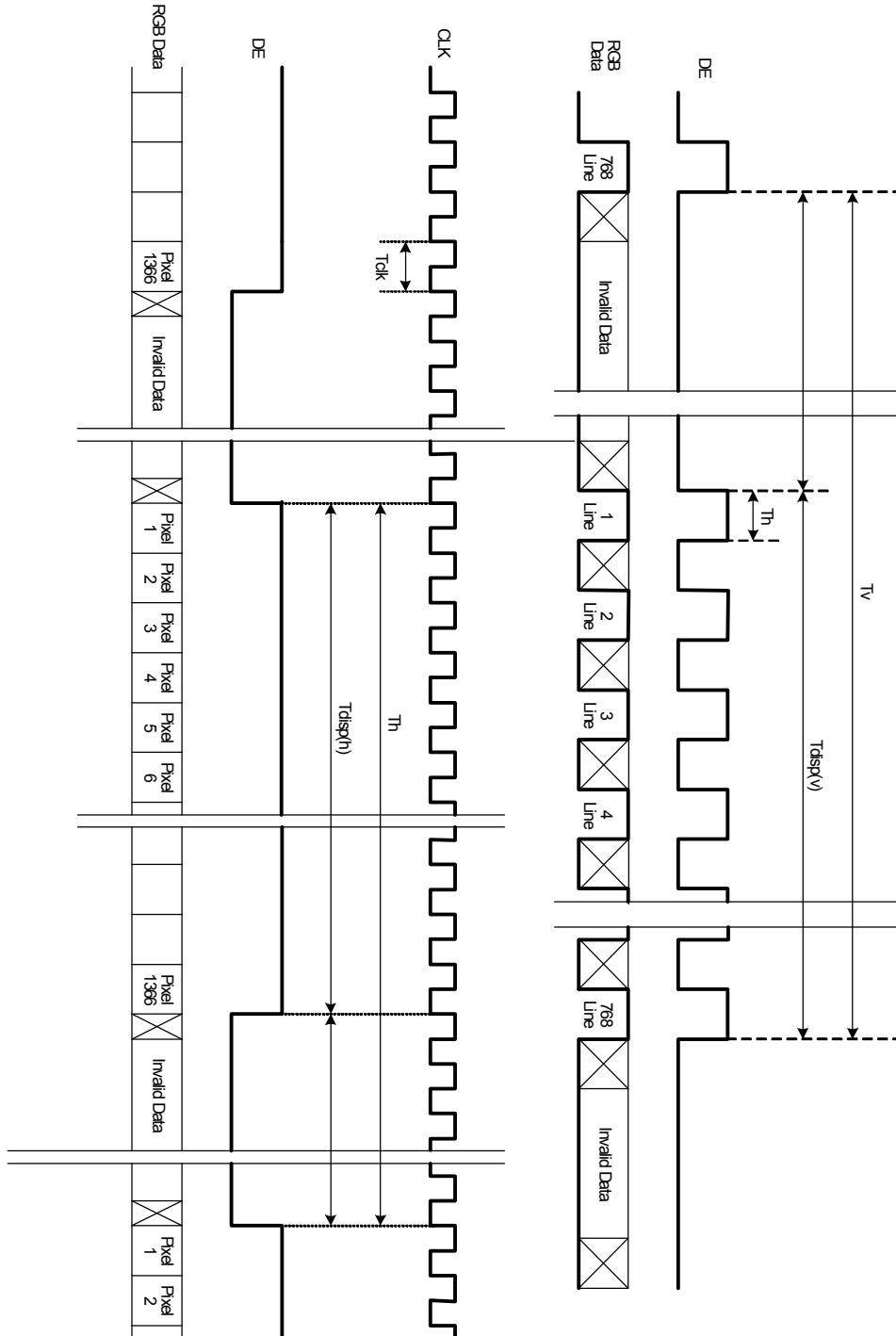



3-5 Color Input Data Reference

The brightness of each primary color (red, green and blue) is based on the 8 bit gray scale data input for the color; the higher the binary input, the brighter the color. The table below provides a reference for color versus data input.

COLOR DATA REFERENCE

Color		Input Color Data																							
		RED								GREEN								BLUE							
		MSB				LSB				MSB				LSB				MSB				LSB			
		R7	R6	R5	R4	R3	R2	R1	R0	G7	G6	G5	G4	G3	G2	G1	G0	B7	B6	B5	B4	B3	B2	B1	B0
Basic Color	Black	0	0	0	0	0	0	0	0	0	0	0	0	0	0	0	0	0	0	0	0	0	0	0	0
	Red(255)	1	1	1	1	1	1	1	1	0	0	0	0	0	0	0	0	0	0	0	0	0	0	0	0
	Green(255)	0	0	0	0	0	0	0	0	1	1	1	1	1	1	1	1	0	0	0	0	0	0	0	0
	Blue(255)	0	0	0	0	0	0	0	0	0	0	0	0	0	0	0	0	1	1	1	1	1	1	1	1
	Cyan	0	0	0	0	0	0	0	0	1	1	1	1	1	1	1	1	1	1	1	1	1	1	1	1
	Magenta	1	1	1	1	1	1	1	1	0	0	0	0	0	0	0	0	1	1	1	1	1	1	1	1
	Yellow	1	1	1	1	1	1	1	1	1	1	1	1	1	1	1	1	0	0	0	0	0	0	0	0
	White	1	1	1	1	1	1	1	1	1	1	1	1	1	1	1	1	1	1	1	1	1	1	1	1
RED	RED(000)	0	0	0	0	0	0	0	0	0	0	0	0	0	0	0	0	0	0	0	0	0	0	0	0
	RED(001)	0	0	0	0	0	0	0	1	0	0	0	0	0	0	0	0	0	0	0	0	0	0	0	0

	RED(254)	1	1	1	1	1	1	1	0	0	0	0	0	0	0	0	0	0	0	0	0	0	0	0	0
	RED(255)	1	1	1	1	1	1	1	1	0	0	0	0	0	0	0	0	0	0	0	0	0	0	0	0
GREEN	GREEN(000)	0	0	0	0	0	0	0	0	0	0	0	0	0	0	0	0	0	0	0	0	0	0	0	0
	GREEN(001)	0	0	0	0	0	0	0	0	0	0	0	0	0	0	0	1	0	0	0	0	0	0	0	0

	GREEN(254)	0	0	0	0	0	0	0	0	1	1	1	1	1	1	1	0	0	0	0	0	0	0	0	0
	GREEN(255)	0	0	0	0	0	0	0	0	1	1	1	1	1	1	1	1	0	0	0	0	0	0	0	0
BLUE	BLUE(000)	0	0	0	0	0	0	0	0	0	0	0	0	0	0	0	0	0	0	0	0	0	0	0	0
	BLUE(001)	0	0	0	0	0	0	0	0	0	0	0	0	0	0	0	0	0	0	0	0	0	0	0	1

	BLUE(254)	0	0	0	0	0	0	0	0	0	0	0	0	0	0	0	0	1	1	1	1	1	1	1	0
	BLUE(255)	0	0	0	0	0	0	0	0	0	0	0	0	0	0	0	0	1	1	1	1	1	1	1	1

3-6 Power Sequence

1. Power sequence of panel

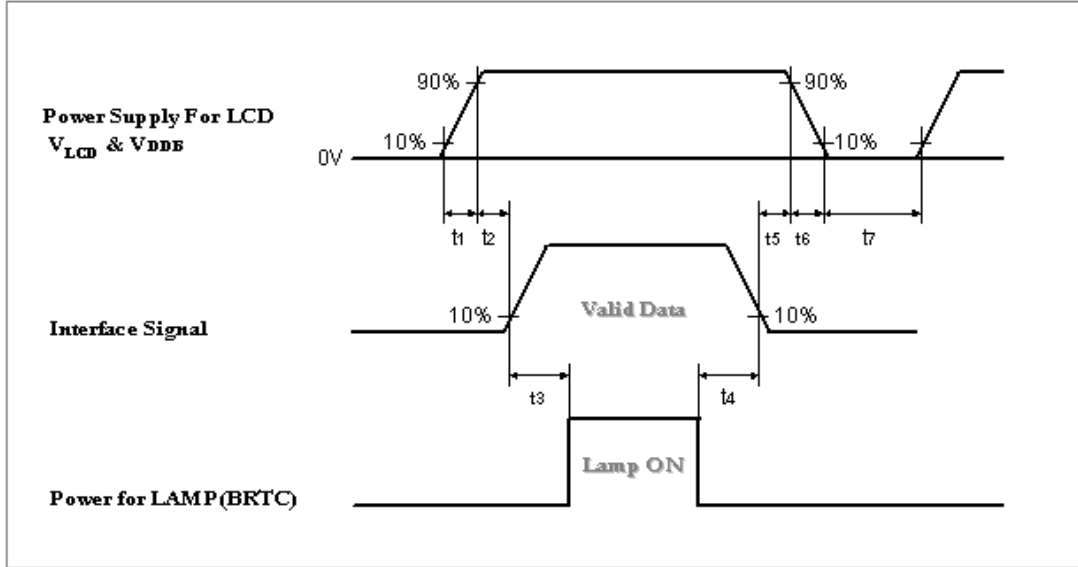

Parameter	Values			Units
	Min.	Typ.	Max.	
t1	400	-	1000	us
t2	20	-	50	ms
t3	700 or (200)*	-	-	ms
t4	200	-	-	ms
t5	50	-	-	ms
t6	0.47	-	30	ms
t7	1	-	-	s

* : If t3=200ms, input black signal till 700ms from system is necessary. In case of t3<200ms, the abnormal display will be happened. But it will not damage timing controller.

Apply the lamp voltage within the LCD operating range. When the backlight turns on before the LCD operation or the LCD turns off before the backlight turns off, the display may momentarily become abnormal.

Caution : The above on/off sequence should be applied to avoid abnormal function in the display. In case of handling, make sure to turn off the power when you plug the cable into the input connector or pull the cable out of the connector.



2. Power sequence of inverter

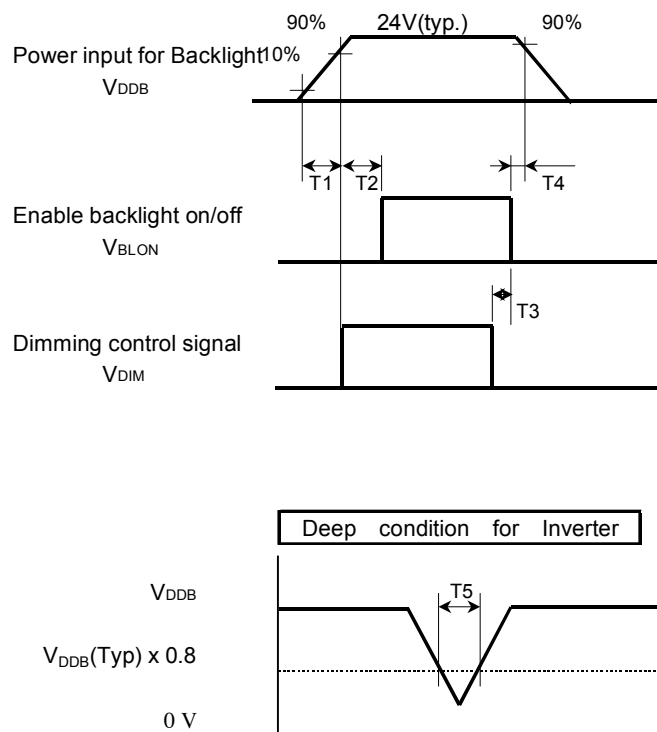

Parameter	Values			Units
	Min.	Typ.	Max.	
T1	20	-	-	ms
T2	500	-	-	ms
T3	0	-	-	ms
T4	1	-	-	ms
T5	-	-	10	ms



4. Optical Specification

Optical characteristics are determined after the unit has been 'ON' and stable for approximately 45 minutes in a dark environment at 25°C. The values specified are at an approximate distance 50cm from the LCD surface at a viewing angle of Φ and θ equal to 0°.

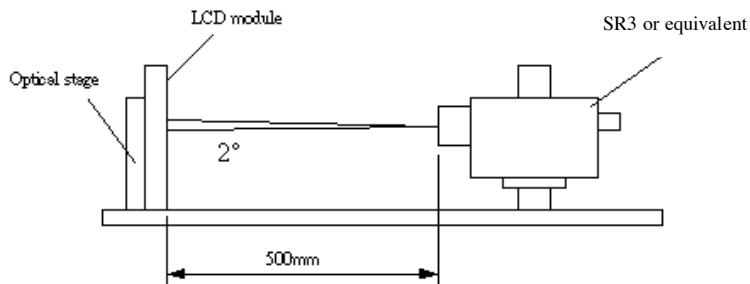

Fig.4-1 Optical measurement equipment and method

Parameter	Symbol	Values			Units	Notes
		Min.	Typ.	Max.		
Contrast Ratio	CR	1000	1200			1
Surface Luminance, white	LWH	400	500		cd/m ²	2
Luminance Variation	δ_{WHITE}	9 p		1.3		3
Response Time (Average)	T_{γ}		8		ms	4,5 (Gray to Gray)
	Rise Time		15		ms	
	Decay Time		5		ms	
Color Coordinates						
	RED	R_x		0.640		
		R_y		0.330		
	GREEN	G_x		0.270		
		G_y	Typ.-0.03	0.600	Typ.+0.03	
	BLUE	B_x		0.150		
		B_y		0.060		
	WHITE	W_x		0.280		
		W_y		0.290		
Viewing Angle						
	x axis, right ($\varphi=0^\circ$)	θ_r		89	Degree	6
	x axis, left ($\varphi=180^\circ$)	θ_l		89		
	y axis, up ($\varphi=90^\circ$)	θ_u		89		
	y axis, down ($\varphi=0^\circ$)	θ_d		89		

Note:

1. Contrast Ratio (CR) is defined mathematically as:

$$\text{Contrast ratio (CR)} = \frac{\text{Brightness on the "white" state}}{\text{Brightness on the "black" state}}$$

2. Surface luminance is luminance value at point 1 across the LCD surface 50cm from the surface with all pixels displaying white. From more information see Fig. 4-2. When $V_{DDB} = 24V$, $I_{DDB} = \text{TBD}$. $L_{WH} = L_{on1}$, Where L_{on1} is the luminance with all pixels displaying white at center 1 location.

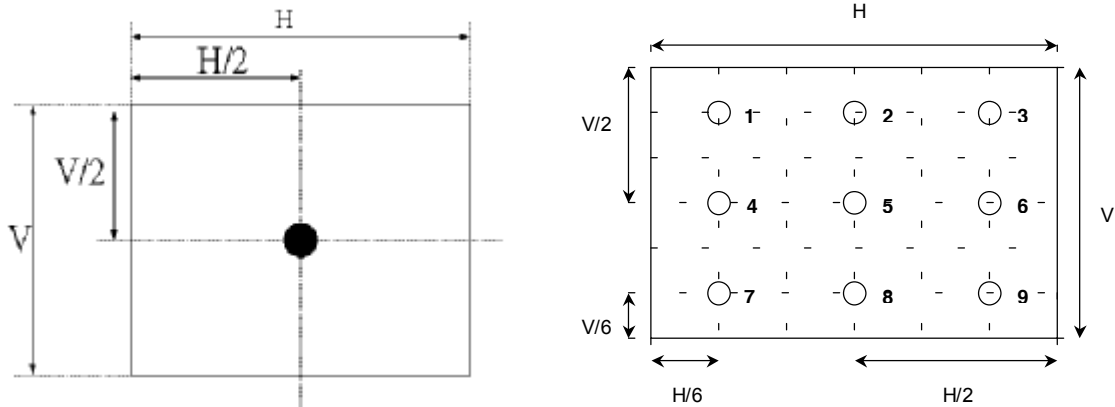

Fig.4-2 Optical measurement point

3. The variation in surface luminance, δ_{WHITE} is defined under 100% brightness as:

$$\delta_{\text{WHITE(9P)}} = \frac{\text{Maximum}(L_{on1}, L_{on2}, \dots, L_{on9})}{\text{Minimum}(L_{on1}, L_{on2}, \dots, L_{on9})}$$

4. Response time is the time required for the display to transition from white(L255) to black(L0) (Decay Time, $Tr_D = T_f$) and from black(L0) to white(L255) (Rise Time, $Tr_R = T_r$). For additional information see Fig. 4-3.

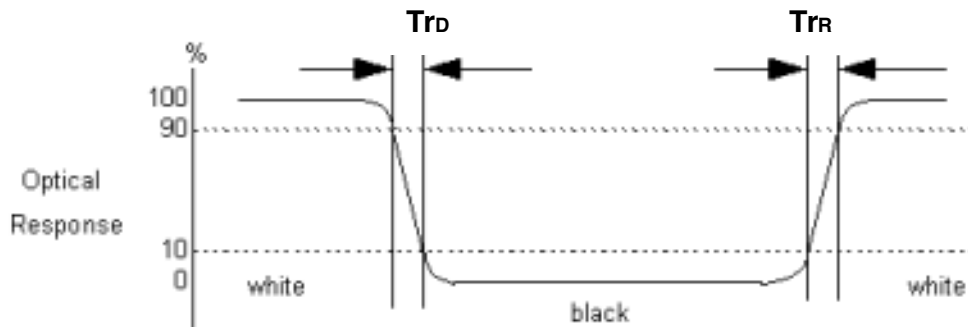

Fig.4-3 Response time

5. The response time is defined as the following figure and shall be measured by switching the input signal for 0, 63, 127, 191, 255 different gray level. For additional information see Fig. 4-4.

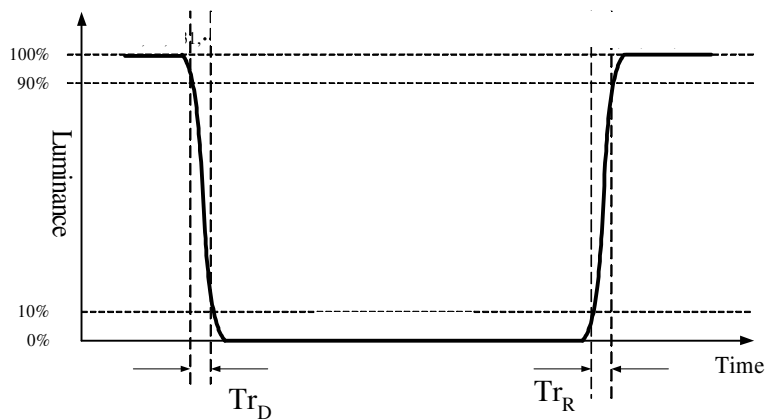

Fig.4-4 Response time

6. Viewing angle is the angle at which the contrast ratio is greater than 10. The angles are determined for the horizontal or x axis and the vertical or y axis with respect to the z axis which is normal to the LCD surface. For more information see Fig. 4-5.

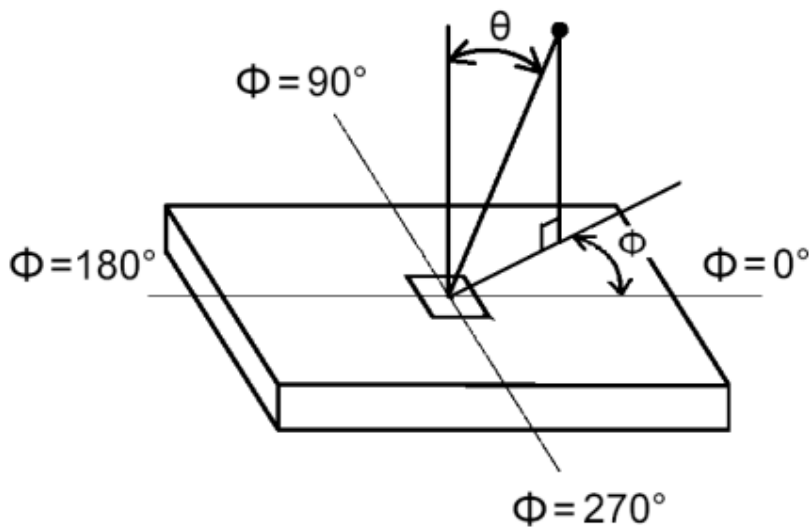

Fig.4-5 Viewing Angle Definition



5. Mechanical Characteristics

The contents provide general mechanical characteristics for the model T420XW01. In addition the figures in the next page are detailed mechanical drawing of the LCD.

Outline Dimension	Horizontal (typ.)	983.0mm
	Vertical (typ.)	576.0mm
	Depth (typ.)	52.7mm (with inverter)
Bezel Area	Horizontal (typ.)	939.0mm
	Vertical (typ.)	531.3mm
Active Display Area	Horizontal	930.25mm
	Vertical	523.01mm
Weight	15000g (typ.)	
Surface Treatment	AG, 3H	

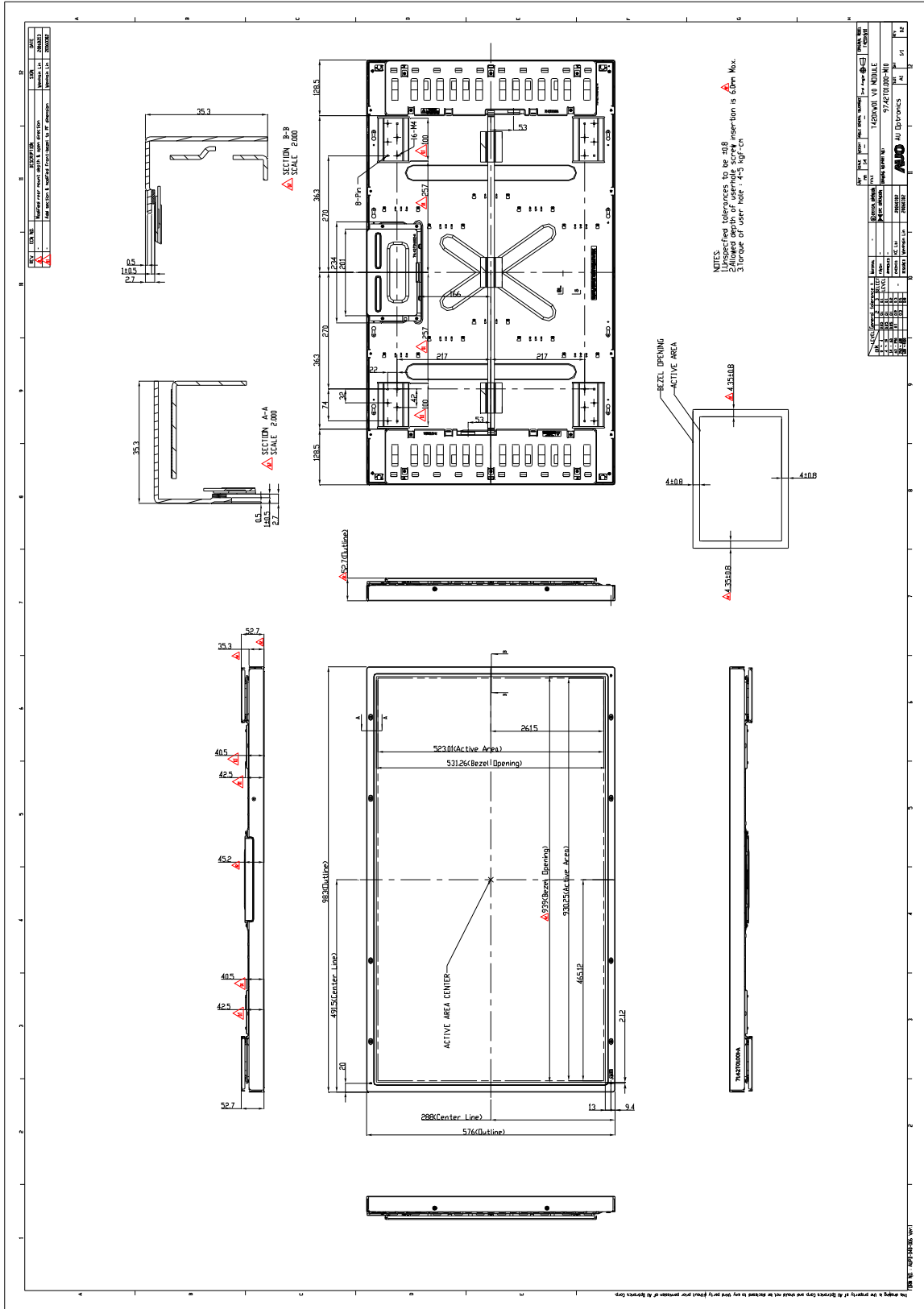



6. International Standard

6-1. Safety

- (1) UL6500, Underwriters Laboratories, Inc. (AUO file number : E204356)
Standard for Safety of Information Technology Equipment Including electrical Business Equipment.
- (2) CAN/CSA C22.2 No. 950-95 Third Edition, Canadian Standards Association, Jan. 28, 1995
Standard for Safety of Information Technology Equipment Including Electrical Business Equipment.
- (3) EN60950 : 1992+A2: 1993+A2: 1993+C3: 1995+A4: 1997+A11: 1997
IEC 950: 1991+A1: 1992+A2: 1993+C3: 1995+A4:1996
IEC 60065
European Committee for Electro technical Standardization (CENELEC)
EUROPEAN STANDARD for Safety of Information Technology Equipment Including Electrical Business Equipment.

6-2. EMC

- a) ANSI C63.4 "Methods of Measurement of Radio-Noise Emissions from Low-Voltage Electrical and Electrical Equipment in the Range of 9kHz to 40GHz. "American National standards Institute(ANSI), 1992
- b) C.I.S.P.R "Limits and Methods of Measurement of Radio Interface Characteristics of Information Technology Equipment." International Special committee on Radio Interference.
- c) EN 55022 "Limits and Methods of Measurement of Radio Interface Characteristics of Information Technology Equipment." European Committee for Electrotechnical Standardization. (CENELEC), 1998



7. Packing

Packing Instruction

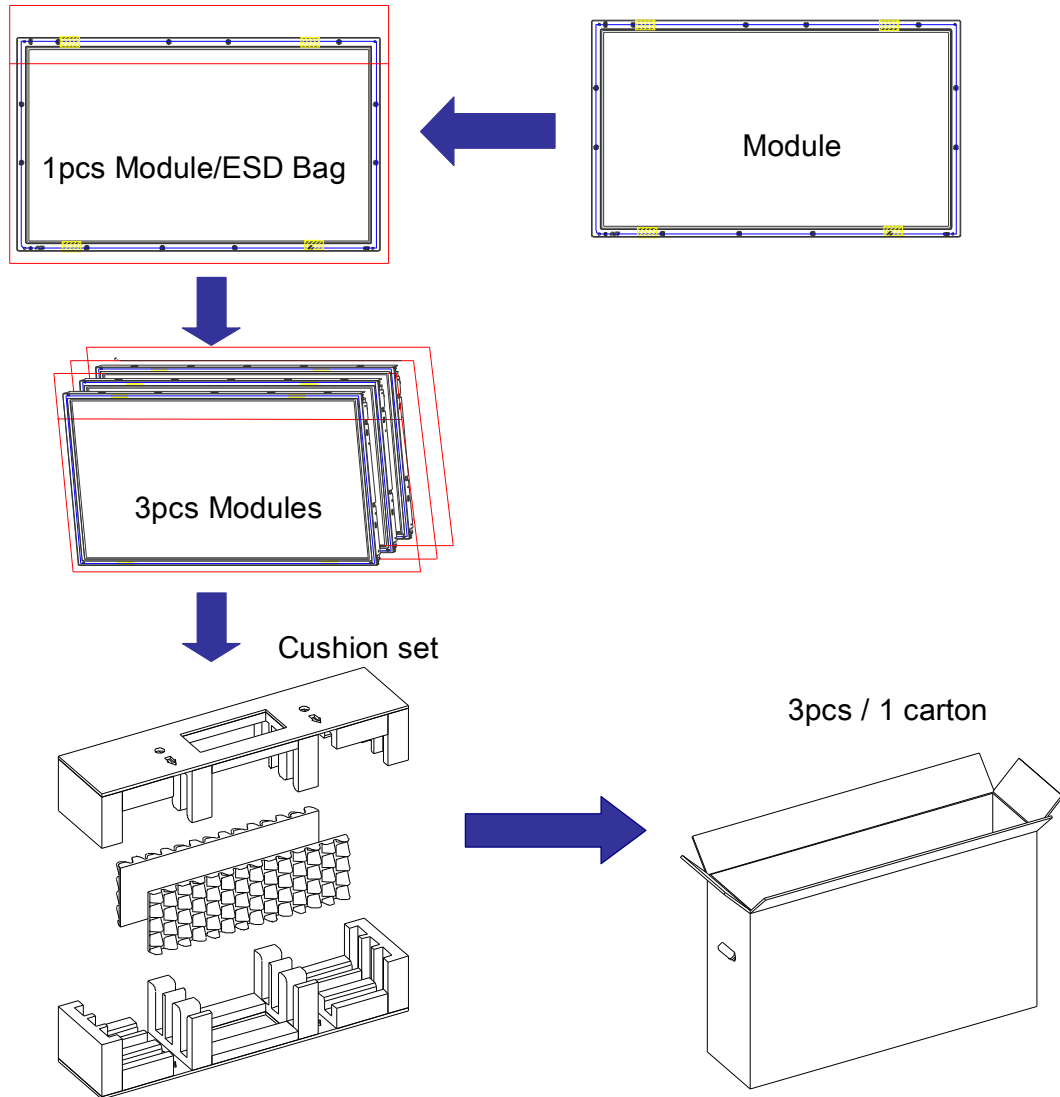



Shipping label



Green Mark Description:

For Pb Free products, AUO will add  for identification.

For RoHS compatible products, AUO will add  for identification.

Note. The Green Mark will be present only when the green documents have been ready by AUO Internal Green Team. (The definition of green design follows the AUO green design checklist.)

Carton label



Pallet information

By air cargo : : (4x1) x2 layers, one pallet put 8 boxes, total 24 pcs module.

By sea : (4x1) x3 layers, one pallet put 12 boxes, total 24 pcs module.

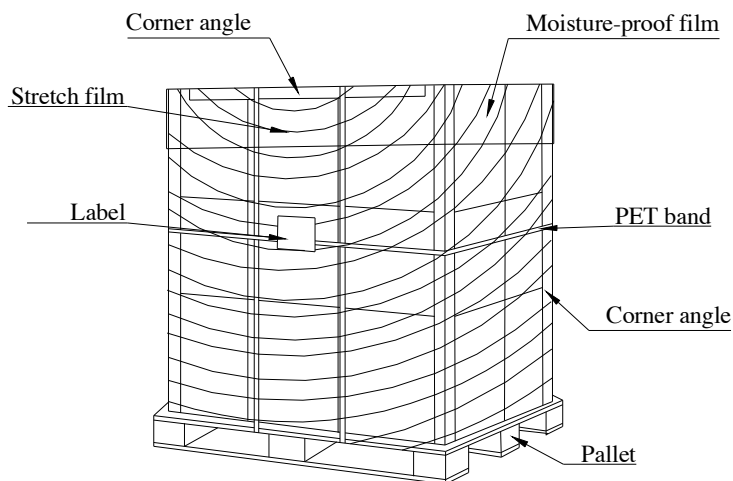



8. PRECAUTIONS

Please pay attention to the followings when you use this TFT LCD module.

8-1 MOUNTING PRECAUTIONS

- (1) You must mount a module using holes arranged on back side of panel
- (2) You should consider the mounting structure so that uneven force (ex. Twisted stress) is not applied to module. And the case on which a module is mounted should have sufficient strength so that external force is not transmitted directly to the module.
- (3) Please attach the surface transparent protective plate to the surface in order to protect the polarizer. Transparent protective plate should have sufficient strength in order to resist external force.
- (4) You should adopt radiation structure to satisfy the temperature specification.
- (5) Acetic acid type and chlorine type materials for the cover case are not desirable because the former generates corrosive gas of attacking the polarizer at high temperature and the latter causes circuit break by electro-chemical reaction.
- (6) Do not touch, push or rub the exposed polarizers with glass, tweezers or anything harder than HB pencil lead. And please do not rub with dust clothes with chemical treatment. Do not touch the surface of polarizer for bare hand or greasy cloth. (Some cosmetics are detrimental to the polarizer.)
- (7) When the surface becomes dusty, please wipe gently with absorbent cotton or other soft materials like chamois soaks with petroleum benzene. Normal-hexane is recommended for cleaning the adhesives used to attach front/ rear polarizers. Do not use acetone, toluene and alcohol because they cause chemical damage to the polarizer.
- (8) Wipe off saliva or water drops as soon as possible. Their long time contact with polarizer causes deformations and color fading.
- (9) Do not open the case because inside circuits do not have sufficient strength.

8-2 OPERATING PRECAUTIONS

- (1) The spike noise causes the mis-operation of circuits. It should be lower than following voltage: $V = \pm 200\text{mV}$ (Over and under shoot voltage)
- (2) Response time depends on the temperature. (In lower temperature, it becomes longer..)
- (3) Brightness depends on the temperature. (In lower temperature, it becomes lower.) And in lower temperature, response time (required time that brightness is stable after turned on) becomes longer.



- (4) Be careful for condensation at sudden temperature change. Condensation makes damage to polarizer or electrical contacted parts. And after fading condensation, smear or spot will occur.
- (5) When fixed patterns are displayed for a long time, remnant image is likely to occur.
- (6) Module has high frequency circuits. Sufficient suppression to the electromagnetic interference shall be done by system manufacturers. Grounding and shielding methods may be important to minimize the interface.

8-3 ELECTROSTATIC DISCHARGE CONTROL

Since a module is composed of electronic circuits, it is not strong to electrostatic discharge. Make certain that treatment persons are connected to ground through wrist band etc. And don't touch interface pin directly.

8-4 PRECAUTIONS FOR STRONG LIGHT EXPOSURE

Strong light exposure causes degradation of polarizer and color filter.

8-5 STORAGE

When storing modules as spares for a long time, the following precautions are necessary.

- (1) Store them in a dark place. Do not expose the module to sunlight or fluorescent light. Keep the temperature between 5°C and 35°C at normal humidity.
- (2) The polarizer surface should not come in contact with any other object. It is recommended that they be stored in the container in which they were shipped.

8-6 HANDLING PRECAUTIONS FOR PROTECTION FILM

- (1) The protection film is attached to the bezel with a small masking tape. When the protection film is peeled off, static electricity is generated between the film and polarizer. This should be peeled off slowly and carefully by people who are electrically grounded and with well ion-blown equipment or in such a condition, etc.
- (2) When the module with protection film attached is stored for a long time, sometimes there remains a very small amount of glue still on the Bezel after the protection film is peeled off.
- (3) You can remove the glue easily. When the glue remains on the Bezel or its vestige is recognized, please wipe them off with absorbent cotton waste or other soft material like chamois soaked with normal-hexane.