

| | |
|--|--|
| Product Description: T460HW03 TFT-LCD PANEL | |
| | |
| AUO Model Name: T460HW03 V4 | |
| Customer Part No. / Project Name: | |
| Customer Signature | AU Optronics Corp. |
| | Approved by: PM Head / Frank Hsu |
| | Reviewed by: RD Head / Hong-Jye Hong |
| | Reviewed by: Project Leader / WK Huang |
| | Prepared by: PM / Ryan Chung |
| Note | |
| | |

Product Functional Specification

**46" Full HD Color TFT-LCD Module
Model Name: T460HW03 V4**

**(*) Preliminary Specification
() Final Specification**

Contents

| No | |
|-----|--------------------------------|
| | CONTENTS |
| | RECORD OF REVISIONS |
| 1 | GENERAL DESCRIPTION |
| 2 | ABSOLUTE MAXIMUM RATINGS |
| 3 | ELECTRICAL SPECIFICATION |
| 3-1 | ELECTRICAL CHARACTERISTICS |
| 3-2 | INTERFACE CONNECTOR |
| 3-3 | SIGNAL TIMING SPECIFICATION |
| 3-4 | SIGNAL TIMING WAVEFORM |
| 3-5 | COLOR INPUT DATA REFERENCE |
| 3-6 | POWER SEQUENCE |
| 3-7 | BACK LIGHT POWER SPECIFICATION |
| 4 | OPTICAL SPECIFICATION |
| 5 | MECHANICAL CHARACTERISTICS |
| 6 | Reliability |
| 7 | INTERNATIONAL STANDARD |
| 8 | PACKING |
| 9 | PRECAUTION |
| | |
| | |
| | |
| | |
| | |
| | |
| | |
| | |

1. General Description

This specification applies to the 46 inch Color TFT-LCD Module T460HW03 V4. This LCD module has a TFT active matrix type liquid crystal panel 1920x1080 pixels, and diagonal size of 46 inch. This module supports Full HD mode (Non-interlace).

Each pixel is divided into Red, Green and Blue sub-pixels or dots which are arranged in vertical stripes. Gray scale or the brightness of the sub-pixel color is determined with a 8-bit gray scale signal for each dot.

The T460HW03 V4 has been designed to apply the 8-bit 2 channel LVDS interface method. It is intended to support displays where high brightness, EBU Gamut (72% NTSC), wide viewing angle, and high color depth are very important.

The T460HW03 V4 backlight unit is using inverter-less solution (inductor type balance board), and need to be powered by integrated power system by customers.

* General Information

| Items | Specification | Unit | Note |
|--------------------|--------------------------------|--------|--------------------|
| Active Screen Size | 46 | inches | Diagonal |
| Display Area | 1018.08(H) x 572.67(V) | mm | |
| Outline Dimension | 1083.0(H) x 627.0(V) x 54.1(D) | mm | With Balance Board |
| Driver Element | a-Si TFT active matrix | | |
| Display Colors | 16.7M | Colors | |
| Color Gamut | 72 | % | NTSC |
| Number of Pixels | 1920 x 1080 | Pixel | |
| Pixel Arrangement | RGB vertical stripe | | |
| Pixel Pitch | 0.53025 | mm | |
| Display Mode | Normally Black | | |
| Surface Treatment | Haze 12%, 3H | | |
| RoHS | RoHS compliance | | |

2. Absolute Maximum Ratings

The followings are maximum values which, if exceeded, may cause faulty operation or damage to the unit

| Item | Symbol | Min. | Max | Unit | Note |
|---------------------------|----------------|------|------|-------------|------|
| Logic/LCD Drive Voltage | V_{DD} | -0.3 | 14.0 | V_{DC} | 1 |
| Input Voltage of Signal | V_{IN} | -0.3 | 3.6 | V_{DC} | 1 |
| Operating Temperature | T_{OP} | 0 | +50 | $^{\circ}C$ | 2 |
| Operating Humidity | H_{OP} | 10 | 90 | %RH | 2 |
| Storage Temperature | T_{ST} | -20 | +60 | $^{\circ}C$ | 2 |
| Storage Humidity | H_{ST} | 10 | 90 | %RH | 2 |
| Panel Surface Temperature | T_{SUR} | -- | +65 | $^{\circ}C$ | 2 |
| Shock (non-operation) | $\pm x, \pm y$ | -- | 40 | G | 3 |
| Shock (non-operation) | $\pm z$ | -- | 30 | G | 3 |
| Vibration (non-operation) | | -- | 1.5 | G | 4 |

Note 1: Duration = 50ms

Note 2: Maximum Wet-Bulb should be 39 $^{\circ}C$ and no condensation. The relative humidity must not exceed 90% non-condensing at temperatures of 40 $^{\circ}C$ or less. At temperatures greater than 40 $^{\circ}C$, the wet bulb temperature must not exceed 39 $^{\circ}C$.

Note 3: Sine wave, 11ms, direction: $\pm x, \pm y, \pm z$ (one time each direction)

Note 4: Wave form: random, vibration level: 1.5G RMS, Bandwidth: 10--300Hz

Duration: X, Y, Z 30min (one time each direction)

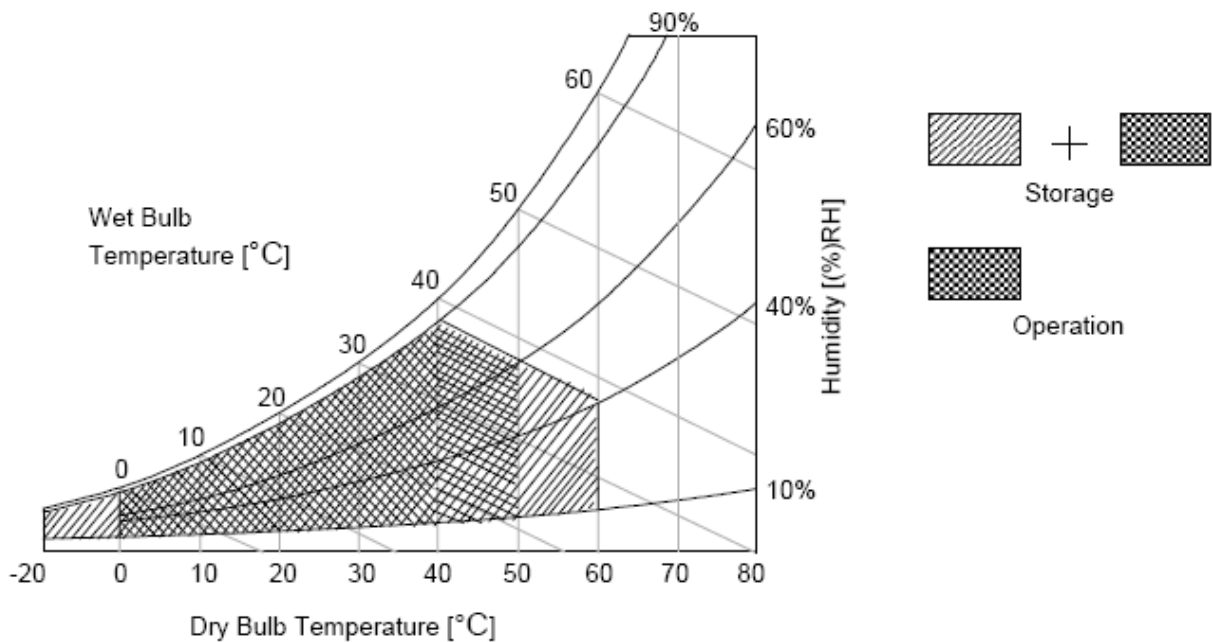

3. Electrical Specification

The T460HW03 V4 requires two power inputs. One is employed to power the LCD electronics and to drive the TFT array and liquid crystal. The second input, which powers the CCFL, is typically generated by an integrate power (I/P) system.

3.1 Electrical Characteristics

| Parameter | | Symbol | Value | | | Unit | Note |
|------------------------------------|---|-----------------|-------|------------|------------|-----------|------|
| | | | Min. | Typ. | Max | | |
| Power Supply Input Voltage | | V_{DD} | 10.8 | 12.0 | 13.2 | V_{DC} | |
| Power Supply Input Current | | I_{DD} | -- | TBD | TBD | A | 1 |
| Power Consumption | | P_C | -- | TBD | TBD | Watt | 1 |
| Inrush Current | | I_{RUSH} | -- | -- | TBD | A | 5 |
| LVDS Interface | Differential Input High Threshold Voltage | V_{TH} | -- | -- | +100 | mV_{DC} | 4 |
| | Differential Input Low Threshold Voltage | V_{TL} | -100 | -- | -- | mV_{DC} | 4 |
| | Common Input Voltage | V_{CIM} | 1.10 | 1.25 | 1.40 | V_{DC} | |
| CMOS Interface | Input High Threshold Voltage | V_{IH} (High) | 2.4 | -- | 3.3 | V_{DC} | |
| | Input Low Threshold Voltage | V_{IL} (Low) | 0 | -- | 0.7 | V_{DC} | |
| Backlight Power Consumption (ref.) | | P_{BL} | -- | 210 | -- | Watt | 2 |
| Life Time | | | 50000 | -- | -- | Hours | 3 |

The performance of the Lamp in LCD panel, for example life time or brightness, is extremely influenced by the characteristics of the balance board and I/P board. All the parameters should be carefully designed as not to produce too much leakage current from high-voltage output. While design or order balance board, please make sure unwanted lighting caused by the mismatch of the lamp and balance board (no lighting, flicker, etc) never occurs. After confirmation, the LCD Panel should be operated in the same condition as installed in your instrument.

Do not attach a conducting tape to lamp connecting wire. If the lamp wire attach to conducting tape, TFT-LCD Module has a low luminance and the inverter has abnormal action, because leakage current occurs between lamp wire and conducting tape.

When operate at low temperatures, the brightness of CCFL will drop and the lifetime of CCFL will be reduced.

Note:

1. $V_{DD}=12.0V$, $f_V=60Hz$, $f_{CLK}=81.5Mhz$, $25^\circ C$, V_{DD} duration time= $400\mu s$, test pattern: white pattern
2. The backlight power consumption shown above is tested by lamp current $I_L=7.6mA$.
3. The life is determined as the time at which luminance of the lamp is 50% compared to that of initial value at the typical lamp current on condition of continuous operating at $25\pm 2^\circ C$.
4. $V_{CIM}=1.25V$

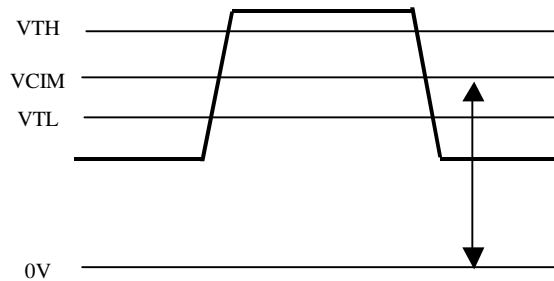
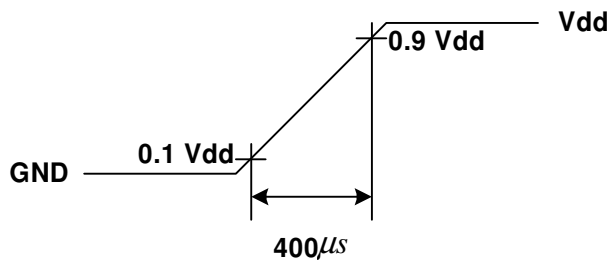

Figure: LVDS Differential Voltage

5. Measurement condition: rising time= $400\mu s$



3.2 Interface Connections

- LCD connector: FI-RE51S-HF (JAE)
- Mating connector: FI-RE51S-HL (JAE)

| PIN # | Signal Name | Description |
|-------|-----------------|---|
| 1 | V _{DD} | Operating voltage supply, +12V DC regulated |
| 2 | V _{DD} | Operating voltage supply, +12V DC regulated |
| 3 | V _{DD} | Operating voltage supply, +12V DC regulated |
| 4 | V _{DD} | Operating voltage supply, +12V DC regulated |
| 5 | V _{DD} | Operating voltage supply, +12V DC regulated |
| 6 | GND | Ground |
| 7 | GND | Ground |
| 8 | GND | Ground |
| 9 | GND | Ground |
| 10 | RO_0- | LVDS Channel 1, pair 0, negative |
| 11 | RO_0+ | LVDS Channel 1, pair 0, positive |
| 12 | RO_1- | LVDS Channel 1, pair 1, negative |
| 13 | RO_1+ | LVDS Channel 1, pair 1, positive |
| 14 | RO_2- | LVDS Channel 1, pair 2, negative |
| 15 | RO_2+ | LVDS Channel 1, pair 2, positive |
| 16 | GND | Ground |
| 17 | RO_CLK- | LVDS Clock, Channel 1, negative |
| 18 | RO_CLK+ | LVDS Clock, Channel 1, positive |
| 19 | GND | Ground |
| 20 | RO_3- | LVDS Channel 1, pair 3, negative |
| 21 | RO_3+ | LVDS Channel 1, pair 3, positive |
| 22 | NC | No Connection |
| 23 | NC | No Connection |
| 24 | GND | Ground |
| 25 | RE_0- | LVDS Channel 2, pair 0, negative |
| 26 | RE_0+ | LVDS Channel 2, pair 0, positive |
| 27 | RE_1- | LVDS Channel 2, pair 1, negative |
| 28 | RE_1+ | LVDS Channel 2, pair 1, positive |
| 29 | RE_2- | LVDS Channel 2, pair 2, negative |
| 30 | RE_2+ | LVDS Channel 2, pair 2, positive |
| 31 | GND | Ground |

| | | |
|----|---------------|--|
| 32 | RE_CLK- | LVDS Clock, Channel 2, negative |
| 33 | RE_CLK+ | LVDS Clock, Channel 2, positive |
| 34 | GND | Ground |
| 35 | RE_3- | LVDS Channel 2, pair 3, negative |
| 36 | RE_3+ | LVDS Channel 2, pair 3, positive |
| 37 | NC | No Connection |
| 38 | NC | No Connection |
| 39 | GND | Ground |
| 40 | NC | No Connection |
| 41 | NC | No Connection |
| 42 | NC | No Connection |
| 43 | NC | No Connection |
| 44 | NC | No Connection |
| 45 | LVDS | Select LVDS data order (NS: High/Open, JEIDA: Low) |
| 46 | NC | No Connection |
| 47 | NC | No Connection |
| 48 | NC (reserved) | No Connection (AUO internal use) |
| 49 | NC (reserved) | No Connection (AUO internal use) |
| 50 | NC (reserved) | No Connection (AUO internal use) |
| 51 | NC (reserved) | No Connection (AUO internal use) |

Note 1: All GND (ground) pins should be connected together and should also be connected to the LCD's metal frame.

Note 2: All V_{DD} (power input) pins should be connected together.

Note 3: All NC (no connection) pins should be open without voltage input.

LVDS Option = High/Open → NS

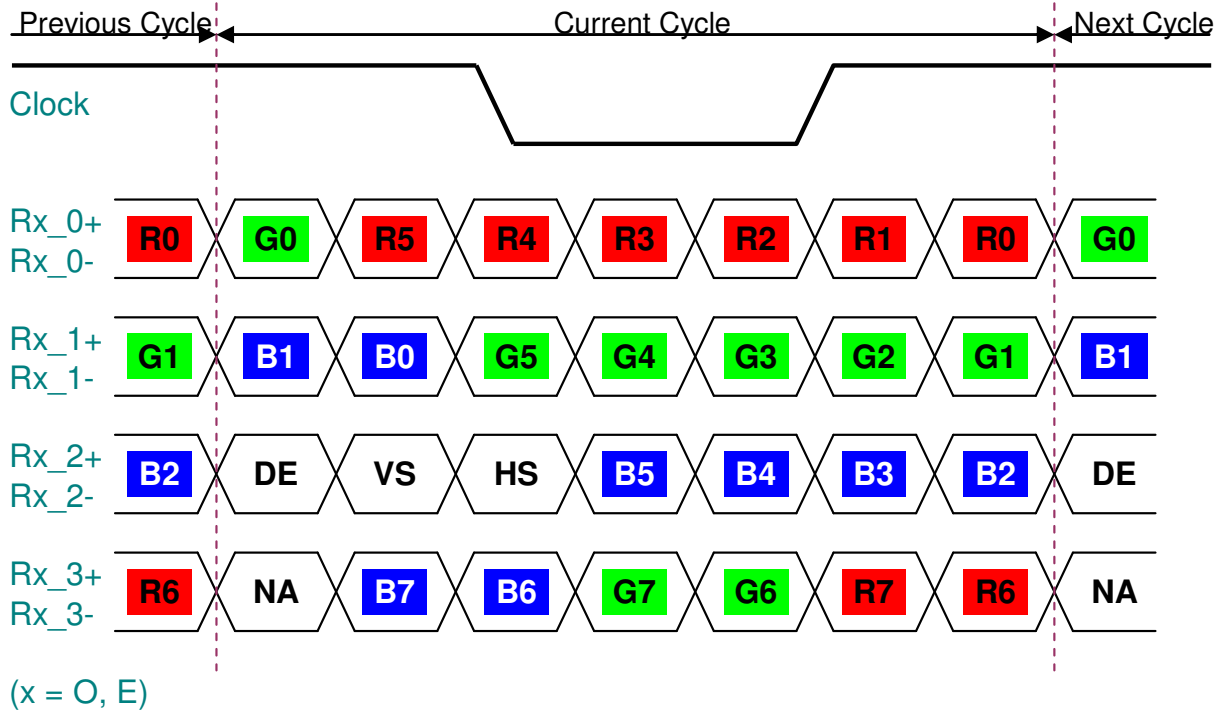

LVDS Option = Low → JEIDA

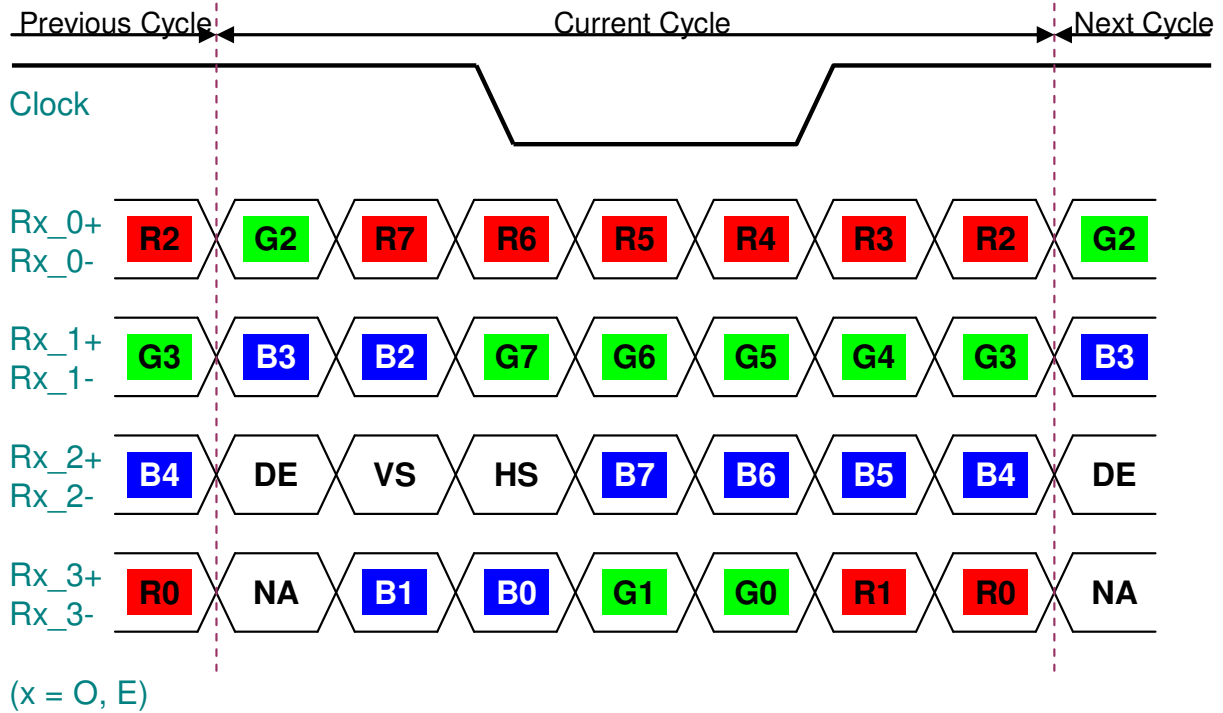

3.3 Signal Timing Specification

This is the signal timing required at the input of the user connector. All of the interface signal timing should be satisfied with the following specifications for its proper operation.

Timing Table (DE only Mode)

Vertical Frequency Range (60Hz)

| Signal | Item | Symbol | Min. | Typ. | Max | Unit |
|----------------------|-----------|----------------|-------|-------|--------|-----------|
| Vertical Section | Period | T_V | 1090 | 1125 | 1480 | T_H |
| | Active | $T_{DISP} (V)$ | 1080 | | | T_H |
| | Blanking | $T_{BLK} (V)$ | 10 | 45 | 400 | T_H |
| Horizontal Section | Period | T_H | 1030 | 1100 | 1300 | T_{CLK} |
| | Active | $T_{DISP} (H)$ | 960 | | | T_{CLK} |
| | Blanking | $T_{BLK} (H)$ | 70 | 140 | 340 | T_{CLK} |
| Clock | Period | T_{CLK} | 11.81 | 13.41 | 14.766 | ns |
| | Frequency | F_{CLK} | 50 | 74.25 | 82 | MHz |
| Vertical Frequency | Frequency | F_V | 47 | 60 | 63 | Hz |
| Horizontal Frequency | Frequency | F_H | 60 | 67.5 | 73 | KHz |

Vertical Frequency Range (50Hz)

| Signal | Item | Symbol | Min. | Typ. | Max | Unit |
|----------------------|-----------|----------------|--------|-------|--------|-----------|
| Vertical Section | Period | T_V | 1330 | 1356 | 1410 | T_H |
| | Active | $T_{DISP} (V)$ | 1080 | | | T_H |
| | Blanking | $T_{BLK} (V)$ | 250 | 276 | 330 | T_H |
| Horizontal Section | Period | T_H | 1090 | 1100 | 1120 | T_{CLK} |
| | Active | $T_{DISP} (H)$ | 960 | | | T_{CLK} |
| | Blanking | $T_{BLK} (H)$ | 130 | 140 | 160 | T_{CLK} |
| Clock | Period | T_{CLK} | 11.958 | 13.41 | 14.677 | ns |
| | Frequency | F_{CLK} | 68.136 | 74.58 | 83.698 | MHz |
| Vertical Frequency | Frequency | F_V | 47 | 50 | 53 | Hz |
| Horizontal Frequency | Frequency | F_H | 62.51 | 67.8 | 74.73 | KHz |

3.4 Signal Timing Waveforms

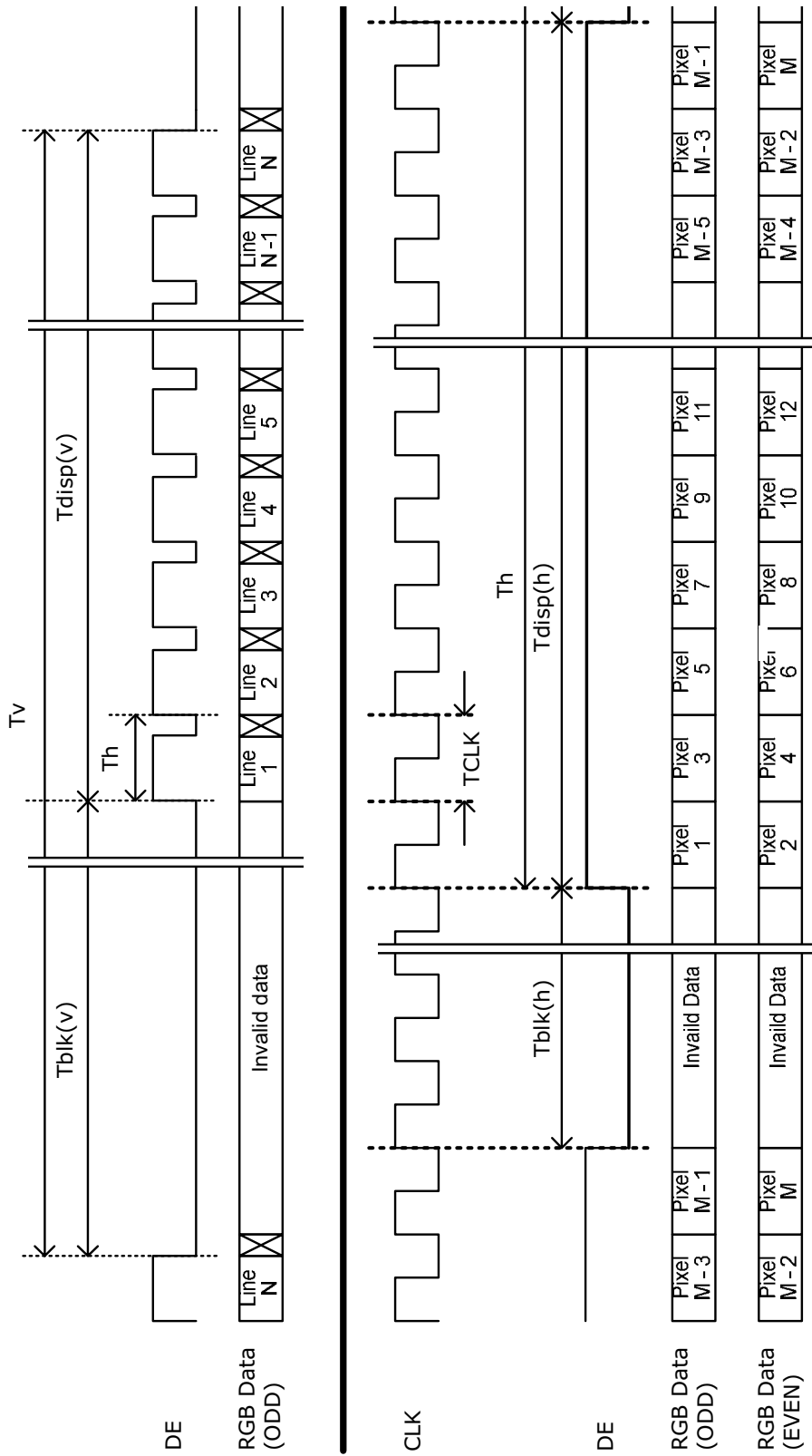



3.5 Color Input Data Reference

The brightness of each primary color (red, green and blue) is based on the 8 bit gray scale data input for the color; the higher the binary input, the brighter the color. The table below provides a reference for color versus data input.

COLOR DATA REFERENCE

| Color | | Input Color Data | | | | | | | | | | | | | | | | | | | | | | | |
|-------------|------------|------------------|----|----|----|-----|----|----|----|-------|----|----|----|-----|----|----|----|------|----|----|----|-----|----|----|----|
| | | RED | | | | | | | | GREEN | | | | | | | | BLUE | | | | | | | |
| | | MSB | | | | LSB | | | | MSB | | | | LSB | | | | MSB | | | | LSB | | | |
| | | R7 | R6 | R5 | R4 | R3 | R2 | R1 | R0 | G7 | G6 | G5 | G4 | G3 | G2 | G1 | G0 | B7 | B6 | B5 | B4 | B3 | B2 | B1 | B0 |
| Basic Color | Black | 0 | 0 | 0 | 0 | 0 | 0 | 0 | 0 | 0 | 0 | 0 | 0 | 0 | 0 | 0 | 0 | 0 | 0 | 0 | 0 | 0 | 0 | 0 | 0 |
| | Red(255) | 1 | 1 | 1 | 1 | 1 | 1 | 1 | 1 | 0 | 0 | 0 | 0 | 0 | 0 | 0 | 0 | 0 | 0 | 0 | 0 | 0 | 0 | 0 | |
| | Green(255) | 0 | 0 | 0 | 0 | 0 | 0 | 0 | 0 | 1 | 1 | 1 | 1 | 1 | 1 | 1 | 0 | 0 | 0 | 0 | 0 | 0 | 0 | 0 | |
| | Blue(255) | 0 | 0 | 0 | 0 | 0 | 0 | 0 | 0 | 0 | 0 | 0 | 0 | 0 | 0 | 0 | 1 | 1 | 1 | 1 | 1 | 1 | 1 | 1 | |
| | Cyan | 0 | 0 | 0 | 0 | 0 | 0 | 0 | 0 | 1 | 1 | 1 | 1 | 1 | 1 | 1 | 1 | 1 | 1 | 1 | 1 | 1 | 1 | 1 | |
| | Magenta | 1 | 1 | 1 | 1 | 1 | 1 | 1 | 1 | 0 | 0 | 0 | 0 | 0 | 0 | 0 | 1 | 1 | 1 | 1 | 1 | 1 | 1 | 1 | |
| | Yellow | 1 | 1 | 1 | 1 | 1 | 1 | 1 | 1 | 1 | 1 | 1 | 1 | 1 | 1 | 1 | 0 | 0 | 0 | 0 | 0 | 0 | 0 | 0 | |
| | White | 1 | 1 | 1 | 1 | 1 | 1 | 1 | 1 | 1 | 1 | 1 | 1 | 1 | 1 | 1 | 1 | 1 | 1 | 1 | 1 | 1 | 1 | 1 | |
| RED | RED(000) | 0 | 0 | 0 | 0 | 0 | 0 | 0 | 0 | 0 | 0 | 0 | 0 | 0 | 0 | 0 | 0 | 0 | 0 | 0 | 0 | 0 | 0 | | |
| | RED(001) | 0 | 0 | 0 | 0 | 0 | 0 | 1 | 0 | 0 | 0 | 0 | 0 | 0 | 0 | 0 | 0 | 0 | 0 | 0 | 0 | 0 | 0 | | |
| | ---- | | | | | | | | | | | | | | | | | | | | | | | | |
| | RED(254) | 1 | 1 | 1 | 1 | 1 | 1 | 0 | 0 | 0 | 0 | 0 | 0 | 0 | 0 | 0 | 0 | 0 | 0 | 0 | 0 | 0 | 0 | | |
| | RED(255) | 1 | 1 | 1 | 1 | 1 | 1 | 1 | 0 | 0 | 0 | 0 | 0 | 0 | 0 | 0 | 0 | 0 | 0 | 0 | 0 | 0 | 0 | | |
| GREEN | GREEN(000) | 0 | 0 | 0 | 0 | 0 | 0 | 0 | 0 | 0 | 0 | 0 | 0 | 0 | 0 | 0 | 0 | 0 | 0 | 0 | 0 | 0 | 0 | | |
| | GREEN(001) | 0 | 0 | 0 | 0 | 0 | 0 | 0 | 0 | 0 | 0 | 0 | 0 | 0 | 1 | 0 | 0 | 0 | 0 | 0 | 0 | 0 | 0 | | |
| | ---- | | | | | | | | | | | | | | | | | | | | | | | | |
| | GREEN(254) | 0 | 0 | 0 | 0 | 0 | 0 | 0 | 1 | 1 | 1 | 1 | 1 | 1 | 0 | 0 | 0 | 0 | 0 | 0 | 0 | 0 | 0 | | |
| | GREEN(255) | 0 | 0 | 0 | 0 | 0 | 0 | 0 | 1 | 1 | 1 | 1 | 1 | 1 | 1 | 0 | 0 | 0 | 0 | 0 | 0 | 0 | 0 | | |
| BLUE | BLUE(000) | 0 | 0 | 0 | 0 | 0 | 0 | 0 | 0 | 0 | 0 | 0 | 0 | 0 | 0 | 0 | 0 | 0 | 0 | 0 | 0 | 0 | 0 | | |
| | BLUE(001) | 0 | 0 | 0 | 0 | 0 | 0 | 0 | 0 | 0 | 0 | 0 | 0 | 0 | 0 | 0 | 0 | 0 | 0 | 0 | 0 | 0 | 1 | | |
| | ----- | | | | | | | | | | | | | | | | | | | | | | | | |
| | BLUE(254) | 0 | 0 | 0 | 0 | 0 | 0 | 0 | 0 | 0 | 0 | 0 | 0 | 0 | 0 | 1 | 1 | 1 | 1 | 1 | 1 | 1 | 0 | | |
| | BLUE(255) | 0 | 0 | 0 | 0 | 0 | 0 | 0 | 0 | 0 | 0 | 0 | 0 | 0 | 0 | 1 | 1 | 1 | 1 | 1 | 1 | 1 | 1 | | |

3.6 Power Sequence

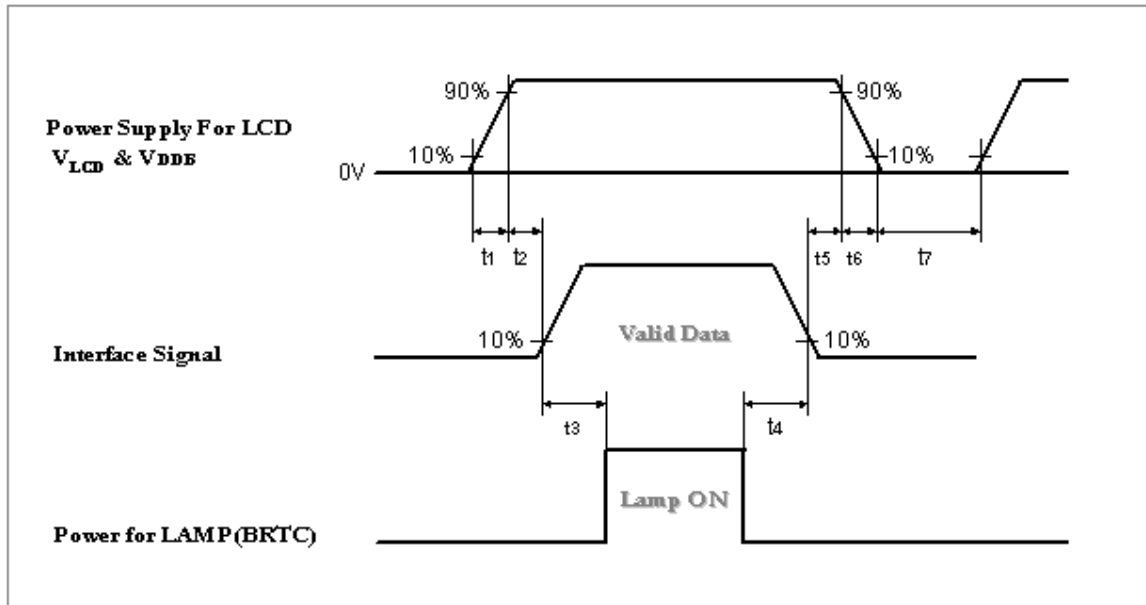

| Parameter | Values | | | Unit |
|-----------|--------|------|------|------|
| | Min. | Typ. | Max. | |
| t1 | 0.4 | -- | 30 | ms |
| t2 | 0.1 | -- | 50 | ms |
| t3 | 300 | -- | -- | ms |
| t4 | 10 | -- | -- | ms |
| t5 | 0.1 | -- | 50 | ms |
| t6 | -- | -- | 300 | ms |
| t7 | 1000 | -- | -- | ms |

Apply the lamp voltage within the LCD operating range. When the backlight turns on before the LCD operation or the LCD turns off before the backlight turns off, the display may momentarily become abnormal.

Caution: The above on/off sequence should be applied to avoid abnormal function in the display. In case of handling, make sure to turn off the power when you plug the cable into the input connector or pull the cable out of the connector.

3.7 Backlight Power Specification

Specification (TBD)

(Ta=25±5°C, Turn-on after 60mins)

| | Item | Symbol | Specification | | | Unit | Note |
|---|--------------------------|------------------|---------------|------|-----|-------------------|--------------------------------------|
| | | | Min. | Typ. | Max | | |
| 1 | High Voltage (HV) Input | HV1/ HV2 | 500 | 700 | 900 | V _{RMS} | |
| 2 | Input Current of each HV | I _{HV} | 68 | 74 | 80 | mA _{RMS} | I _L =6.0mA _{RMS} |
| 3 | High Voltage (HV) Output | V _{OUT} | 1000 | | -- | V _{RMS} | |
| 4 | Output Lamp Current | I _{OUT} | TBD | 7.6 | TBD | mA _{RMS} | PWM=100% |
| 5 | Operating Frequency | F _{OP} | ?? | 55.5 | ?? | KHz | (Recommend) |
| 6 | PWM Dimming Frequency | F _{PWM} | ?? | 150 | ?? | Hz | (Recommend) |
| 7 | Dimming Duty Ratio | D _{PWM} | 20 | -- | 100 | % | (Recommend) |
| 8 | Lamp Type | | Straight | | | | |
| 9 | Number of Lamps | | 18 | | | pcs | |

Protection Circuit (Feedback Signal):

| | | | | | | | |
|----|-------------------------|--------------------|------|------|------|------------------|------------------------|
| 10 | Supply Voltage | V _{CC} | 10 | 12 | 15 | V _{DC} | |
| 11 | Supply Current | I _{CC} | -- | 20 | 40 | mA _{DC} | |
| 12 | Current Feedback Signal | V _{FB} | 2.0 | 2.20 | 2.4 | V _{RMS} | |
| 13 | Lamp Detection (OLP) | V _{LD(H)} | 11.4 | 12 | 12.6 | V _{DC} | Lamp normal status |
| | | V _{LD(L)} | 0 | -- | 0.8 | V _{DC} | Lamp protection status |

Lamp Specification:

| | | | | | | | |
|----|------------------------|-------------------|------|------|------|-------------------|---|
| 14 | Output Working Voltage | V _L | 1107 | 1230 | 1353 | V _{RMS} | I _L =10.0mA _{RMS} , Ta=25°C |
| 15 | Output Current | I _L | 4 | 10.0 | 10.5 | mA _{RMS} | |
| 16 | Lamp Frequency | F _{LAMP} | 40 | -- | 80 | KHz | |
| 17 | Starting Voltage | V _s | -- | -- | 2200 | V _{RMS} | Ta=25°C |
| | | | -- | -- | 2450 | V _{RMS} | Ta=0°C |

Connector Pin Assignment

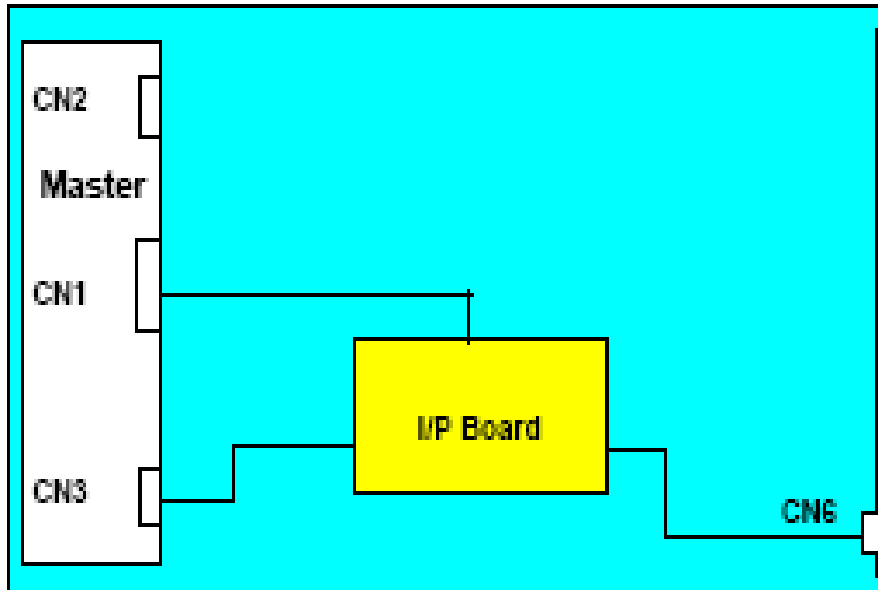

CN2 or CN3: YeonHO_130001WR-02E (LF)

| PIN # | Symbol | Description |
|-------|--------|-------------------------------|
| 1 | HV1+ | I/P board high voltage supply |
| 2 | HV1+ | I/P board high voltage supply |

CN6: YeonHO_130001WR-02E (LF)

| PIN # | Symbol | Description |
|-------|--------|-------------------------------|
| 1 | HV2 - | I/P board high voltage supply |
| 2 | HV2- | I/P board high voltage supply |

CN1: HIROSE_KN30-7P-1.25H

| PIN # | Symbol | Description |
|-------|--------|--|
| 1 | VCC | Power Supply for Protection Circuit |
| 2 | IFB | Lamp Current feedback Signal (Full wave current) |
| 3 | IFB | Lamp Current feedback Signal (Full wave current) |
| 4 | GND | Signal Ground |
| 5 | GND | Signal Ground |
| 6 | LD | Lamp detection |
| 7 | LD | Lamp detection |

4. Optical Specification

Optical characteristics are determined after the unit has been 'ON' and stable for approximately 60 minutes in a dark environment at 25°C. The values specified are at an approximate distance 500mm from the LCD surface at a viewing angle of φ and θ equal to 0°.

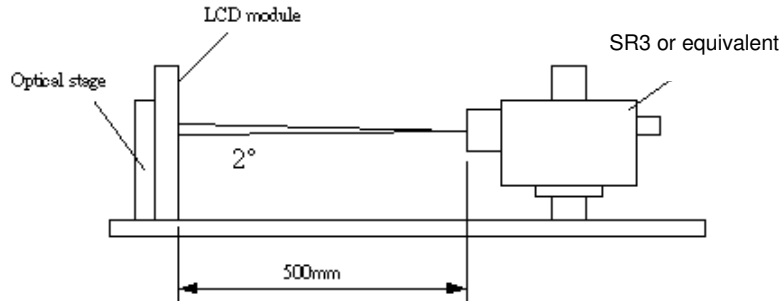

| Parameter | Symbol | Values | | | Unit | Notes |
|--------------------------------------|----------------------|-----------|-------|-----------|-------------------|---------------------|
| | | Min. | Typ. | Max | | |
| Contrast Ratio | CR | 3500 | 4000 | -- | | 1 |
| Surface Luminance (White) | L_{WH} | 400 | 500 | -- | cd/m ² | 2 |
| Luminance Variation | $\delta_{WHITE(9P)}$ | -- | -- | 1.3 | | 3 |
| Response Time (Average) | T _γ | -- | 6.5 | -- | ms | 4 (Gray to Gray) |
| Color Coordinates | | | | | | |
| Red | R _x | Typ.-0.03 | 0.640 | Typ.+0.03 | | |
| | R _y | | 0.330 | | | |
| Green | G _x | | 0.290 | | | |
| | G _y | | 0.600 | | | |
| Blue | B _x | | 0.150 | | | |
| | B _y | | 0.060 | | | |
| White | W _x | | 0.280 | | | |
| | W _y | 0.290 | | | | |
| Viewing Angle | | | | | | |
| | | | | | | (Contrast Ratio>10) |
| x axis, right($\varphi=0^\circ$) | θ_r | -- | 89 | -- | degree | 5 |
| x axis, left($\varphi=180^\circ$) | θ_l | -- | 89 | -- | degree | 5 |
| y axis, up($\varphi=90^\circ$) | θ_u | -- | 89 | -- | degree | 5 |
| y axis, down ($\varphi=270^\circ$) | θ_d | -- | 89 | -- | degree | 5 |

Note:

1. Contrast Ratio (CR) is defined mathematically as:

$$\text{Contrast Ratio (CR)} = \frac{\text{Brightness of the "white" state}}{\text{Brightness of the "black" state}}$$

2. Surface Luminance is luminance value at point 5 with 100% dimming across the LCD surface 50cm from the surface with all pixels displaying white. For more information see Fig. 4-2. When lamp current $I_L=7.6\text{mA}$, $L_{WH}=L_{on5}$, where L_{on5} is the luminance with all pixels displaying white at center 5 location.

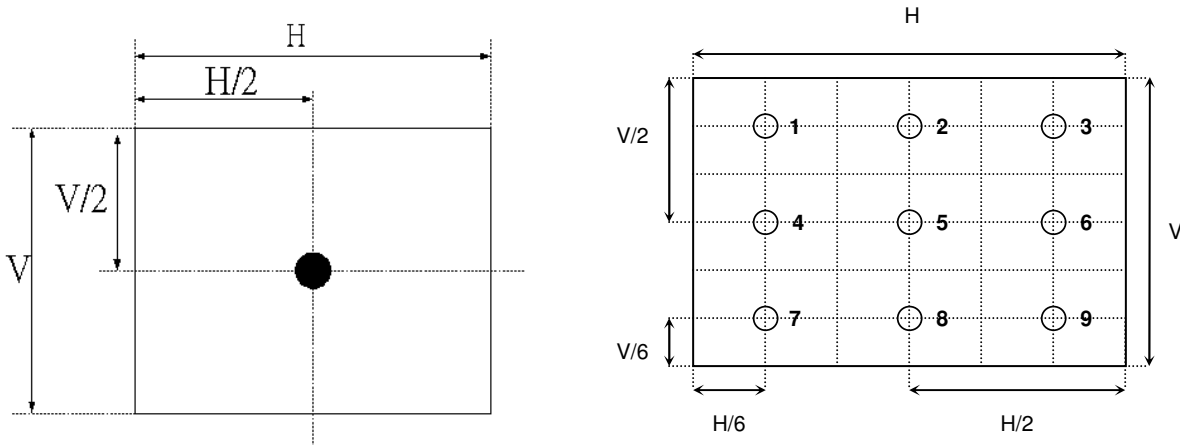

Fig.4-2 Optical measurement point

3. The variation in surface luminance, $\delta_{\text{WHITE}(9P)}$ is defined under brightness of $I_L=7.6\text{mA}$ as:

$$\delta_{\text{WHITE}(9P)} = \text{Maximum}(L_{on1}, L_{on2}, \dots, L_{on9}) / \text{Minimum}(L_{on1}, L_{on2}, \dots, L_{on9})$$

4. Response time T_γ is the average time required for display transition by switching the input signal for five luminance ratio (0%, 25%, 50%, 75%, 100% brightness matrix) and is based on $f_v=60\text{Hz}$ to optimize.

| | 0% | 25% | 50% | 75% | 100% |
|------|-----------|------------|------------|------------|------------|
| 0% | | t:0%-25% | t:0%-50% | t:0%-75% | t:0%-100% |
| 25% | t:25%-0% | | t:25%-50% | t:25%-75% | t:25%-100% |
| 50% | t:50%-0% | t:50%-25% | | t:50%-75% | t:50%-100% |
| 75% | t:75%-0% | t:75%-25% | t:75%-50% | | t:75%-100% |
| 100% | t:100%-0% | t:100%-25% | t:100%-50% | t:100%-75% | |

5. Viewing angle is the angle at which the contrast ratio is greater than 10. The angles are determined for the horizontal (or x-axis) and the vertical (or y-axis) with respect to the z-axis which is normal to the LCD surface. For more information see Fig. 4-4.

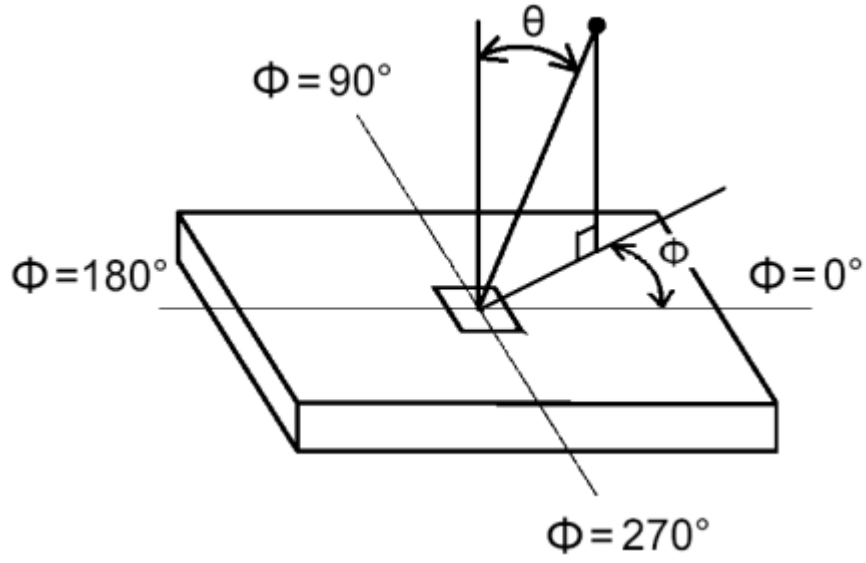

Fig.4-4 Viewing angle definition

5. Mechanical Characteristics

The contents provide general mechanical characteristics for the model T460HW03. In addition the figures in the next page are detailed mechanical drawing of the LCD.

| | | |
|---------------------|-------------------|------------------------------|
| Outline Dimension | Horizontal (typ.) | 1083.0 mm |
| | Vertical (typ.) | 627.0 mm |
| | Depth (typ.) | 54.1 mm (with balance board) |
| Bezel Area | Horizontal (typ.) | 1024.4 mm |
| | Vertical (typ.) | 578.6 mm |
| Active Display Area | Horizontal | 1018.08 mm |
| | Vertical | 572.67 mm |
| Weight | 15500g (Max) | |
| Surface Treatment | Haze 12%, 3H | |

6. Reliability

Panel condition in RA test

Brightness: 500nits

Lamp Current (Hot side): 7.6mA

| No | Test Item | Condition |
|----|-----------------------------------|--|
| 1 | High temperature storage test | Ta=60°C 300h |
| 2 | Low temperature storage test | Ta= -20°C 300h |
| 3 | High temperature operation test | Ta=50°C 300h |
| 4 | Low temperature operation test | Ta=-5°C 300h |
| 5 | Vibration test (non-operating) | Wave form: random Vibration level: 1.5G RMS Bandwidth: 10-300Hz, Duration: X, Y, Z 30min One time each direction |
| 6 | Shock test (non-operating) | Shock level: 50G Waveform: half sine wave, 11ms Direction: ±X, ±Y, ±Z One time each direction |
| 7 | Vibration test (with carton) | Wave form: random Vibration level: 1.5G RMS Bandwidth: 10-200Hz, Duration: X, Y, Z 30min One time each direction |
| 8 | Drop test (with carton) | Height: 25.4cm 1 corner, 3 edges, 6 surfaces (ASTMD4169-I) |

Result Evaluation Criteria }

There should be no change which might affect the practical display function when the display quality test is conducted under normal operating condition.

7. International Standard

7-1. Safety

- (1) UL6500, UL 60065 Underwriters Laboratories, Inc. (AUO file number: E204356)
Standard for Safety of Information Technology Equipment Including electrical Business Equipment.
- (2) CAN/CSA C22.2 No. 950-95 Third Edition, Canadian Standards Association, Jan. 28, 1995
Standard for Safety of Information Technology Equipment Including Electrical Business Equipment.
- (3) EN60950: 1992+A2: 1993+A2: 1993+C3: 1995+A4: 1997+A11: 1997
IEC 950: 1991+A1: 1992+A2: 1993+C3: 1995+A4:1996
IEC 60065: version 7th
European Committee for Electro technical Standardization (CENELEC)
EUROPEAN STANDARD for Safety of Information Technology Equipment Including Electrical Business Equipment.

7-2. EMC

- (1) ANSI C63.4 "Methods of Measurement of Radio-Noise Emissions from Low-Voltage Electrical and Electrical Equipment in the Range of 9kHz to 40GHz. "American National standards Institute(ANSI), 1992
- (2) C.I.S.P.R "Limits and Methods of Measurement of Radio Interface Characteristics of Information Technology Equipment." International Special committee on Radio Interference.
- (3) EN 55022 "Limits and Methods of Measurement of Radio Interface Characteristics of Information Technology Equipment." European Committee for Electrotechnical Standardization. (CENELEC), 1998

7-3. Green Mark Description

- (1) For Pb Free products, AUO will add  for identification.
- (2) For RoHS compatible products, AUO will add RoHS for identification.

Note. The Green Mark will be present only when the green documents have been ready by AUO Internal Green Team. (The definition of green design follows the AUO green design checklist.)

8. Packing

Packing Instruction

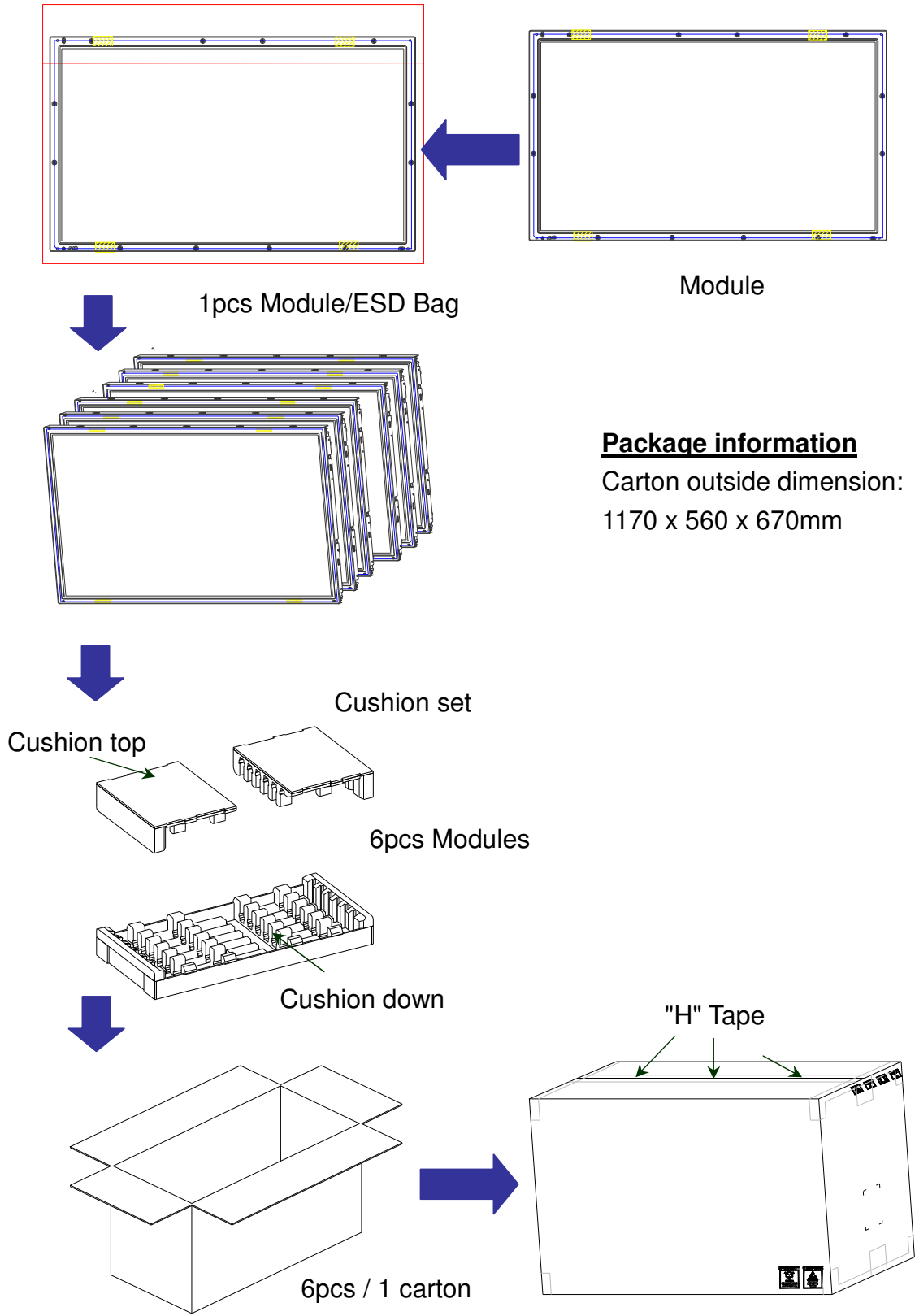

Package information

Carton outside dimension:
1170 x 560 x 670mm

Pallet information

By air cargo: (2 x 1) x 1 layers, one pallet put 2 boxes, total 12 pcs module.

Dimension: 1140 x 1180 x 810mm

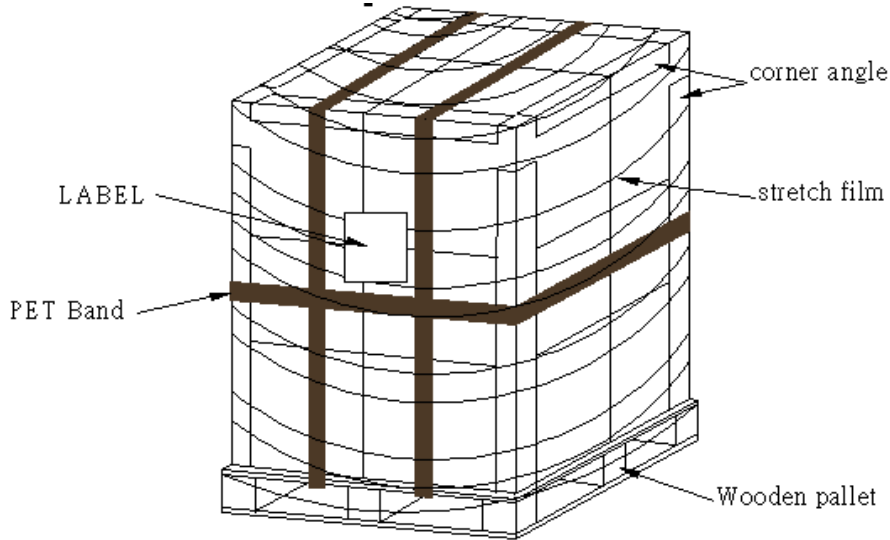

By sea: (2 x 1) x 2 layers, one pallet put 2 boxes, stack 2 layers, total 24 pcs module.

Dimension: 1140 x 1180 x 1620mm

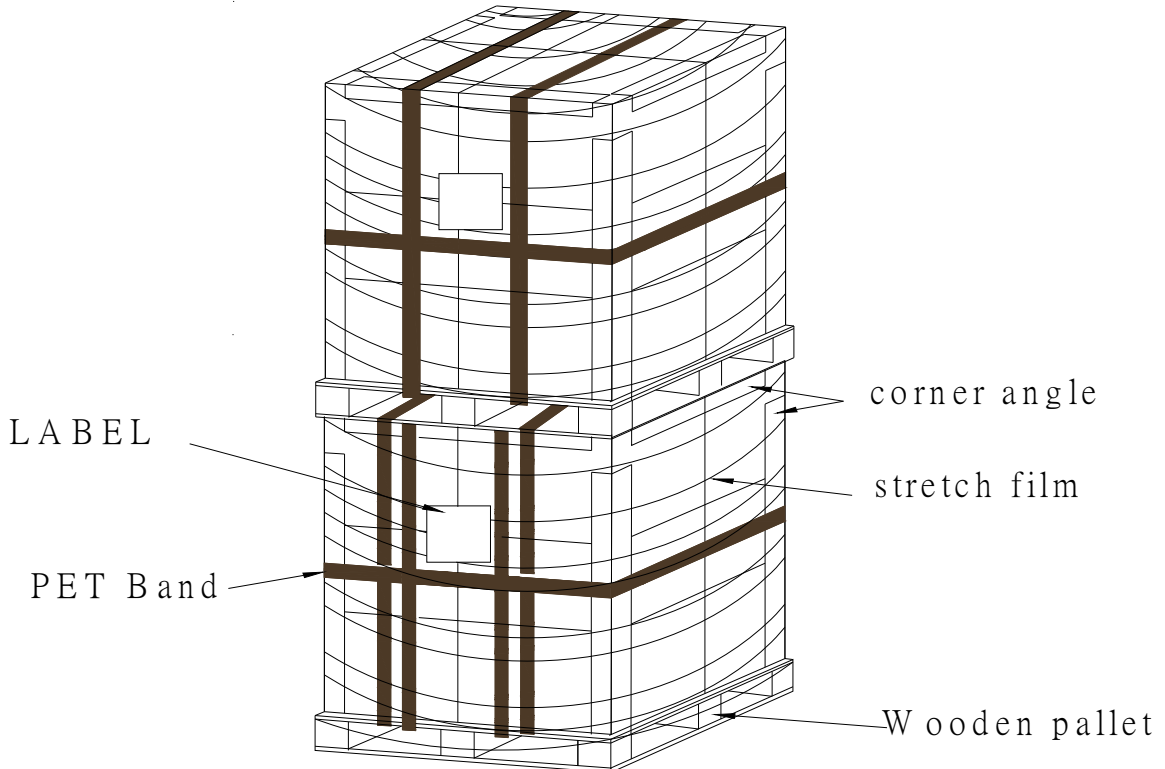

Pallet dimension: 1140 x 1180 x 138mm

Panel Label

| | | | | |
|---|---|---|---|---|
|  | Manufactured XX/XX Model No T460HW03 V4 AU Optronics XXXXG MADE IN CHINA (S11) |  |  |  |
|  AUXXXXXXXXXXXXXXXXXXXXX | |  | | |

Carton Label

| | | |
|-----------------------|--|---|
| AU Optronics |  |  |
| MODEL NO: T460HW03 V4 | QTY:6 | |
| PART NO: 97.46T03.XXX | | |
| CUSTOMER NO: | | |
| CARTON NO: |  | |
| Made in XXXXXX | * XXXXXX - XXXXXXXXXXXX * | |

9. Precautions

Please pay attention to the followings when you use this TFT LCD module.

8-1 MOUNTING PRECAUTIONS

- (1) You must mount a module using holes arranged on back side of panel
- (2) You should consider the mounting structure so that uneven force (ex. Twisted stress) is not applied to module. And the case on which a module is mounted should have sufficient strength so that external force is not transmitted directly to the module.
- (3) Please attach the surface transparent protective plate to the surface in order to protect the polarizer. Transparent protective plate should have sufficient strength in order to resist external force.
- (4) You should adopt radiation structure to satisfy the temperature specification.
- (5) Acetic acid type and chlorine type materials for the cover case are not desirable because the former generates corrosive gas of attacking the polarizer at high temperature and the latter causes circuit break by electro-chemical reaction.
- (6) Do not touch, push or rub the exposed polarizers with glass, tweezers or anything harder than HB pencil lead. And please do not rub with dust clothes with chemical treatment. Do not touch the surface of polarizer for bare hand or greasy cloth. (Some cosmetics are detrimental to the polarizer.)
- (7) When the surface becomes dusty, please wipe gently with absorbent cotton or other soft materials like chamois soaks with petroleum benzene. Normal-hexane is recommended for cleaning the adhesives used to attach front/ rear polarizers. Do not use acetone, toluene and alcohol because they cause chemical damage to the polarizer.
- (8) Wipe off saliva or water drops as soon as possible. Their long time contact with polarizer causes deformations and color fading.
- (9) Do not open the case because inside circuits do not have sufficient strength.

8-2 OPERATING PRECAUTIONS

- (1) The spike noise causes the mis-operation of circuits. It should be lower than following voltage:
 $V = \pm 200\text{mV}$ (Over and under shoot voltage)
- (2) Response time depends on the temperature. (In lower temperature, it becomes longer.)
- (3) Brightness depends on the temperature. (In lower temperature, it becomes lower.) And in lower temperature, response time (required time that brightness is stable after turned on) becomes longer.
- (4) Be careful for condensation at sudden temperature change. Condensation makes damage to polarizer or electrical contacted parts. And after fading condensation, smear or spot will occur.
- (5) When fixed patterns are displayed for a long time, remnant image is likely to occur.
- (6) Module has high frequency circuits. Sufficient suppression to the electromagnetic interference shall be done by system manufacturers. Grounding and shielding methods may be important to minimize the interface.
- (7) The device listed in the product specification sheets was designed and manufactured for TV application.

8-3 ELECTROSTATIC DISCHARGE CONTROL

Since a module is composed of electronic circuits, it is not strong to electrostatic discharge. Make certain that treatment persons are connected to ground through wrist band etc. And don't touch interface pin directly.

8-4 PRECAUTIONS FOR STRONG LIGHT EXPOSURE

Strong light exposure causes degradation of polarizer and color filter.

8-5 STORAGE

When storing modules as spares for a long time, the following precautions are necessary.

- (1) Store them in a dark place. Do not expose the module to sunlight or fluorescent light. Keep the temperature between 5°C and 35°C at normal humidity.
- (2) The polarizer surface should not come in contact with any other object. It is recommended that they be stored in the container in which they were shipped.

8-6 HANDLING PRECAUTIONS FOR PROTECTION FILM

- (1) The protection film is attached to the bezel with a small masking tape. When the protection film is peeled off, static electricity is generated between the film and polarizer. This should be peeled off slowly and carefully by people who are electrically grounded and with well ion-blown equipment or in such a condition, etc.
- (2) When the module with protection film attached is stored for a long time, sometimes there remains a very small amount of flue still on the Bezel after the protection film is peeled off.
- (3) You can remove the glue easily. When the glue remains on the Bezel or its vestige is recognized, please wipe them off with absorbent cotton waste or other soft material like chamois soaked with normal-hexane.